

1

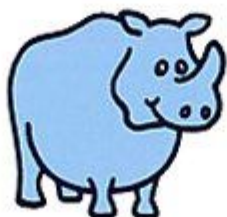

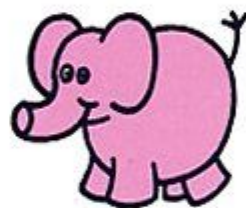

1

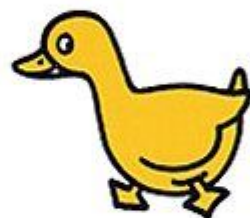
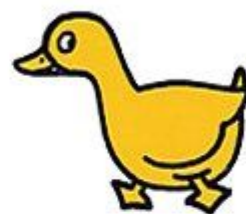
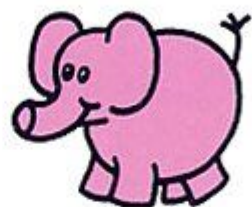
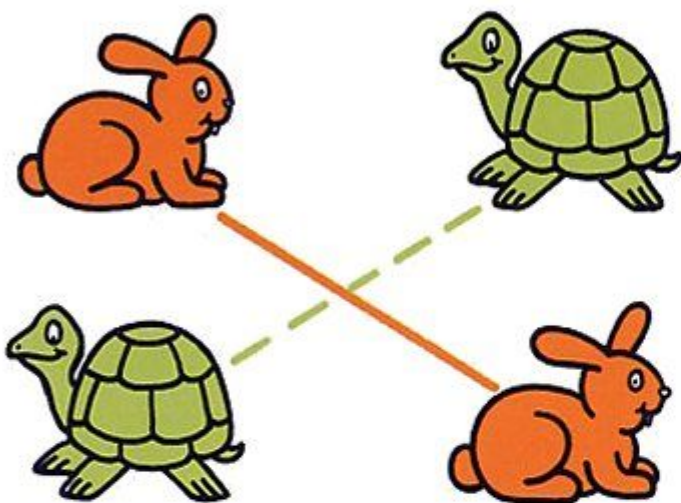
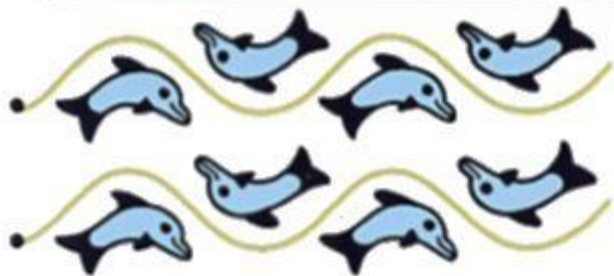
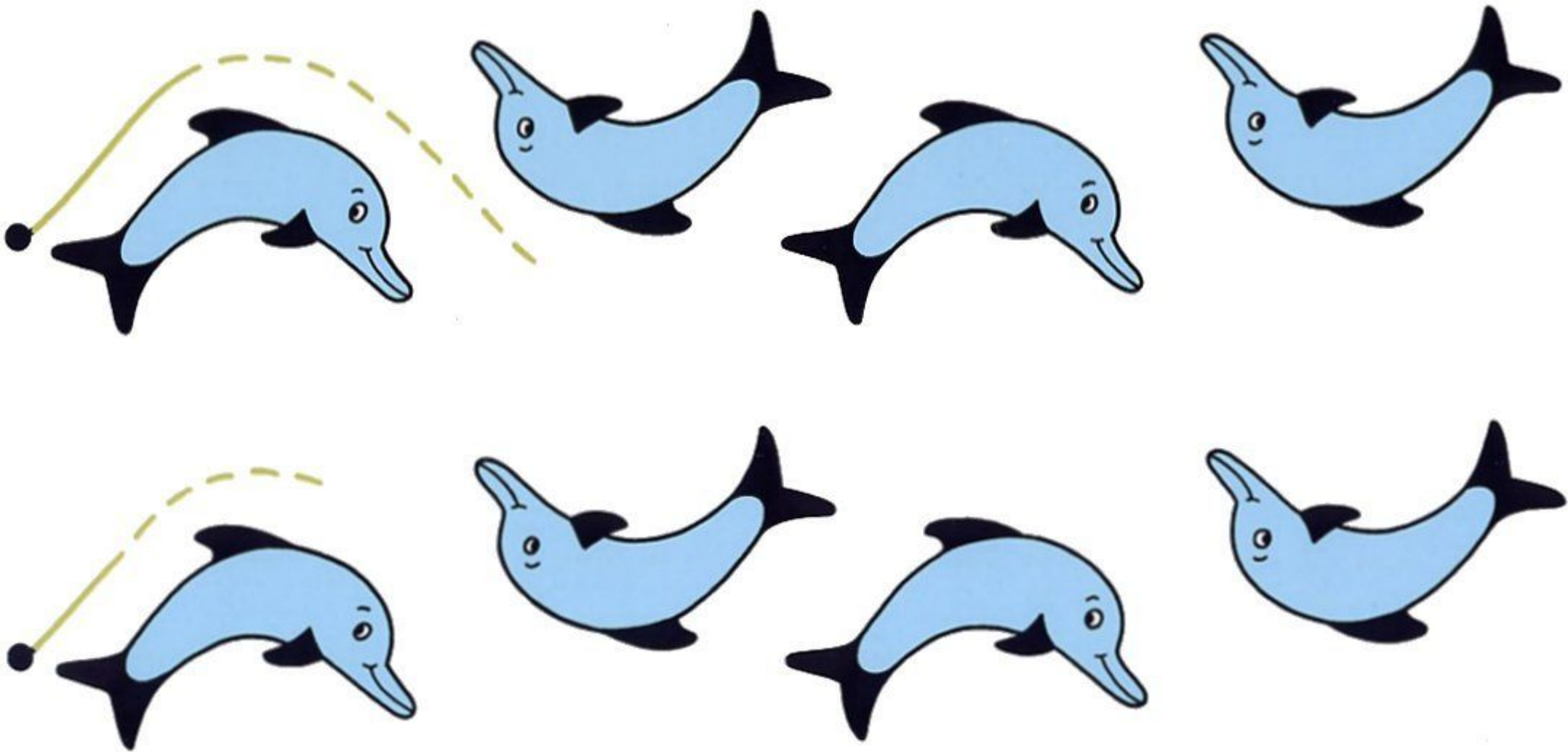



1

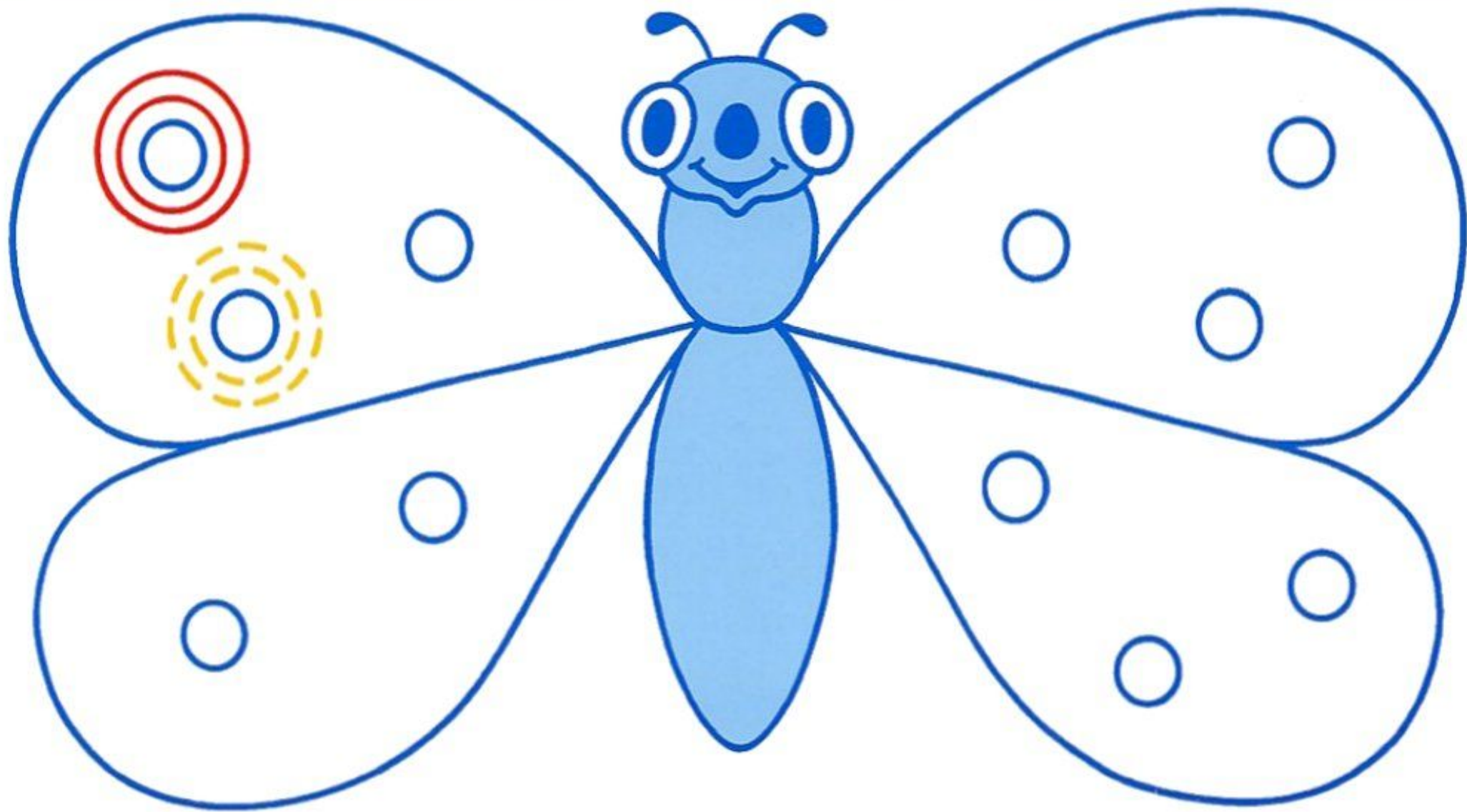

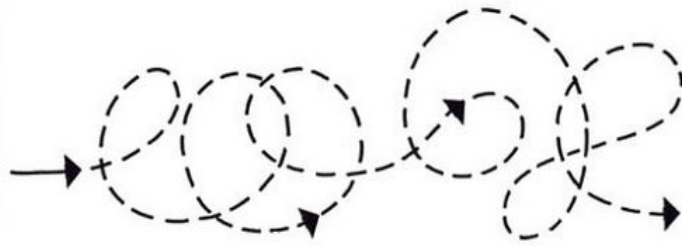
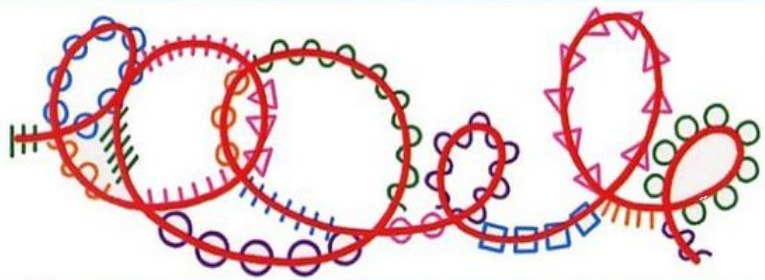

1

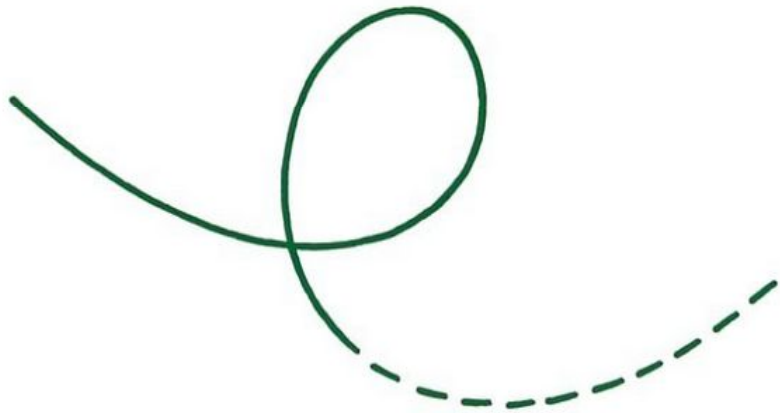

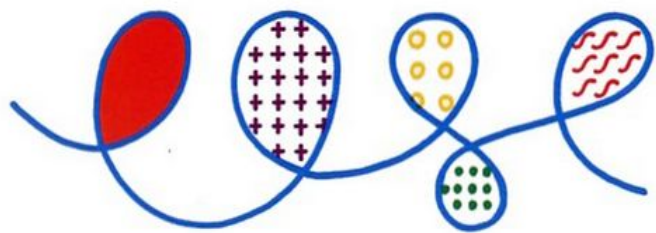

1

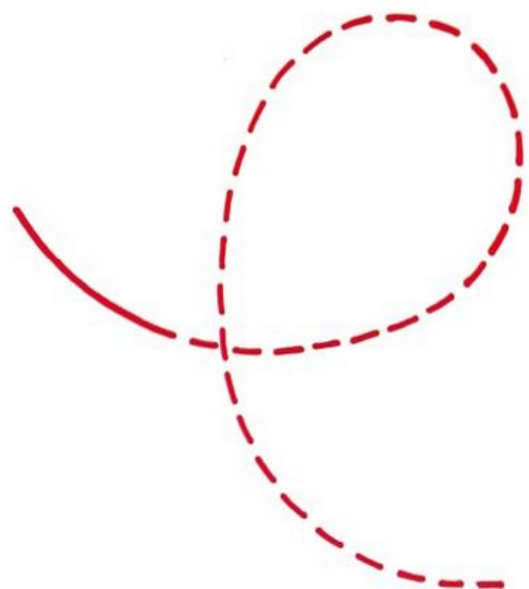

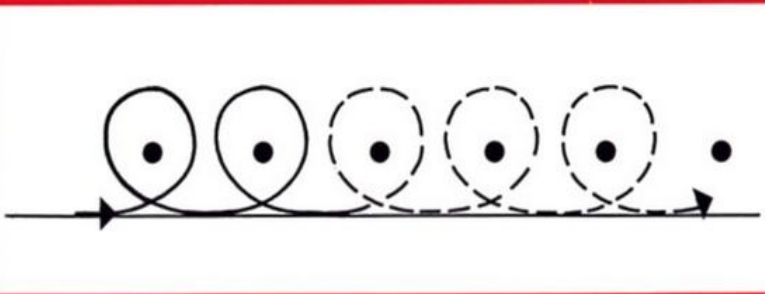
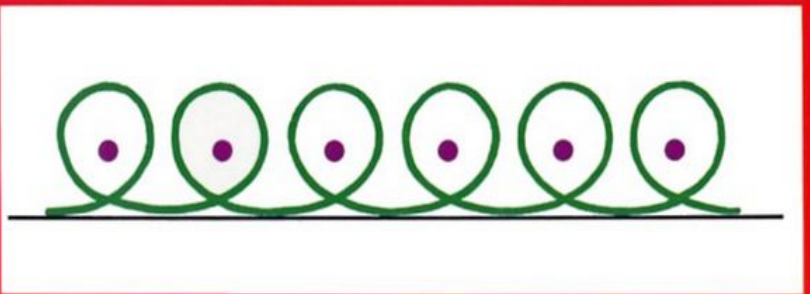

1

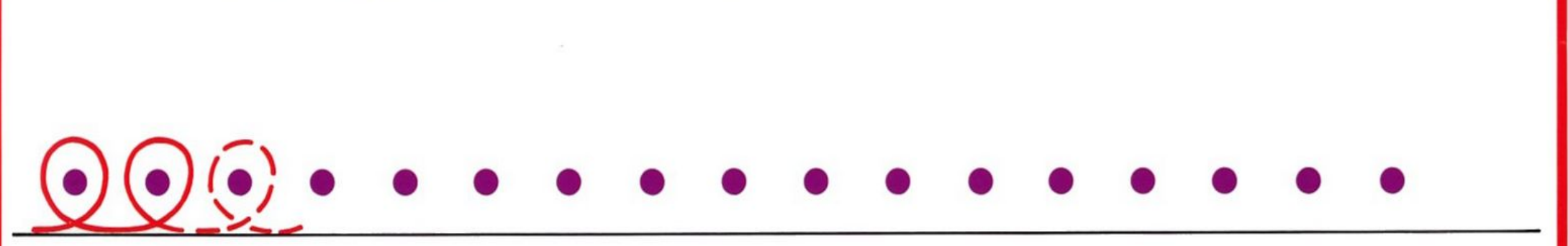
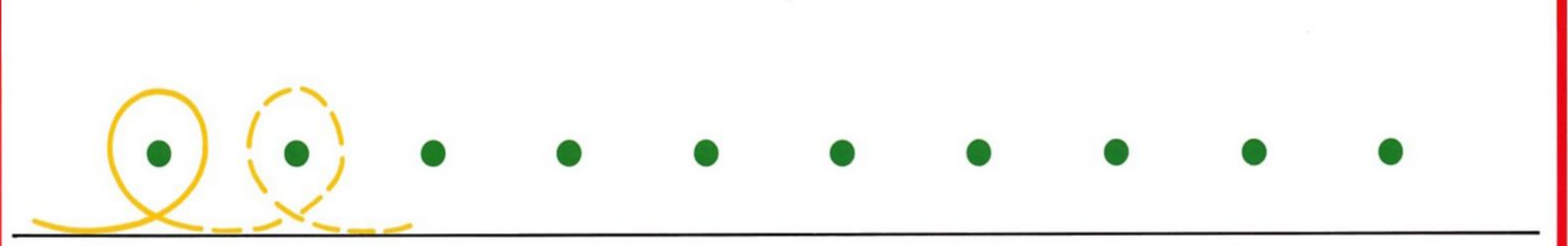
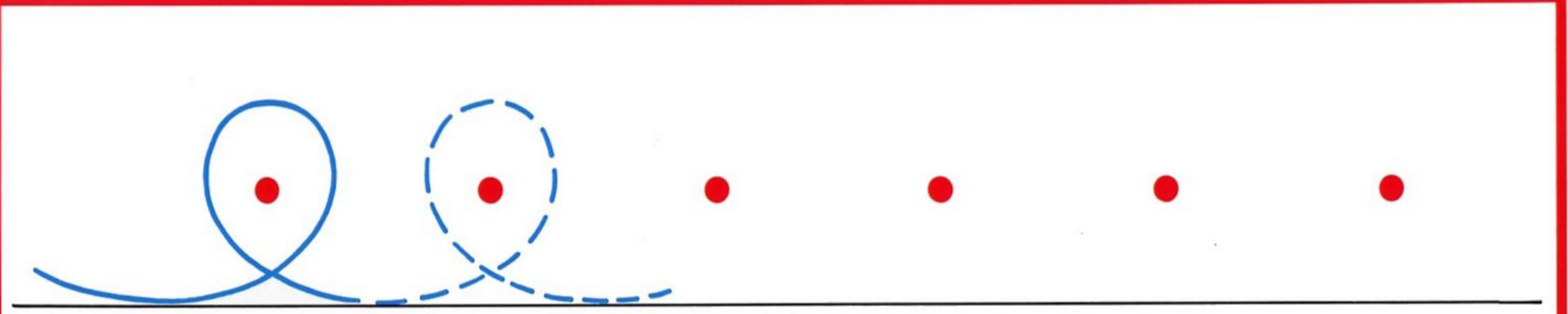

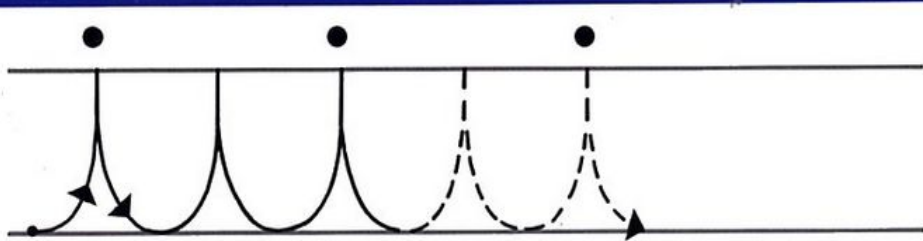
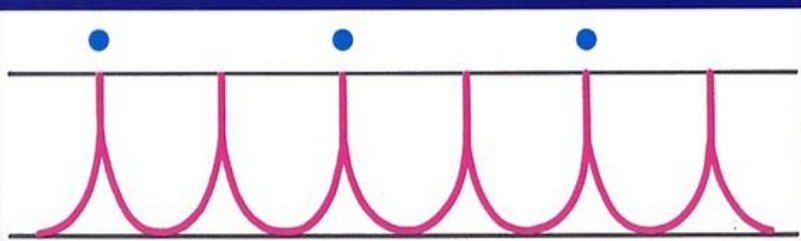

1

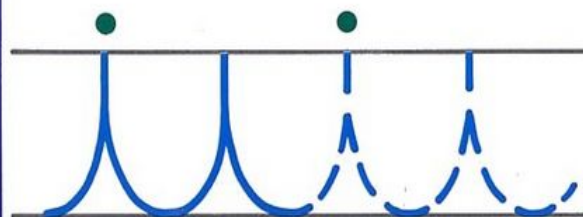
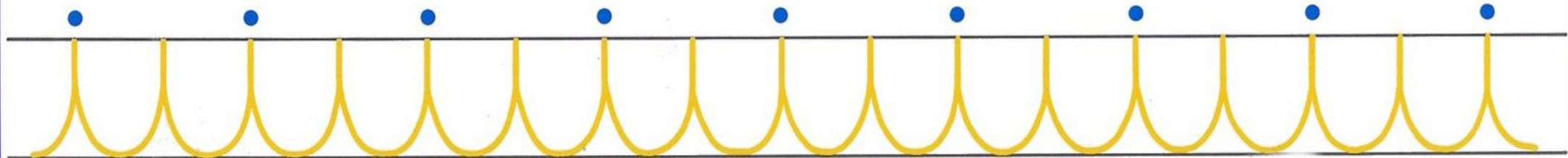

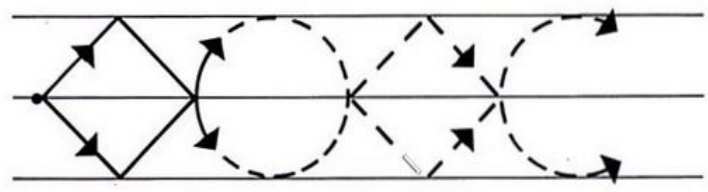
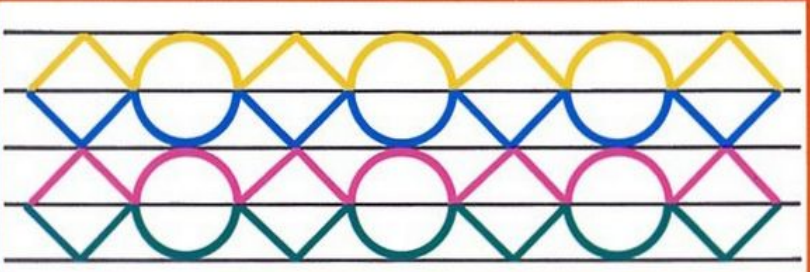

1

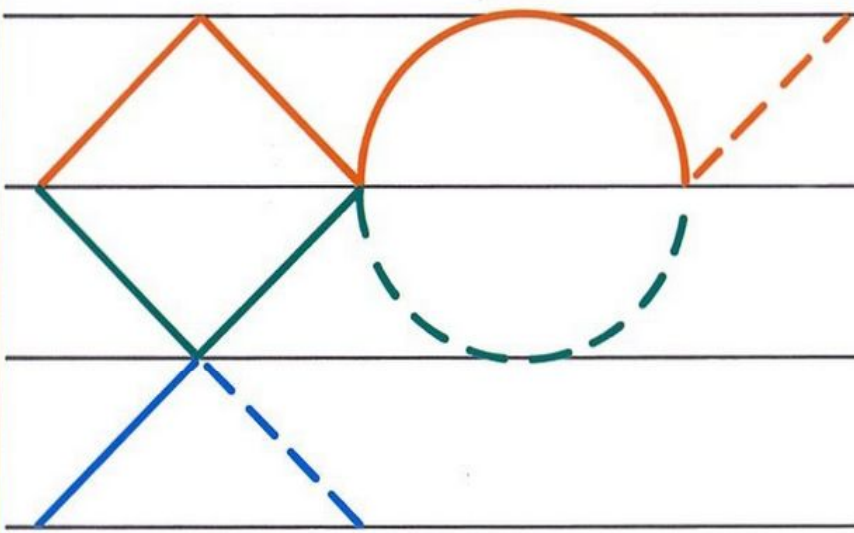

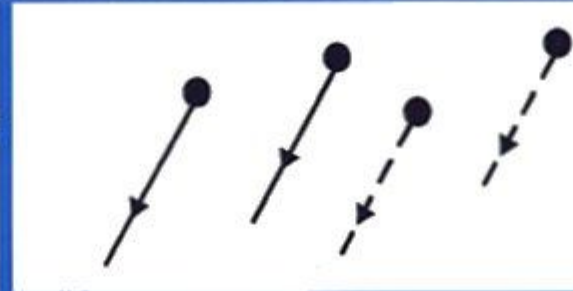

2





2

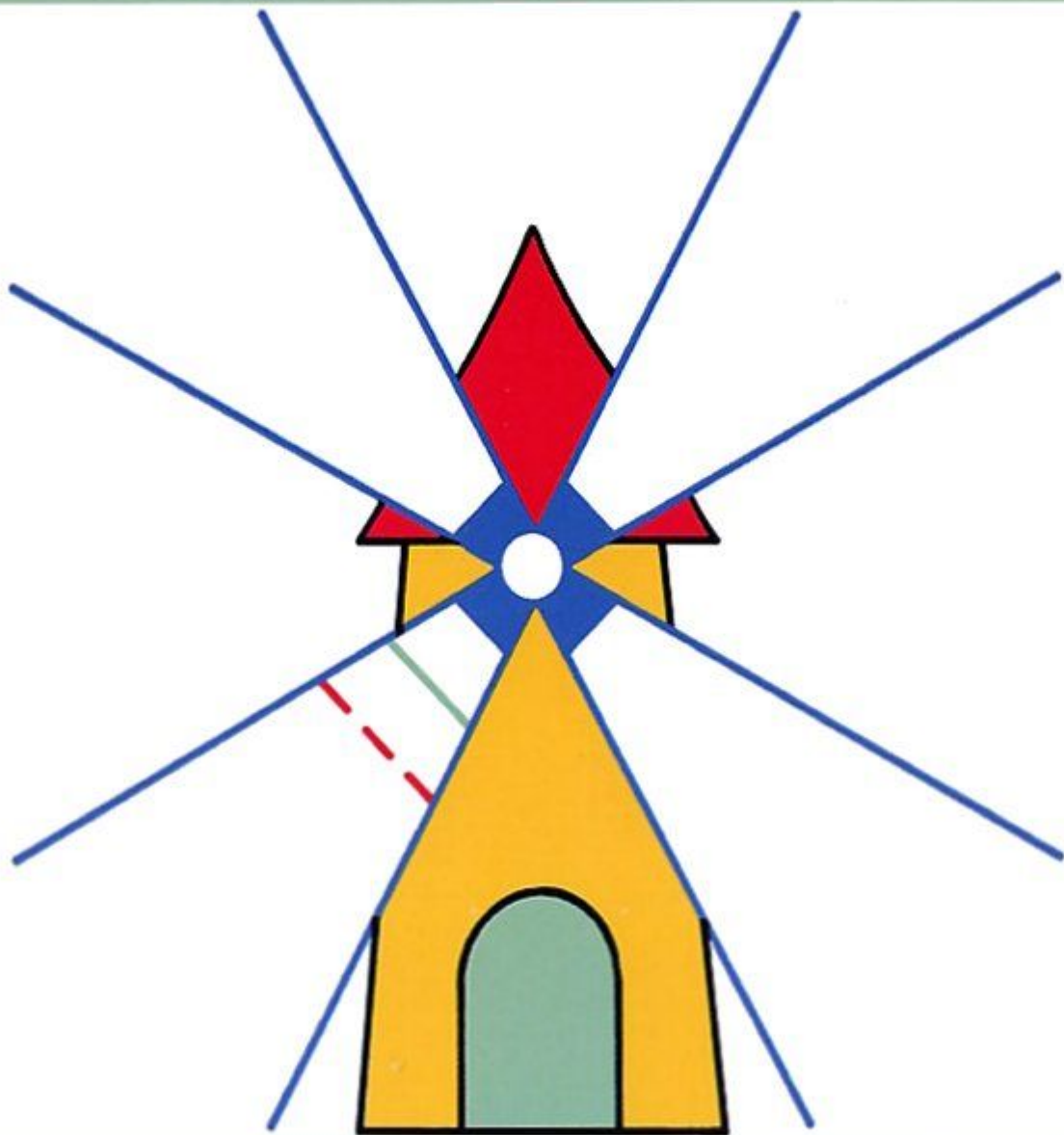

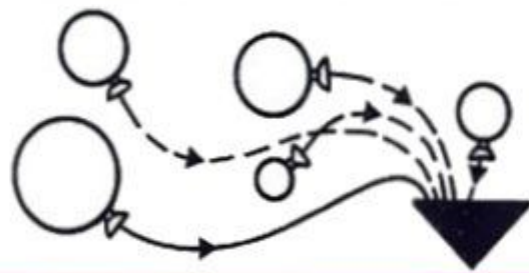

2

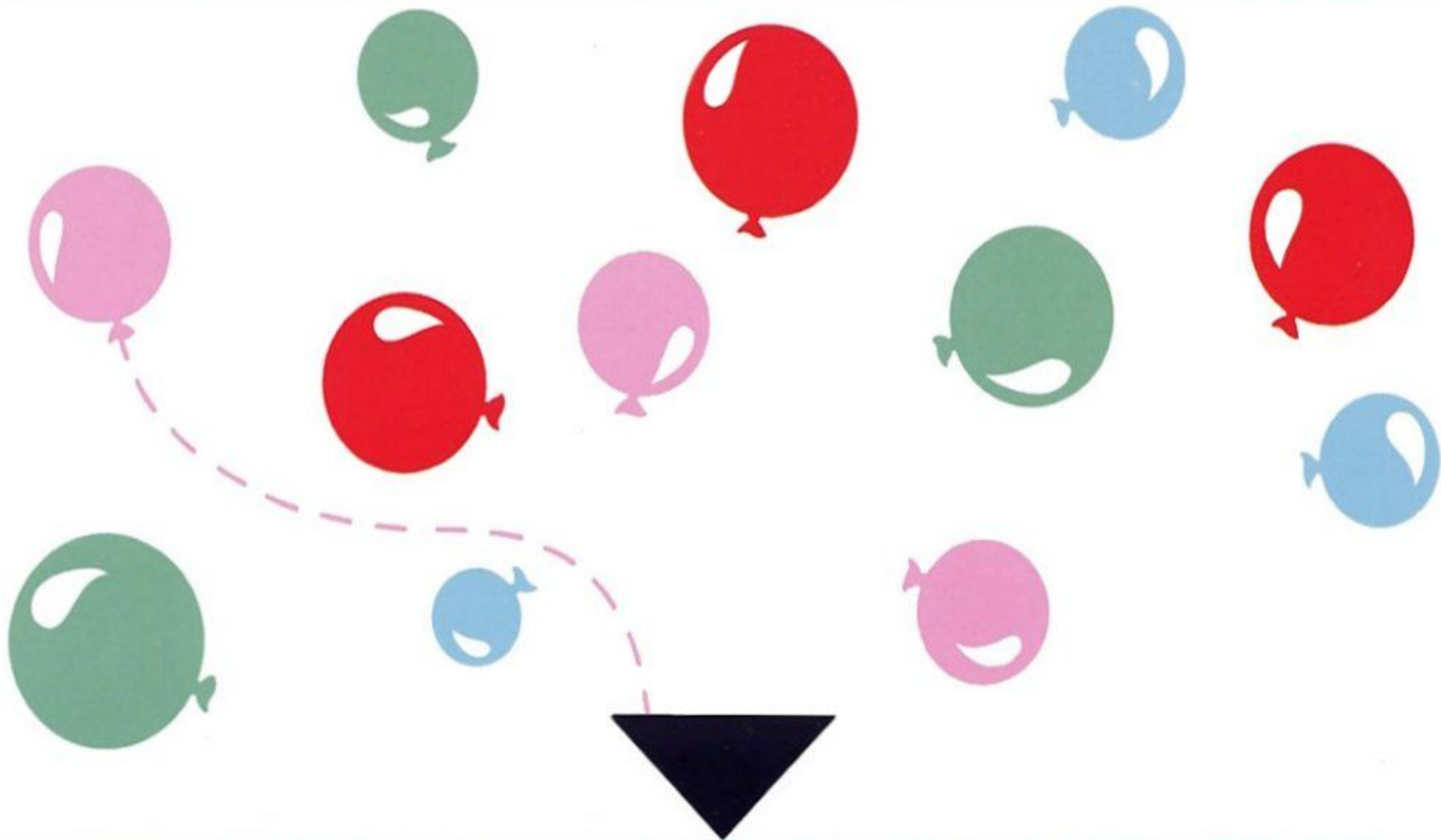

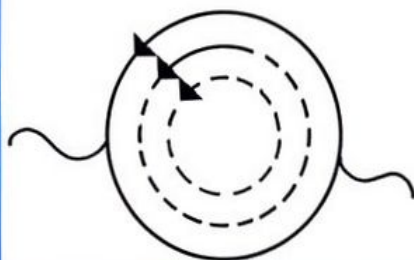
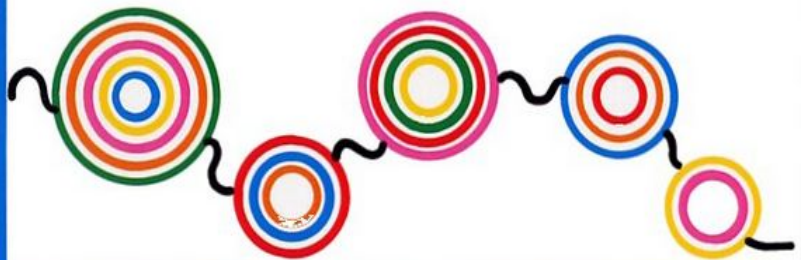

2

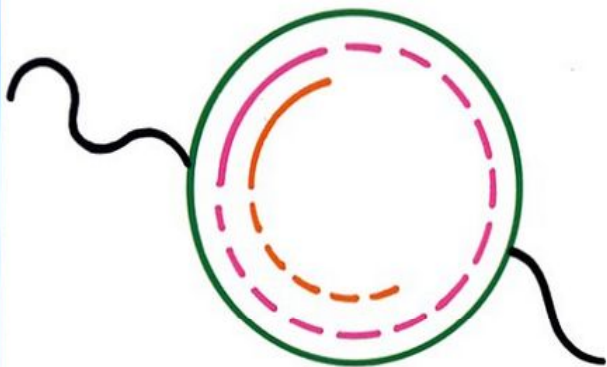

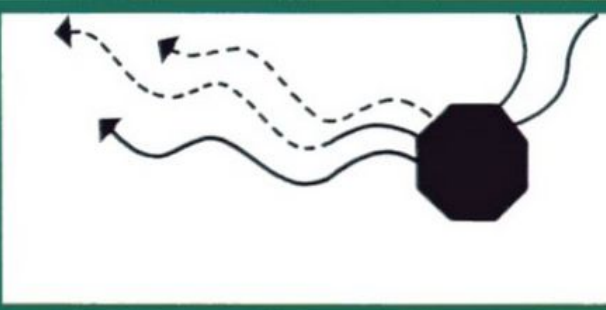
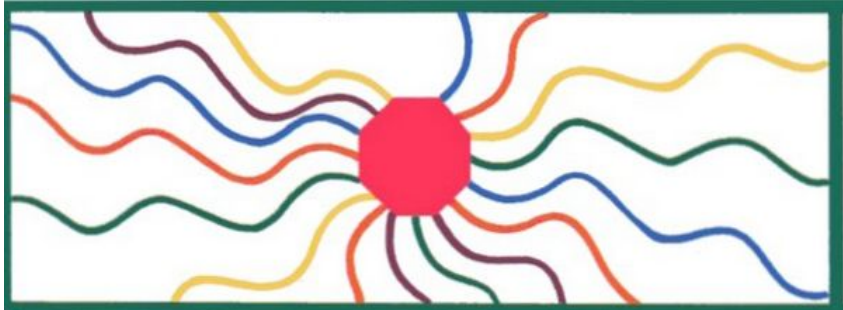

2

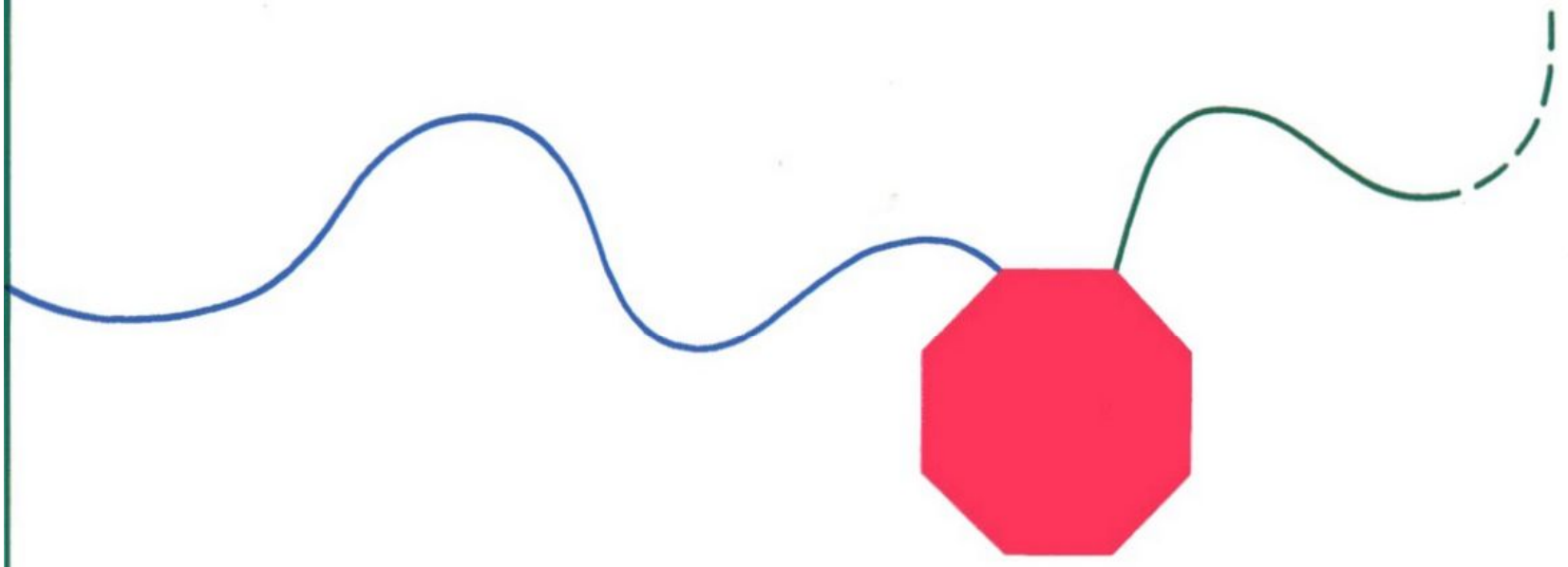

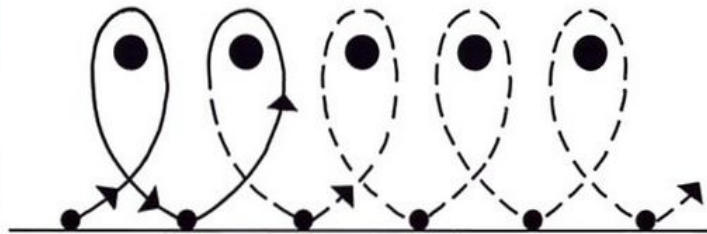
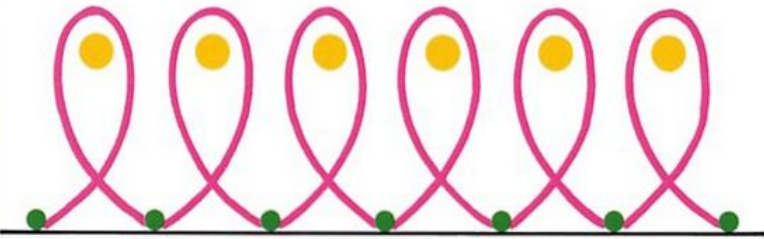

2

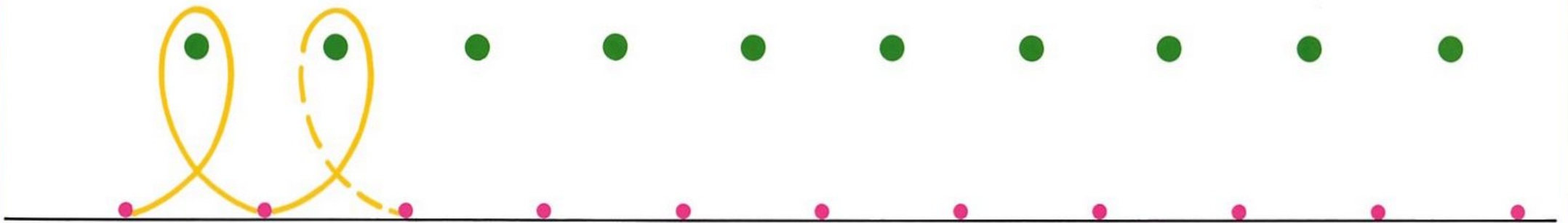
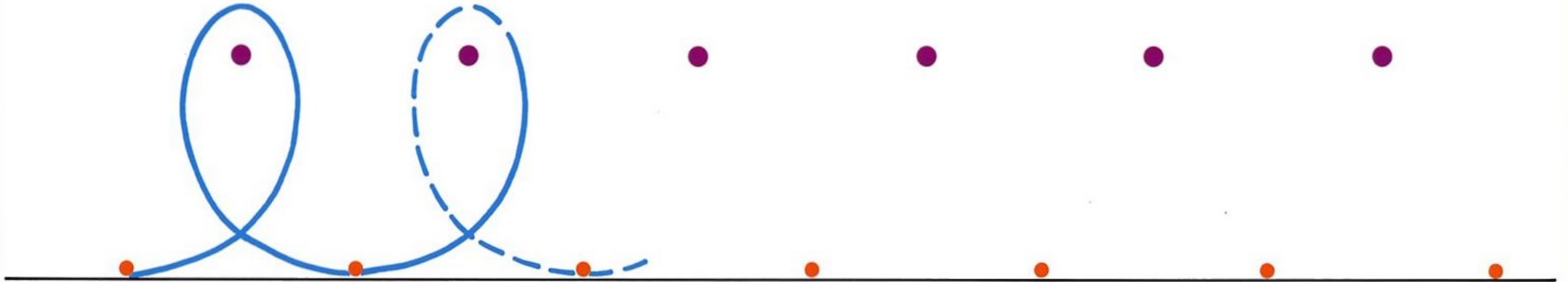

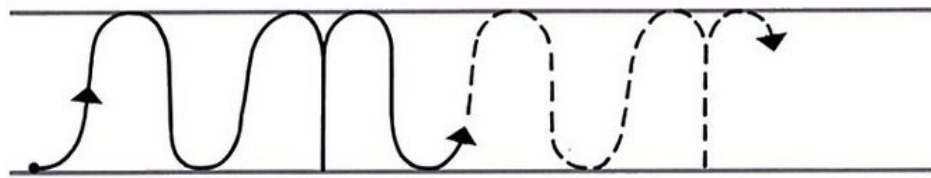
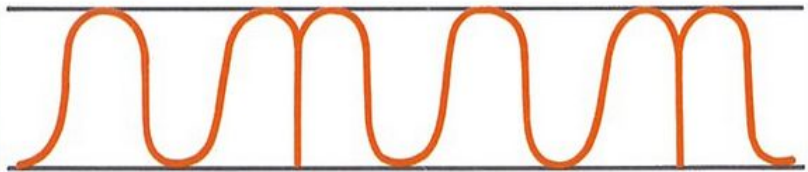

2

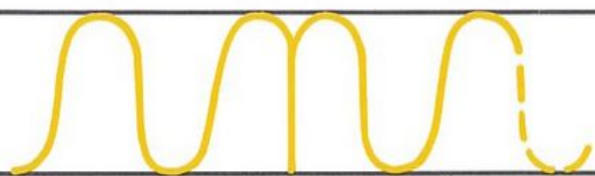

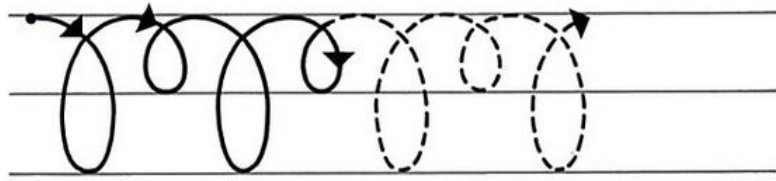
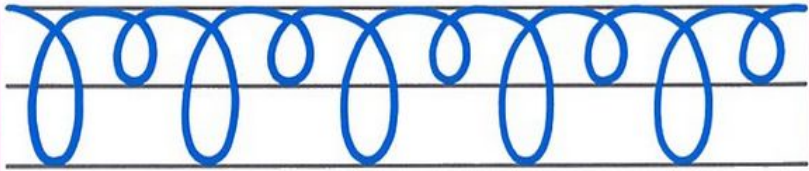

2

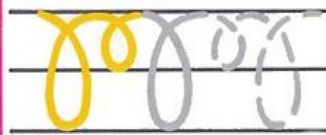
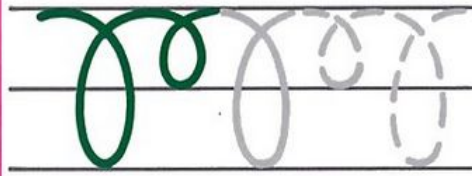
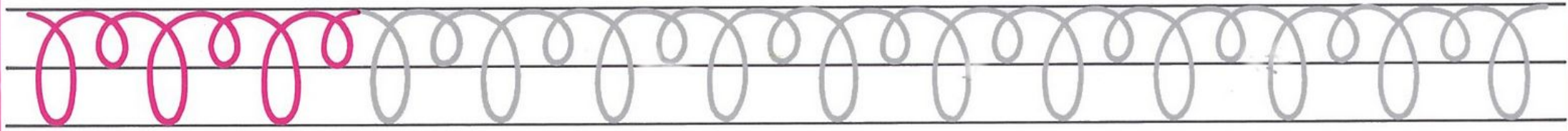

2

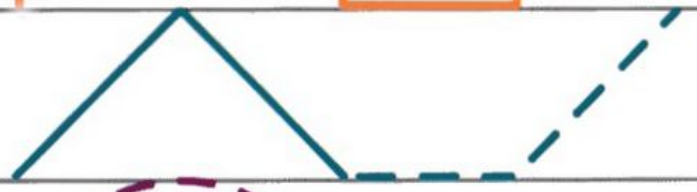
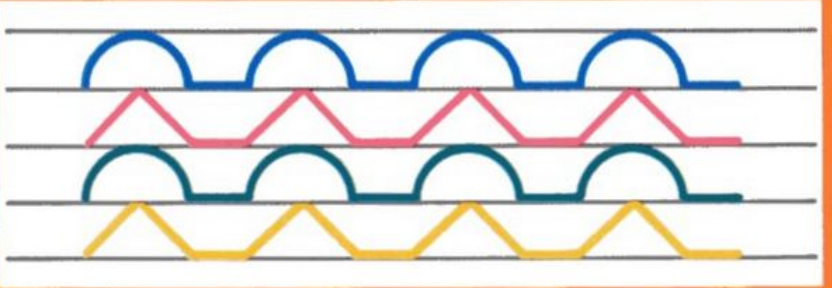
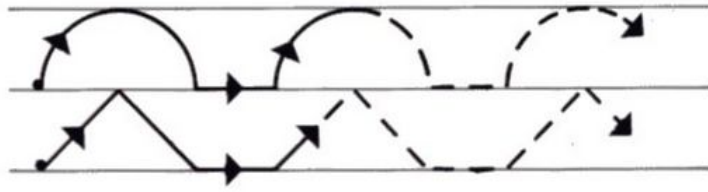

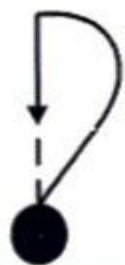

3

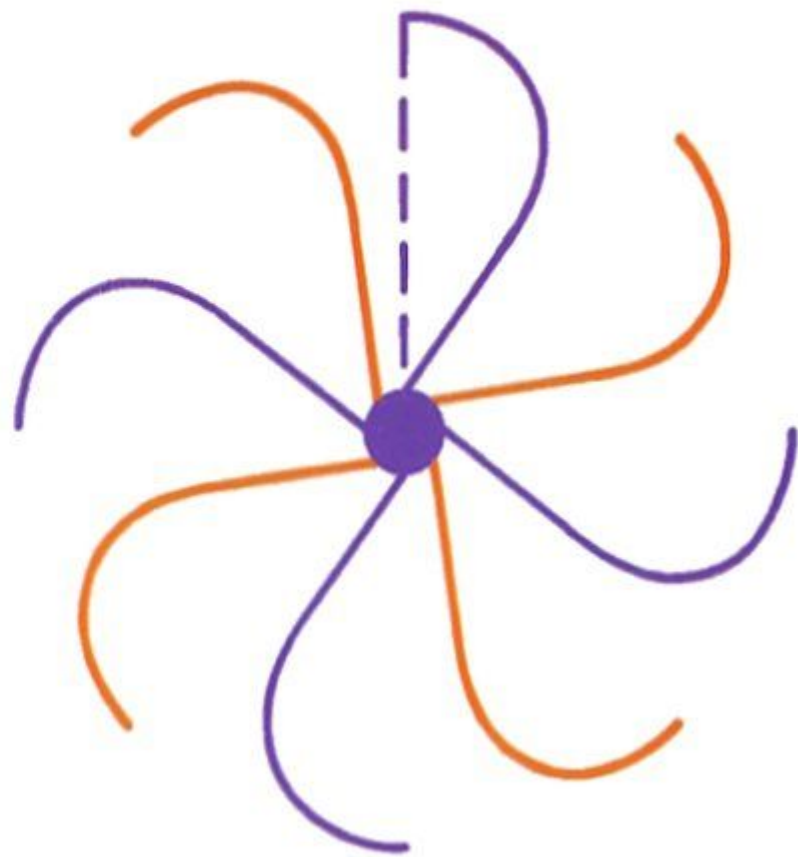
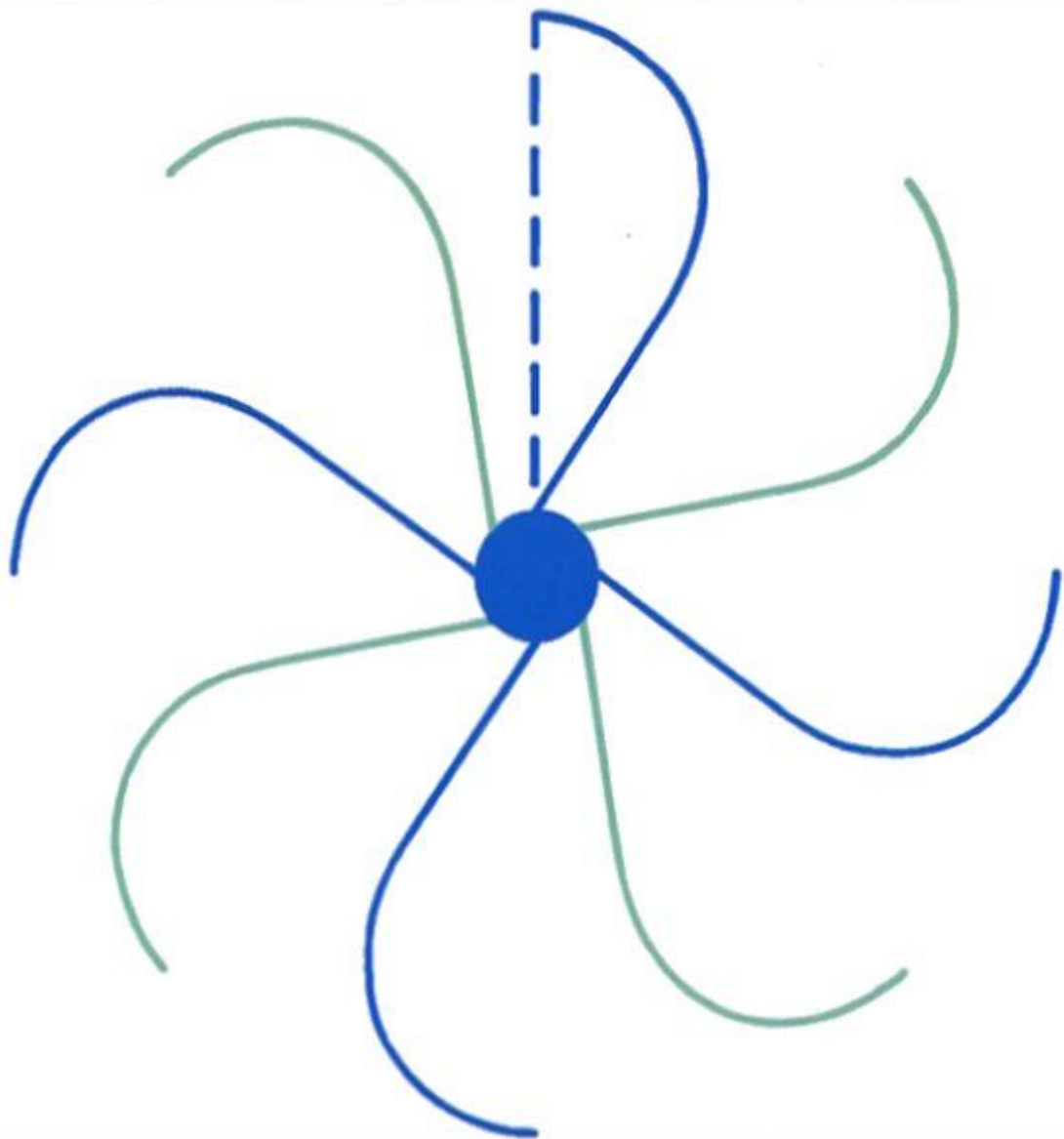



3

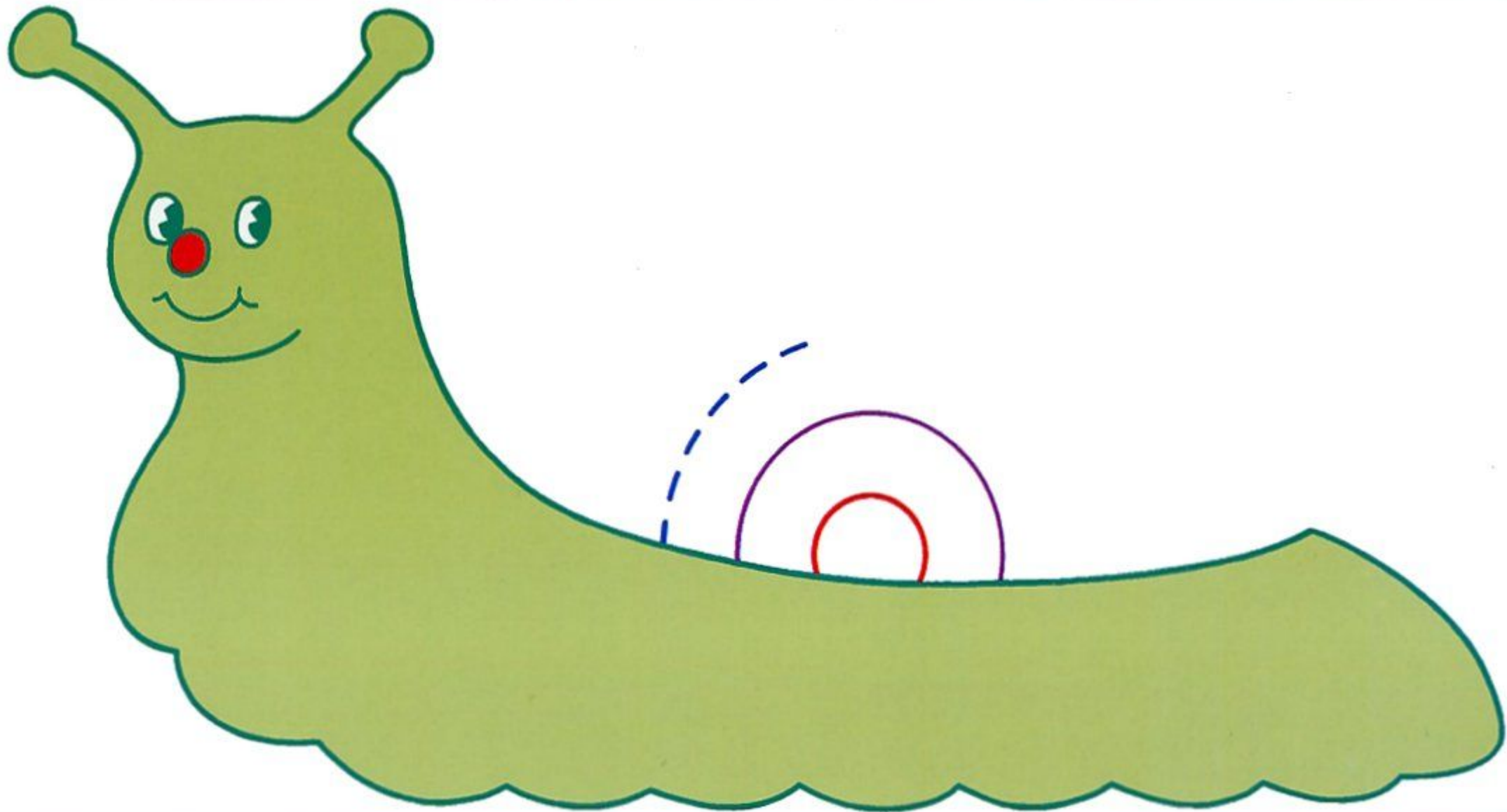



3

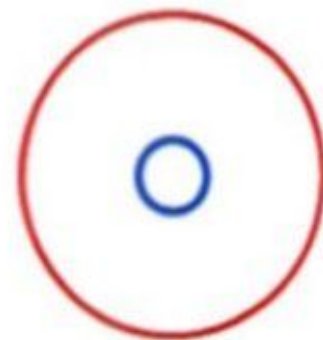
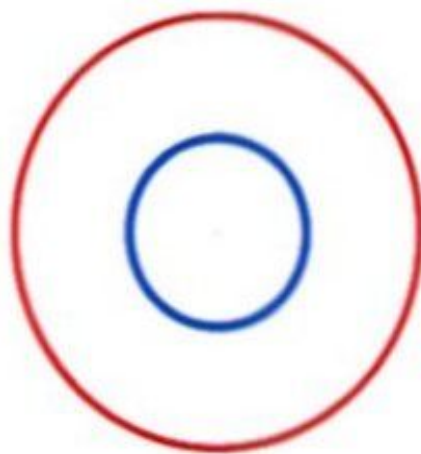
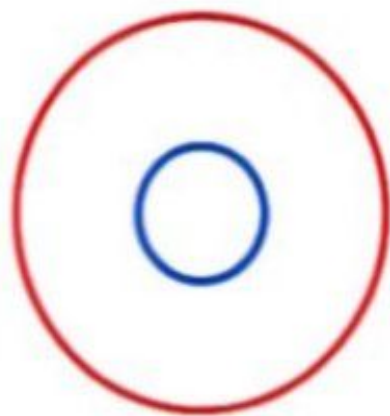
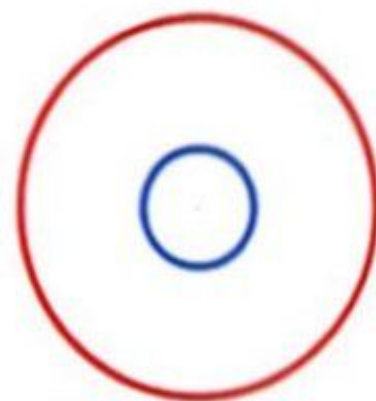
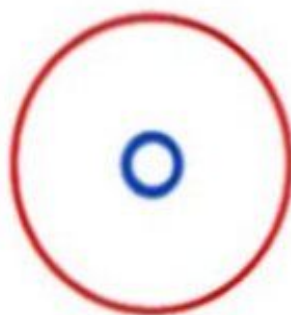

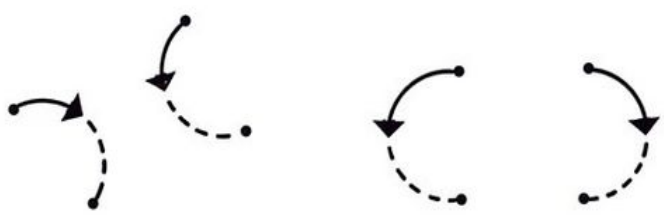
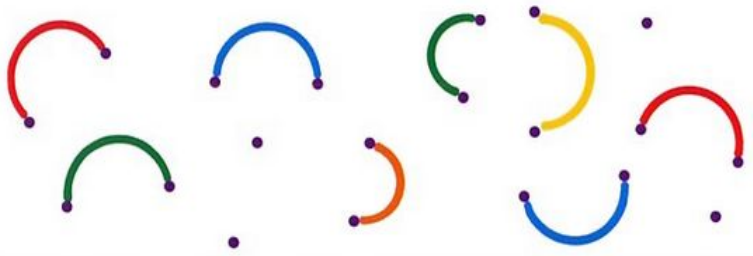

3

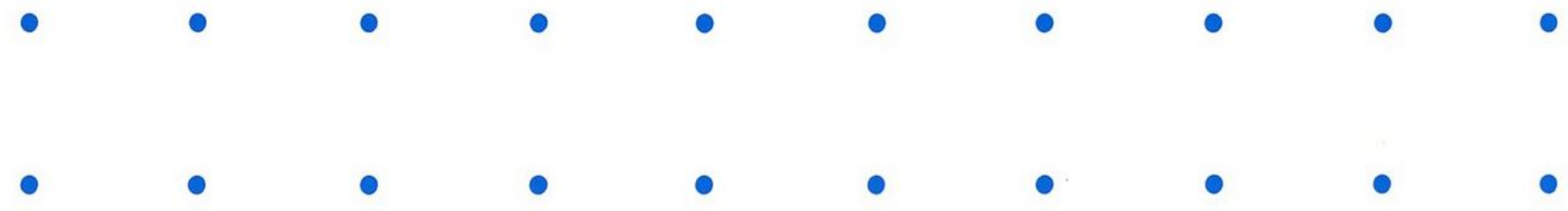
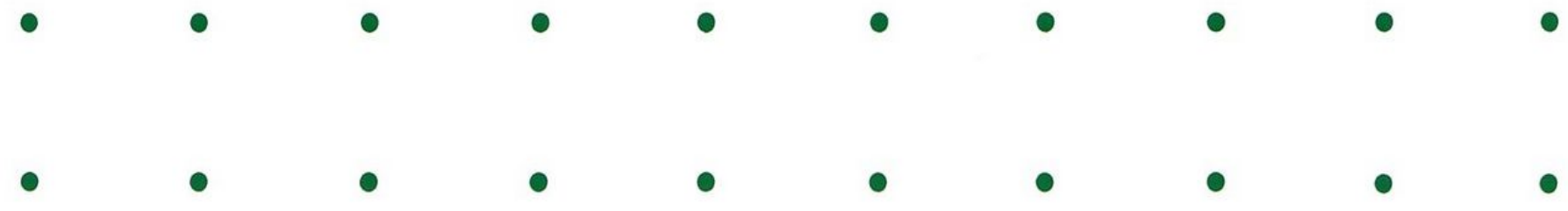
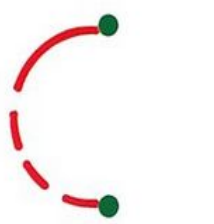
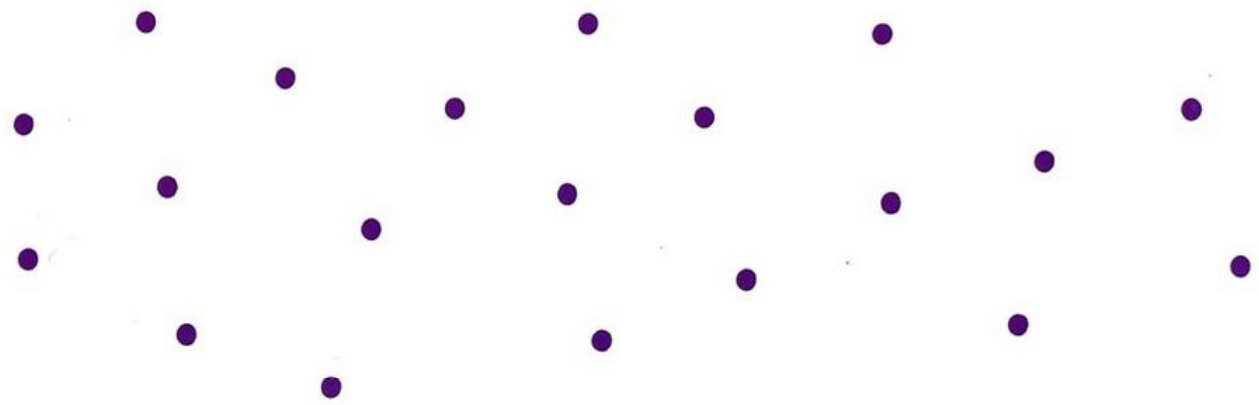

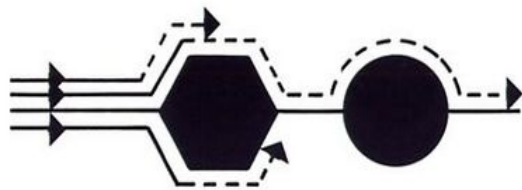

3

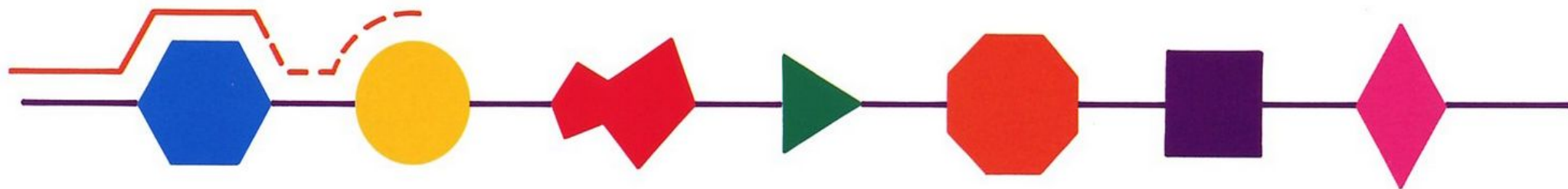

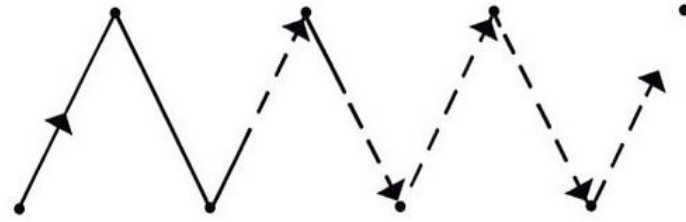

3

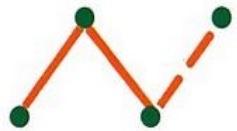
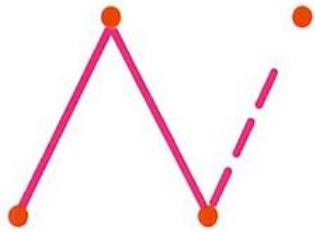
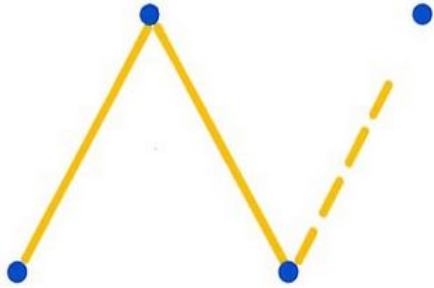

Handwriting practice row 1, left section: A continuous green cursive wave pattern on a two-line grid.

Handwriting practice row 1, right section: A continuous black cursive wave pattern on a two-line grid. The first two waves are solid with arrows indicating the direction of the stroke. The next two waves are dashed for tracing. The final wave is solid with an arrow at the end.

3

Handwriting practice row 2: A continuous pink cursive wave pattern on a two-line grid.

Handwriting practice row 3: A blue cursive wave pattern on a two-line grid. The first two waves are solid, and the next two waves are dashed for tracing.

Handwriting practice row 4: An orange cursive wave pattern on a two-line grid. The first two waves are solid, and the next two waves are dashed for tracing.

Handwriting practice row 5: A yellow cursive wave pattern on a two-line grid. The first two waves are solid, and the next two waves are dashed for tracing.

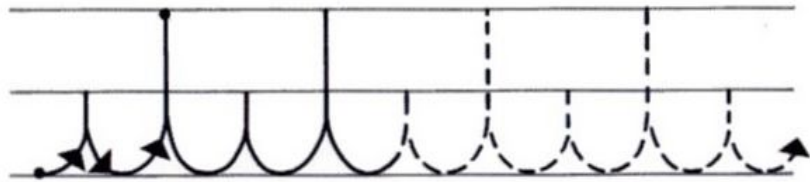
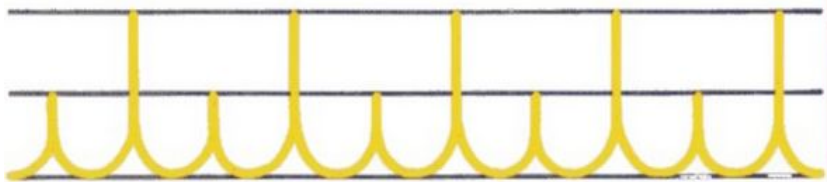

3

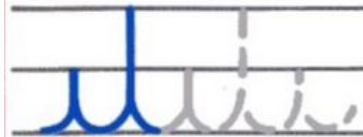
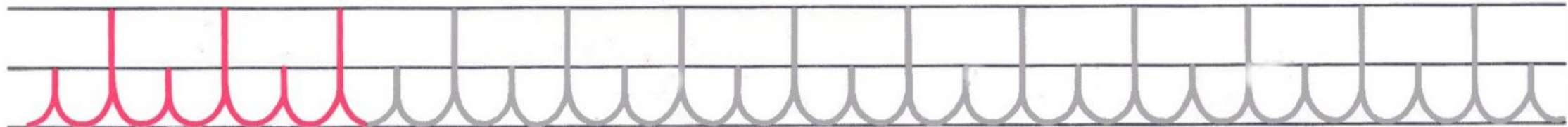



4

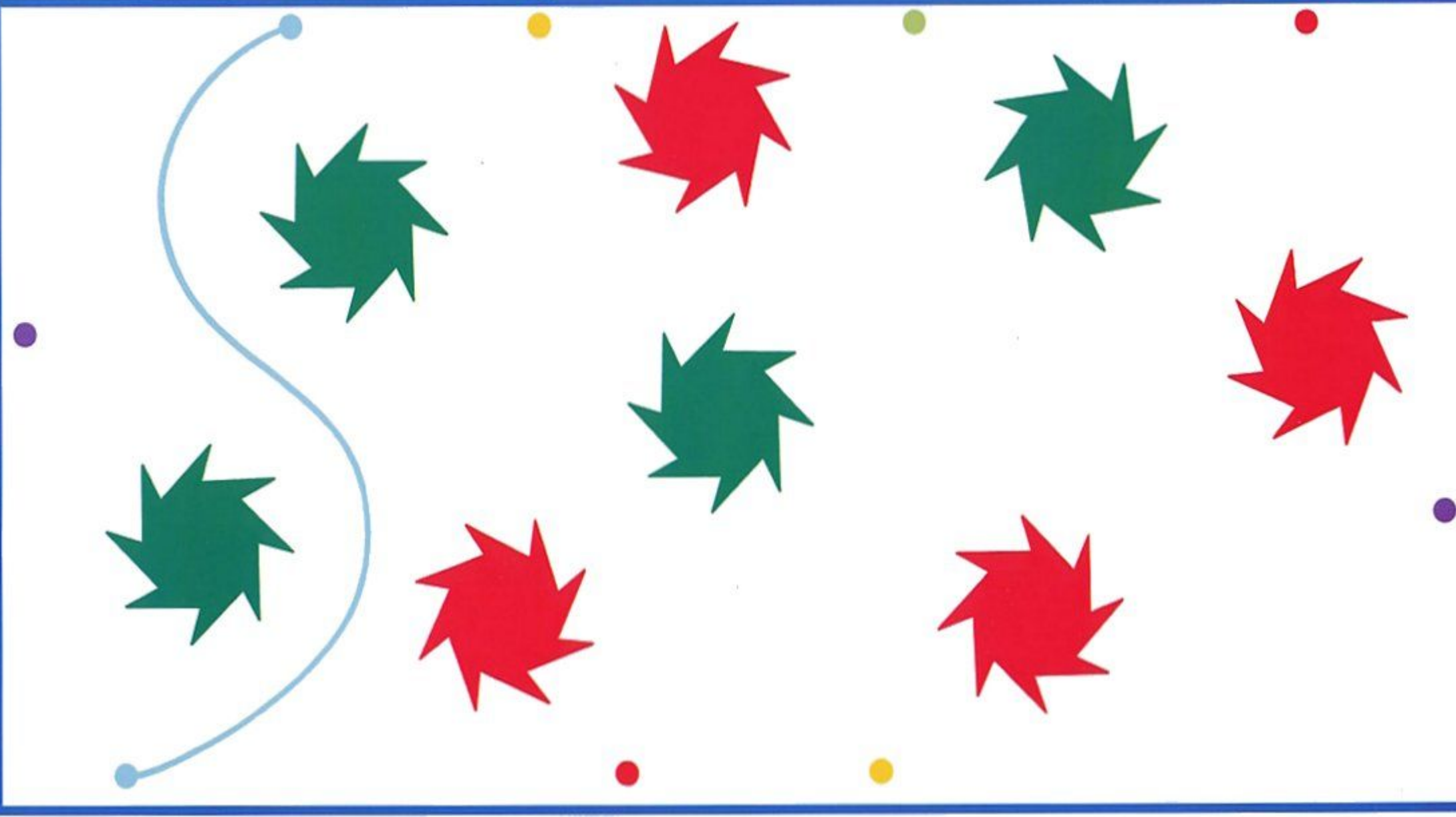

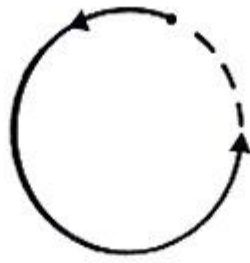
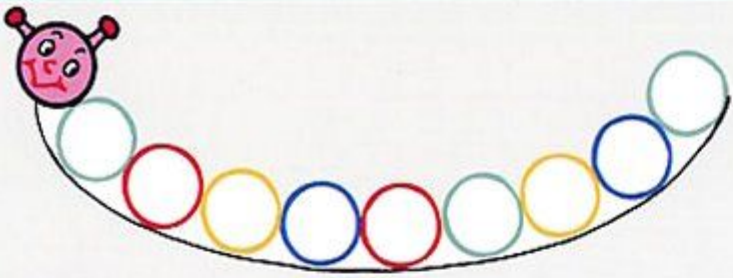

4

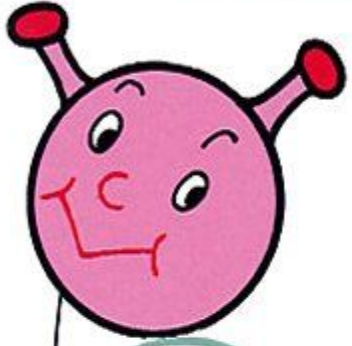

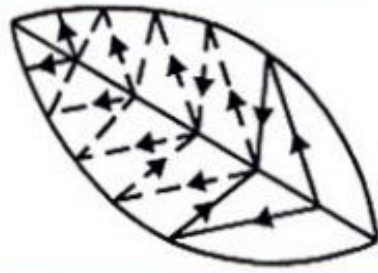

4

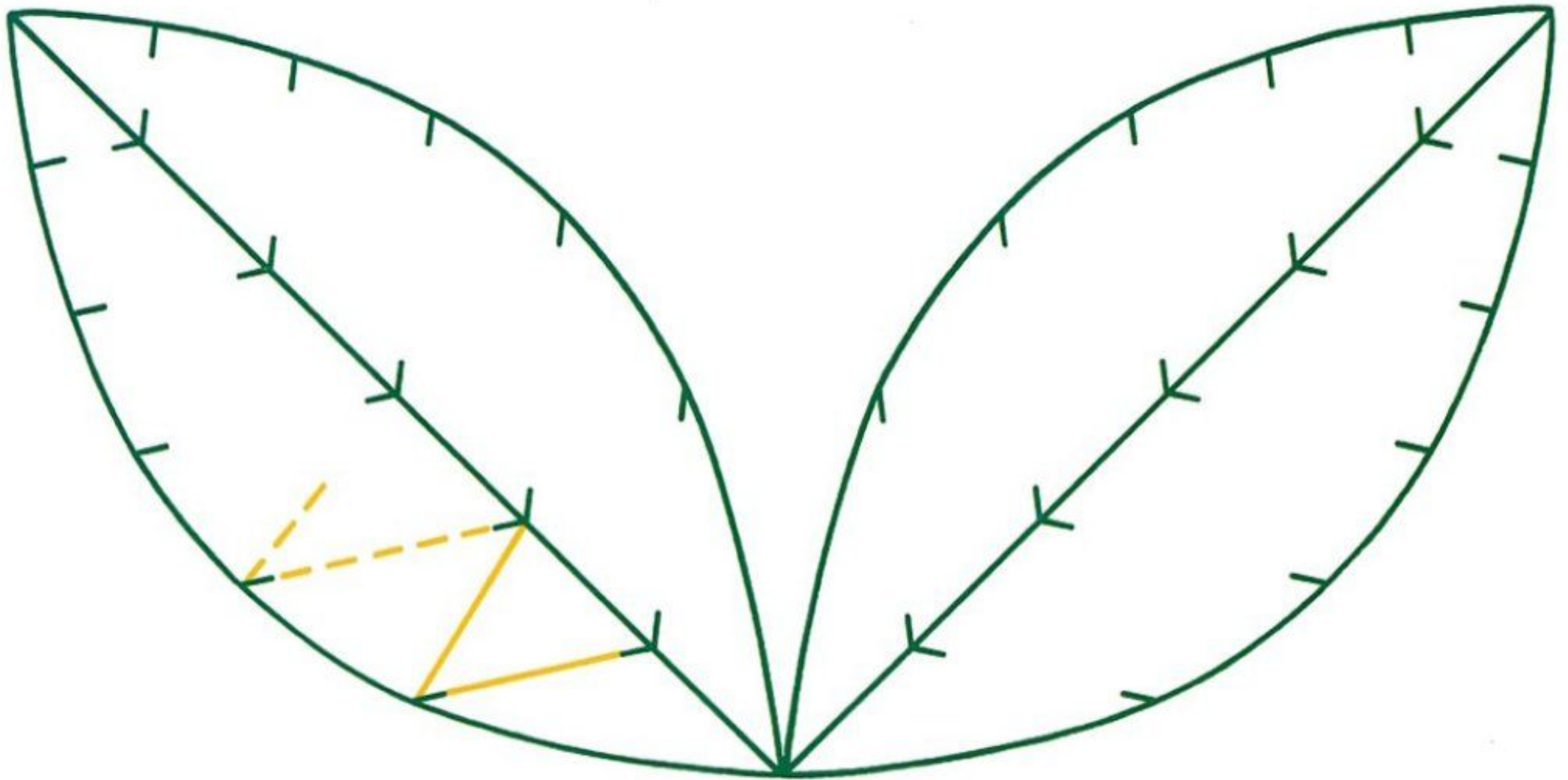

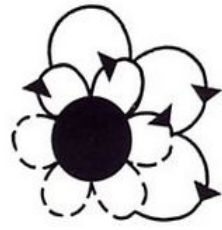

4

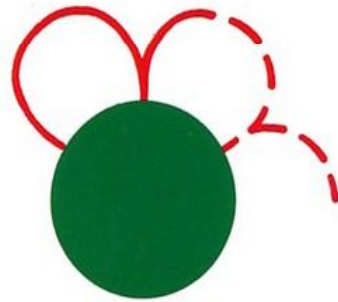

4

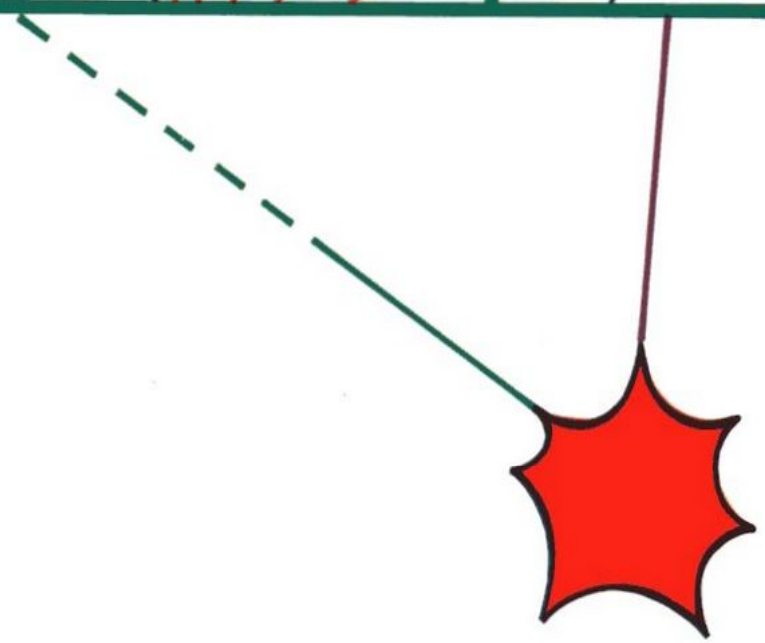

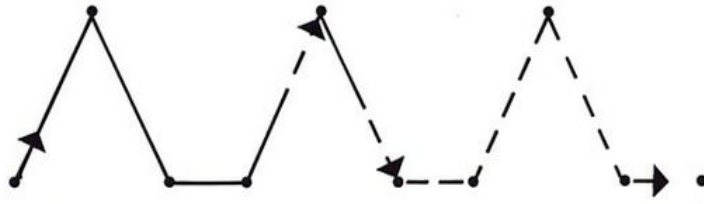

4

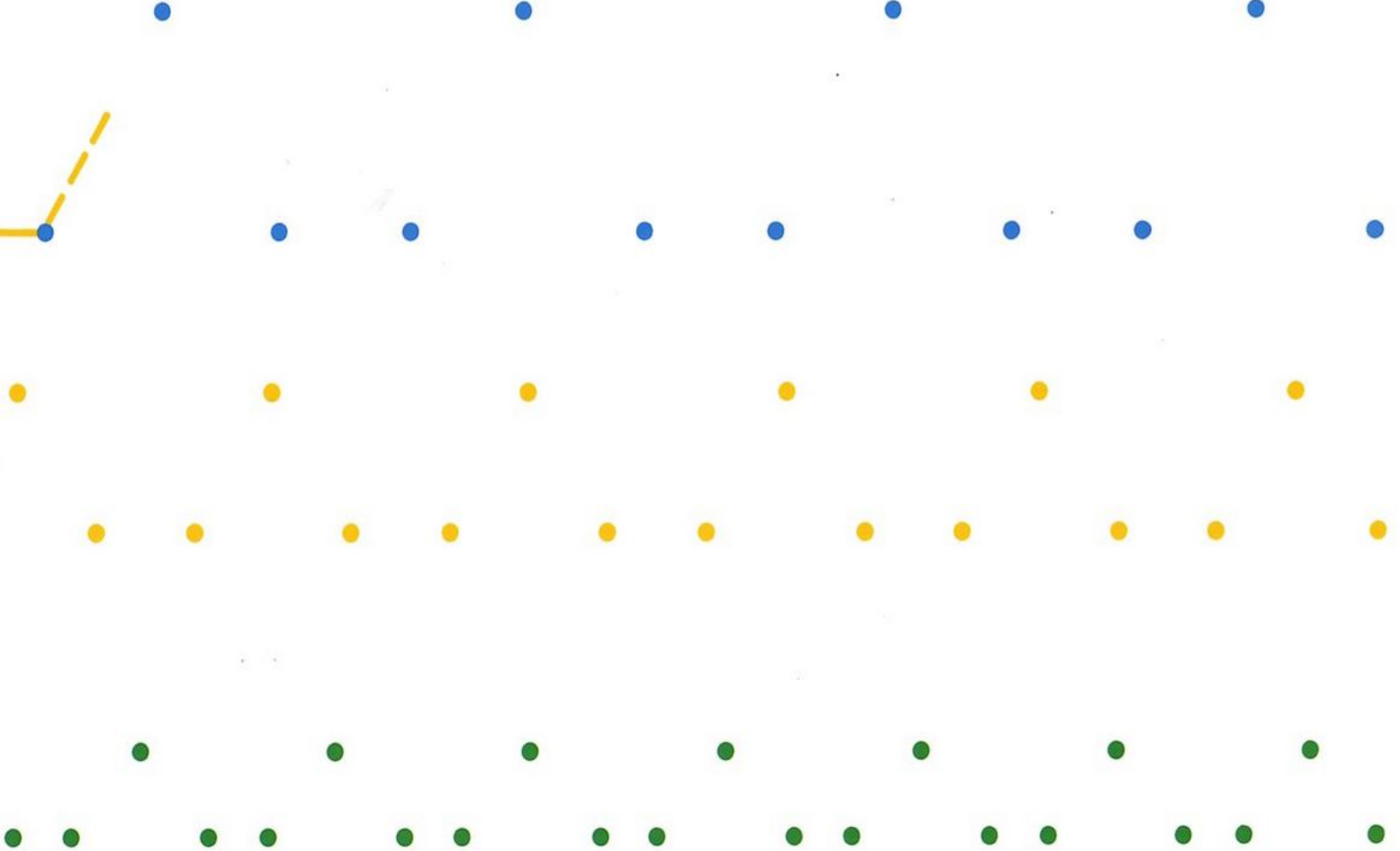
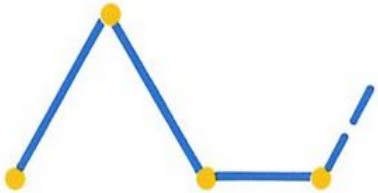
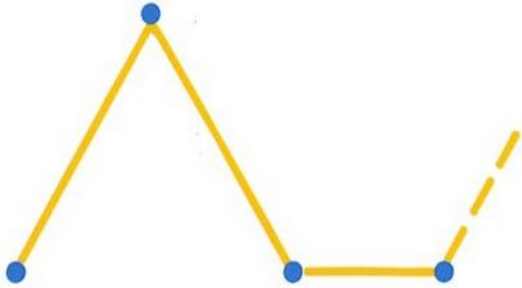

Handwriting practice row 1, left section: A continuous yellow cursive wave pattern on a four-line grid.

Handwriting practice row 1, right section: A continuous black cursive wave pattern on a four-line grid. The first two waves are solid with arrows indicating the direction of the stroke. The last two waves are dashed for tracing.

4

Handwriting practice row 2: A continuous red cursive wave pattern on a four-line grid.

Handwriting practice row 3: A purple cursive wave pattern on a four-line grid. The first two waves are solid, and the last two are dashed for tracing.

Handwriting practice row 4: An orange cursive wave pattern on a four-line grid. The first two waves are solid, and the last two are dashed for tracing.

Handwriting practice row 5: A pink cursive wave pattern on a four-line grid. The first two waves are solid, and the last two are dashed for tracing.

Handwriting practice row 1, left section: A continuous cursive line of connected loops on a four-line grid, colored pink.

Handwriting practice row 1, right section: A continuous cursive line of connected loops on a four-line grid. The first two loops are solid black with arrows indicating the direction of the pen stroke. The next two loops are dashed black for tracing.

4

Handwriting practice row 2: A continuous cursive line of connected loops on a four-line grid. The first three loops are solid green, and the remaining loops are light gray for tracing.

Handwriting practice row 3: A continuous cursive line of connected loops on a four-line grid. The first two loops are solid orange, and the next two are light gray for tracing.

Handwriting practice row 4: A continuous cursive line of connected loops on a four-line grid. The first two loops are solid blue, and the next two are light gray for tracing.



5

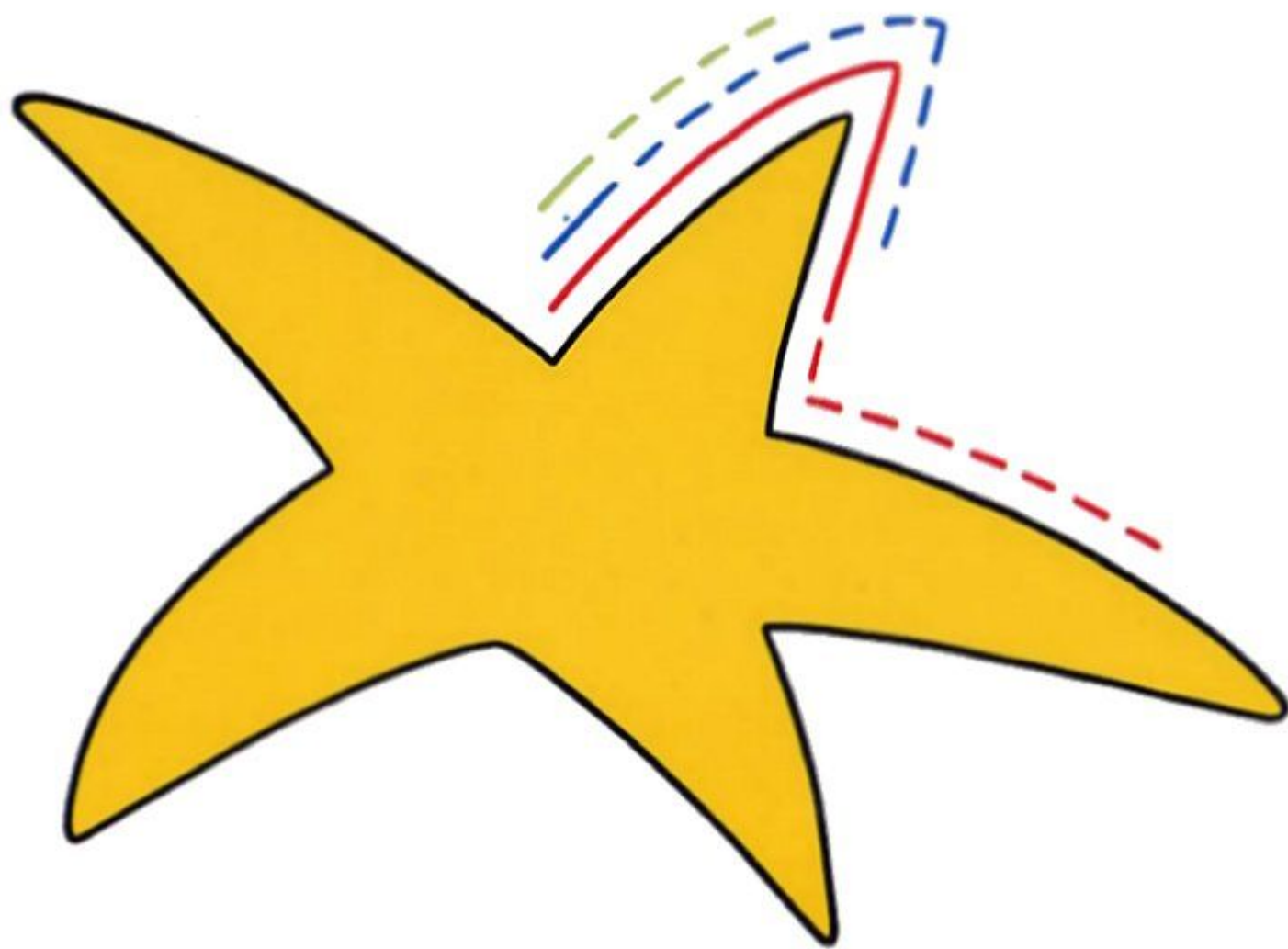

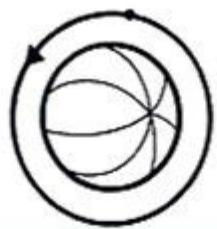

5



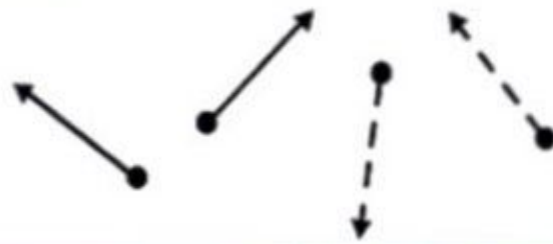
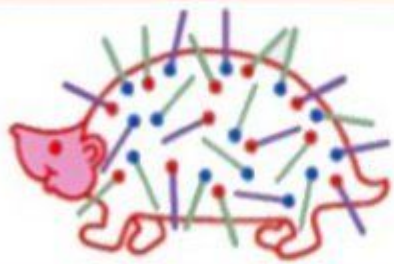

5

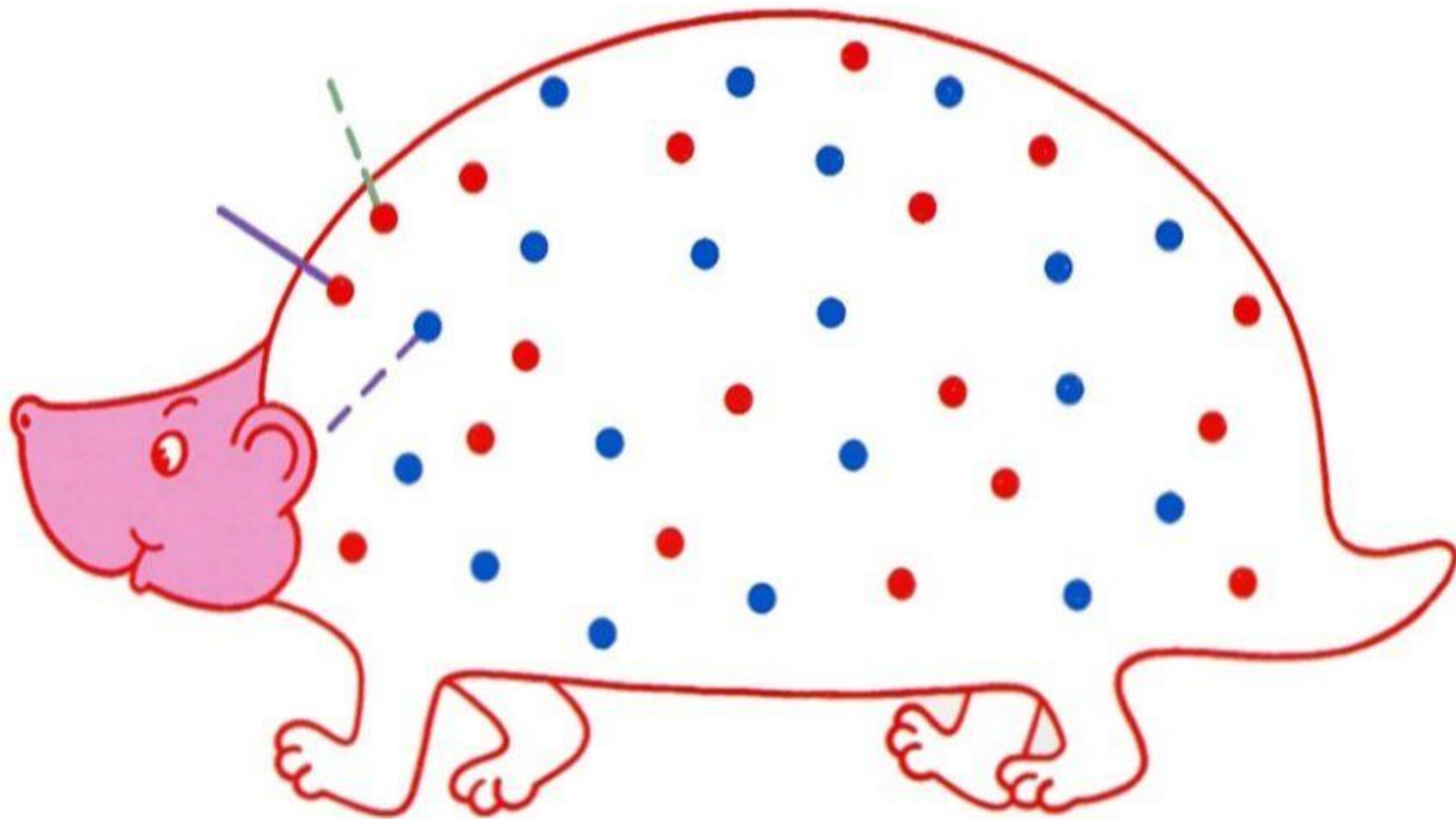

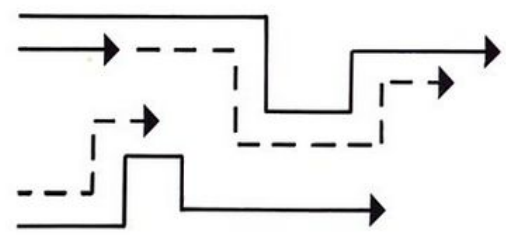
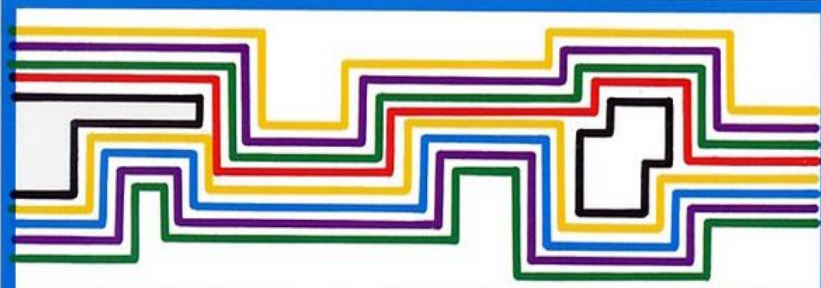

5

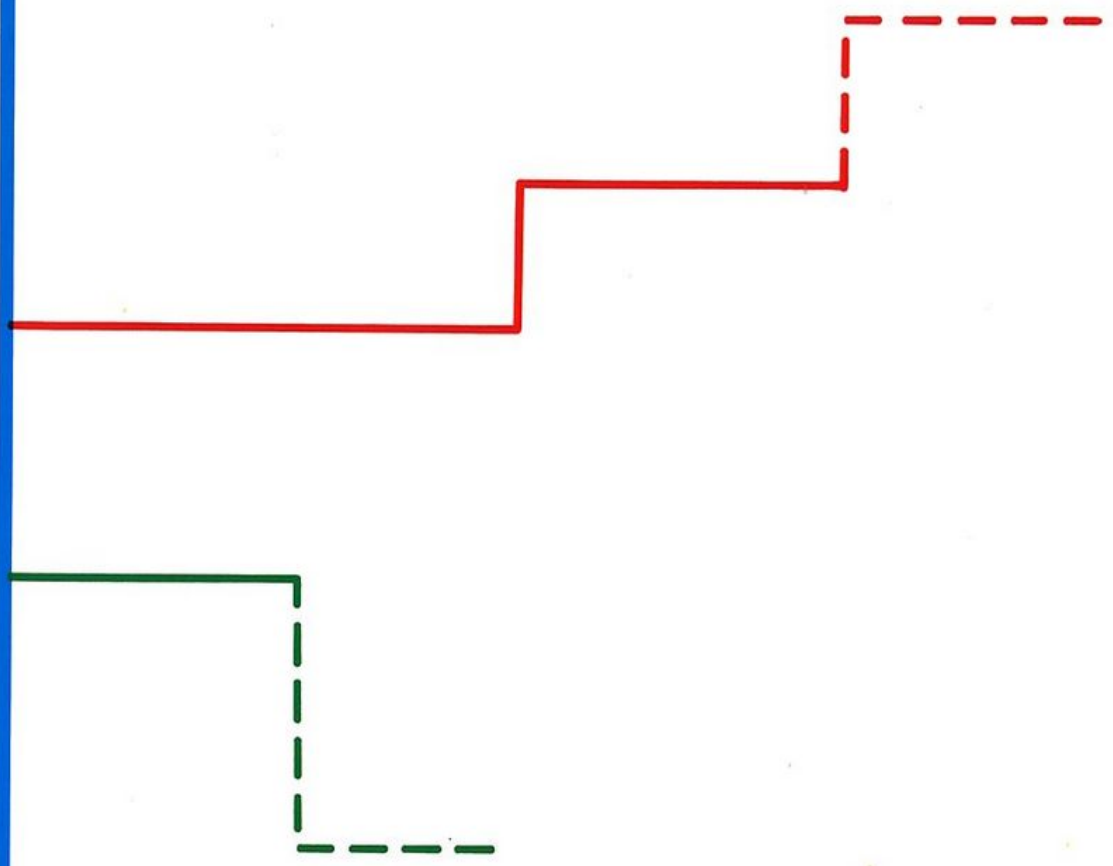



5

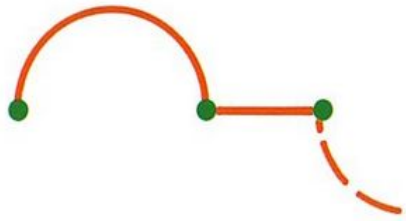
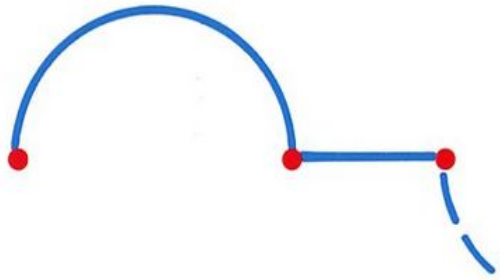

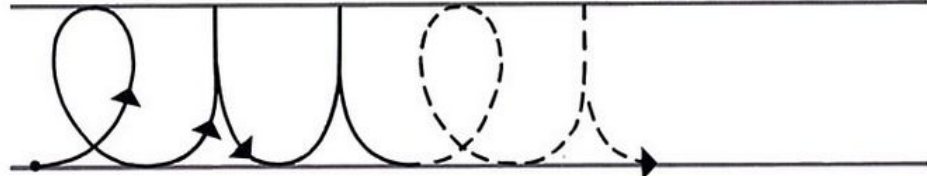

5

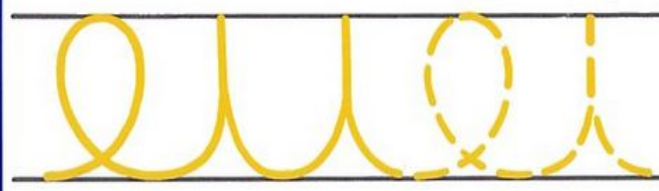
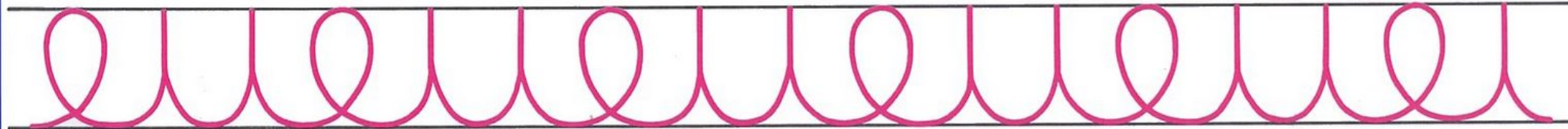

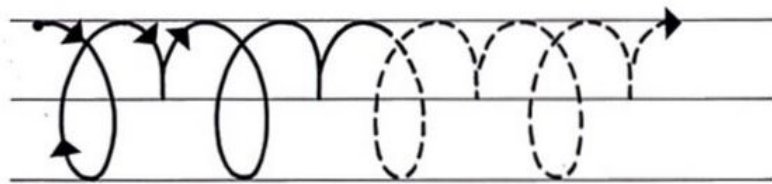
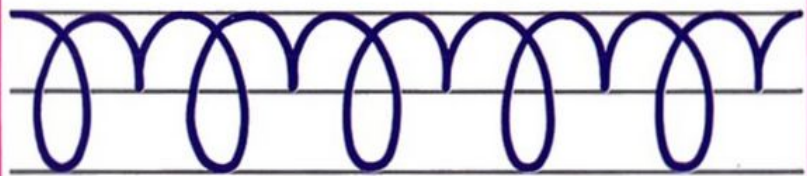

5

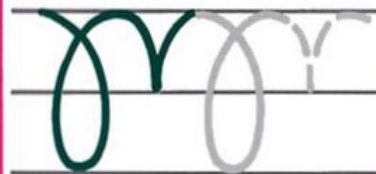
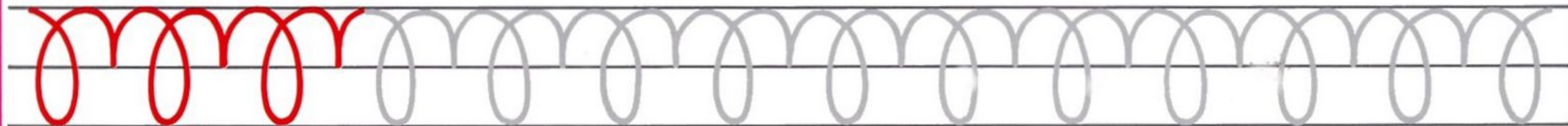

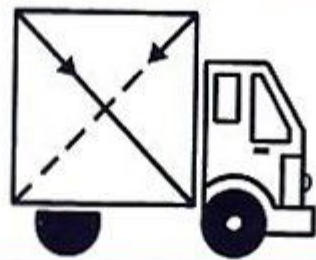

6

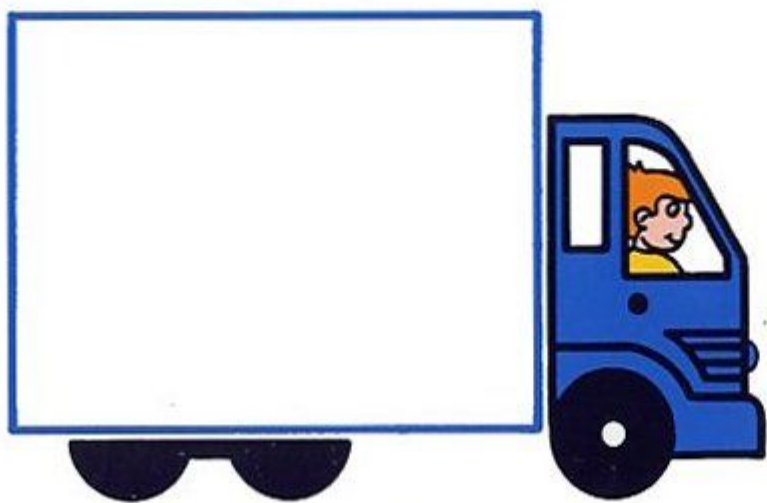
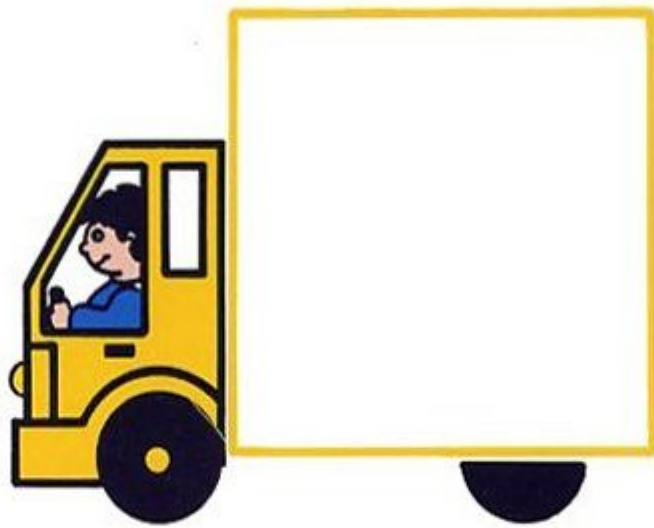

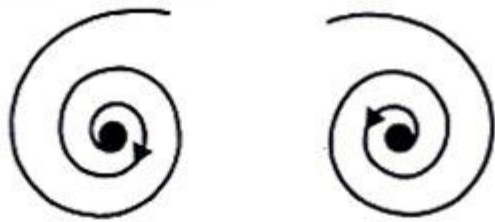

6



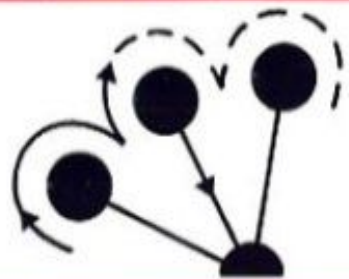

6

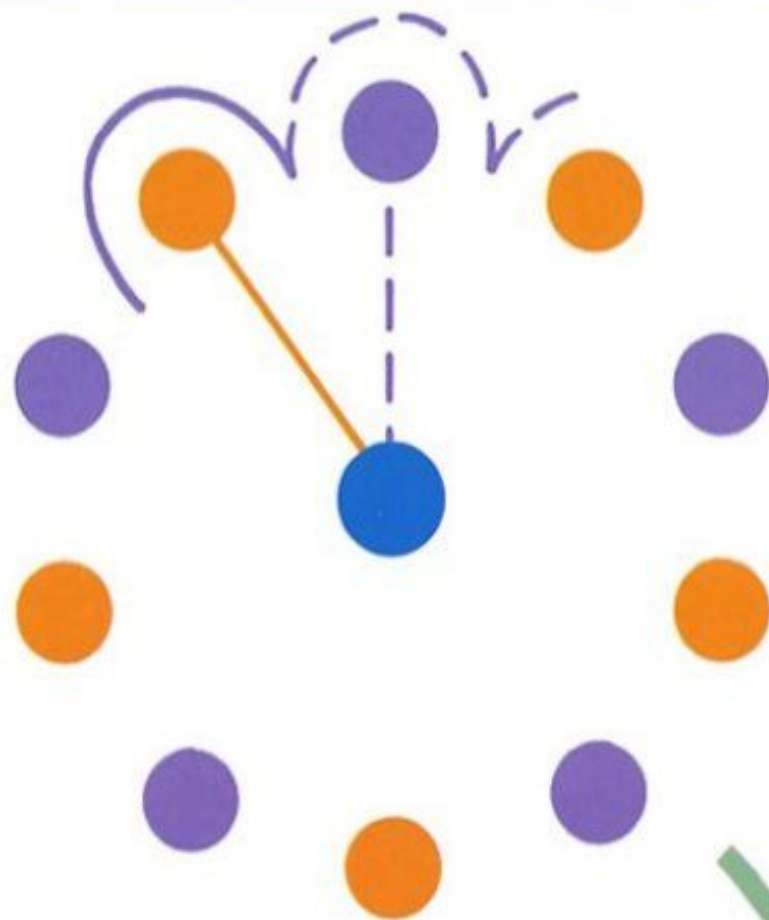
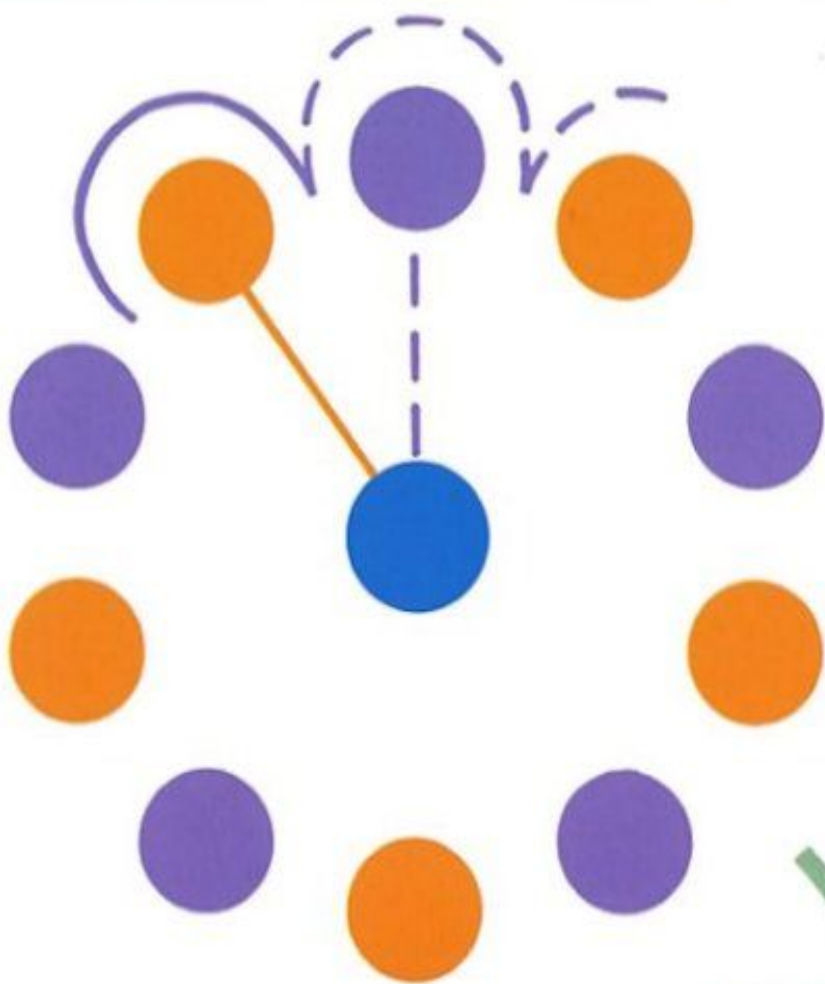

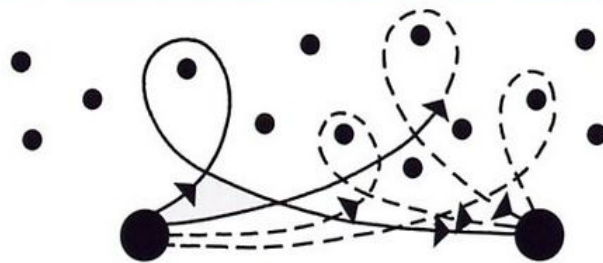

6

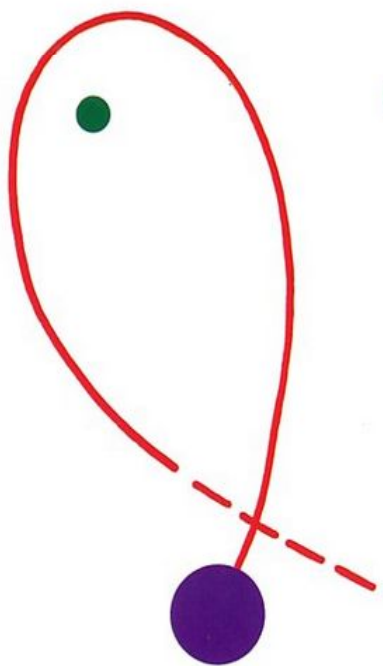

6

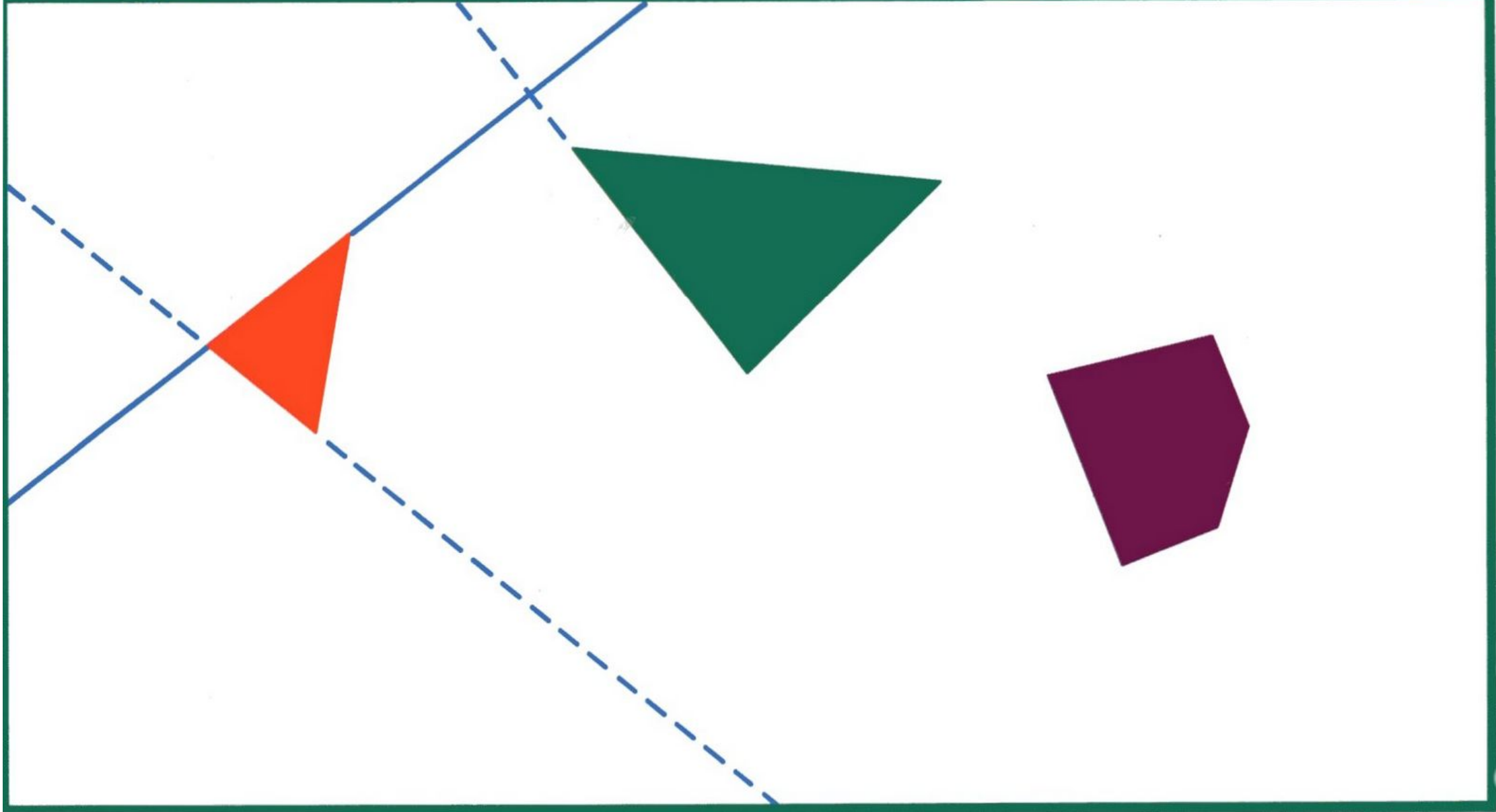
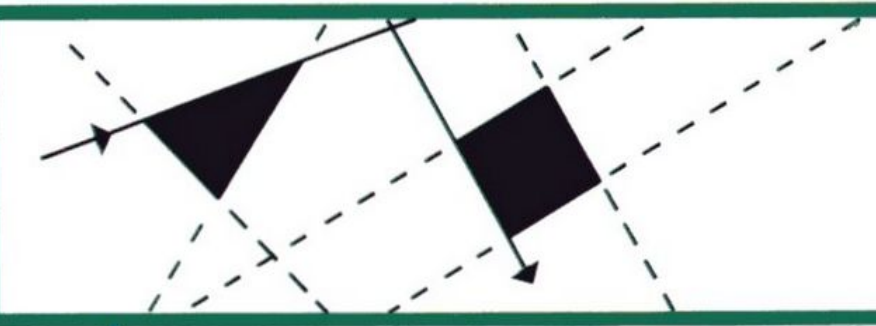
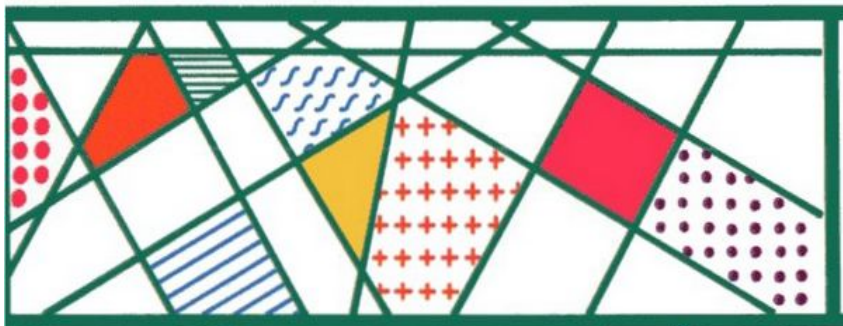

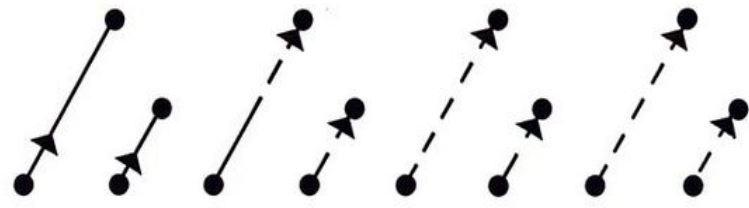
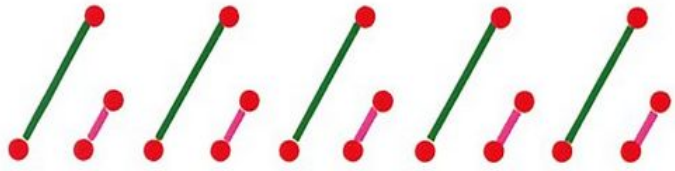

6

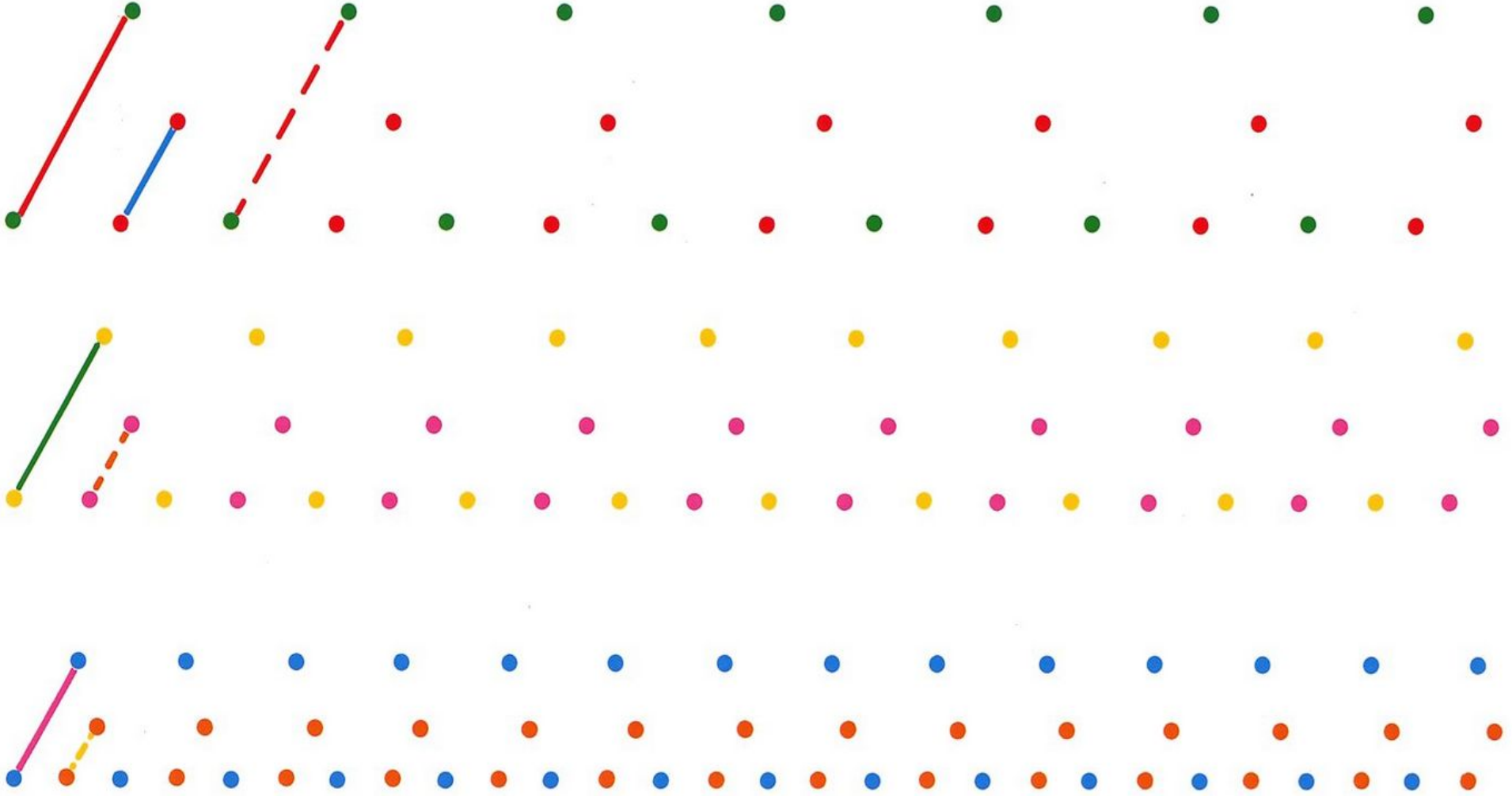

6

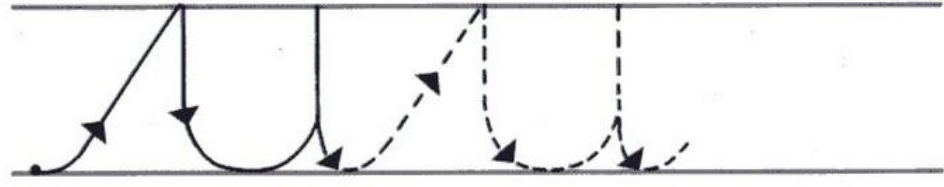
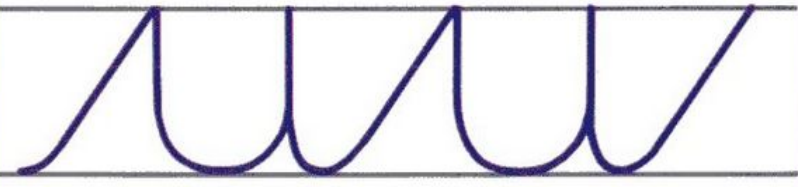

6

Handwriting practice row 1: A continuous cursive line of connected loops, colored green.

Handwriting practice row 2: A continuous cursive line of connected loops, colored grey. The first two loops are solid, and the next three are dashed. Arrows indicate the starting point and direction of the stroke.

Handwriting practice row 3: A continuous cursive line of connected loops, colored pink. The first three loops are solid, and the rest are dashed.

Handwriting practice row 4: A cursive line of connected loops, colored blue. The first two loops are solid, and the third is dashed.

Handwriting practice row 5: A cursive line of connected loops, colored orange. The first two loops are solid, and the third is dashed.

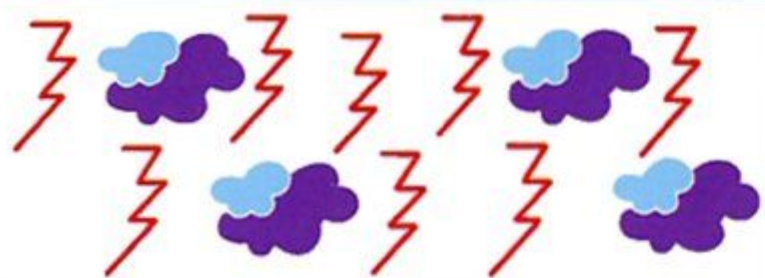

7

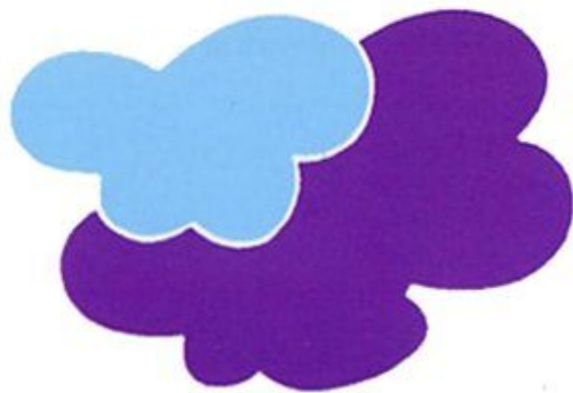
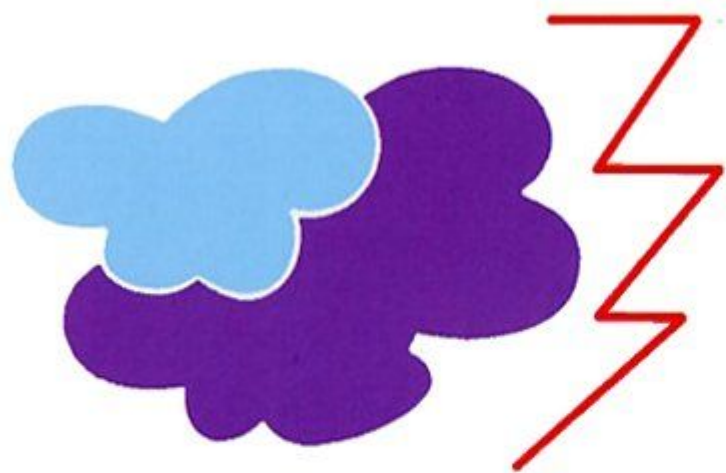



7

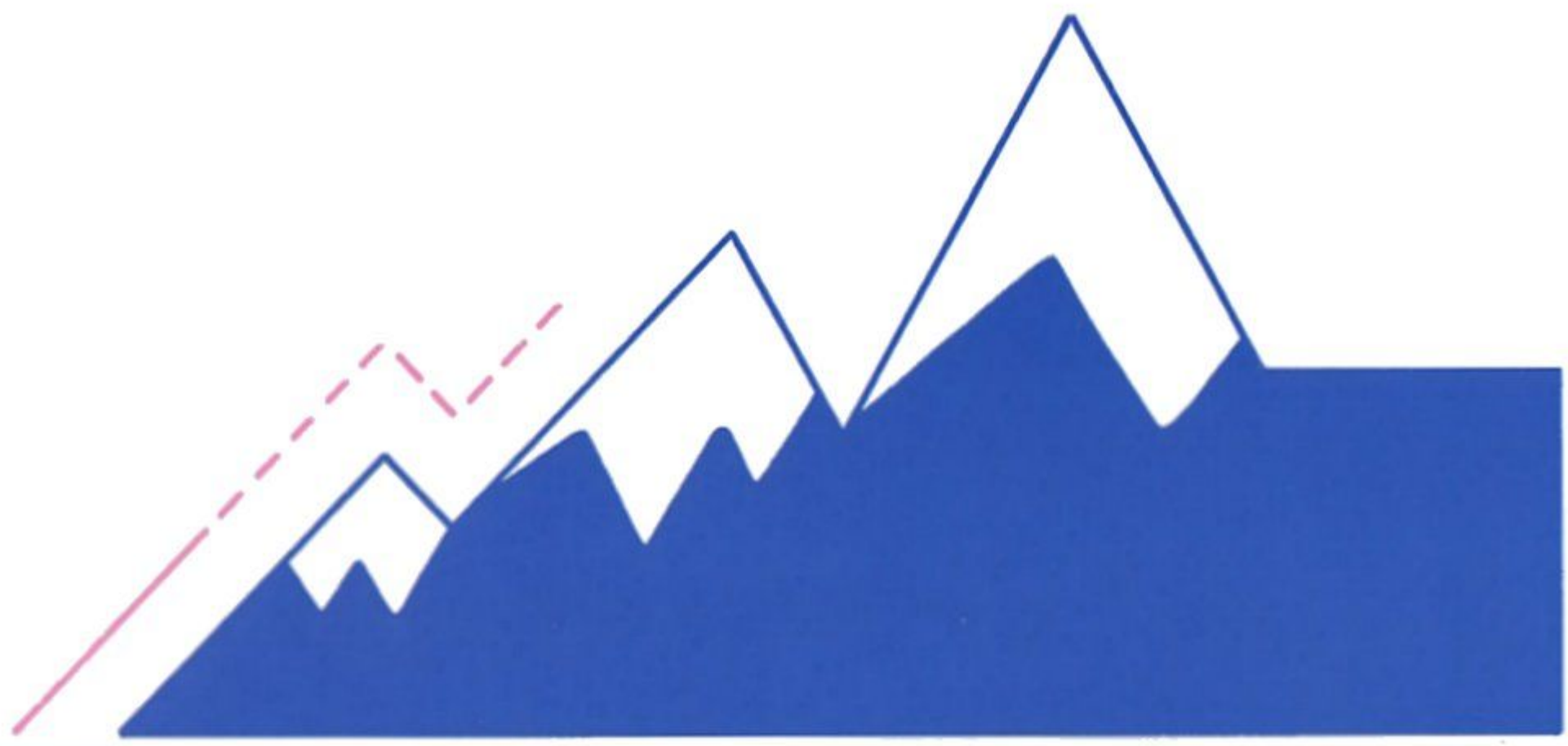



7

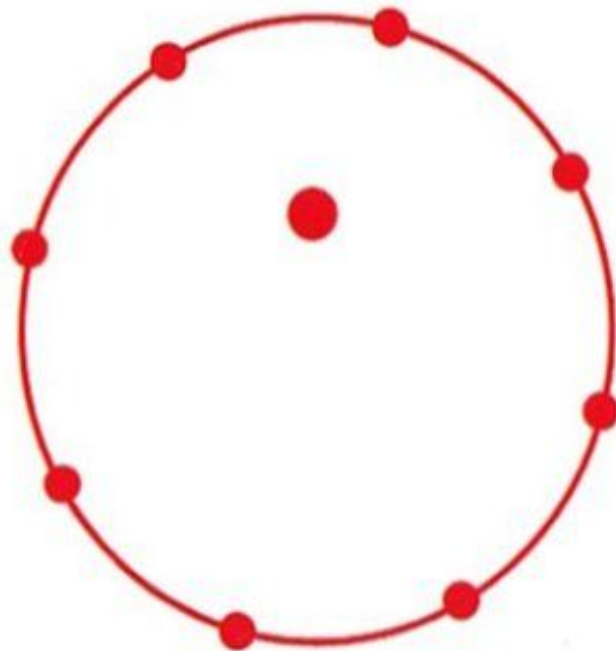
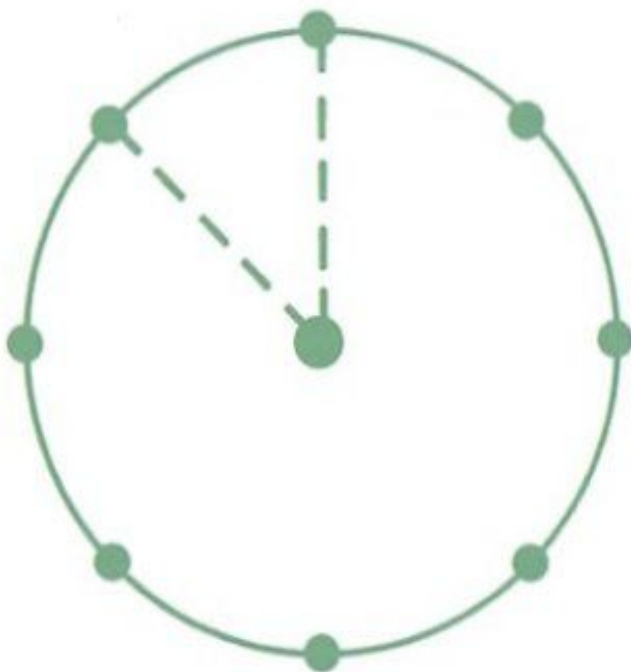
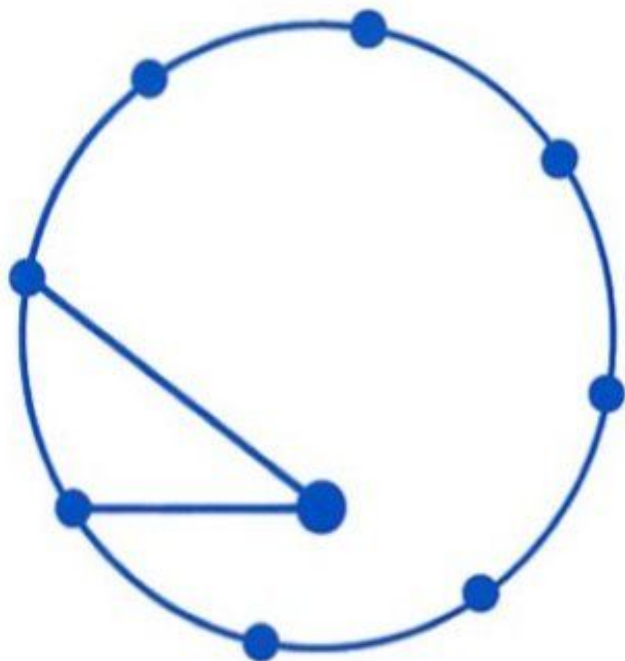

7

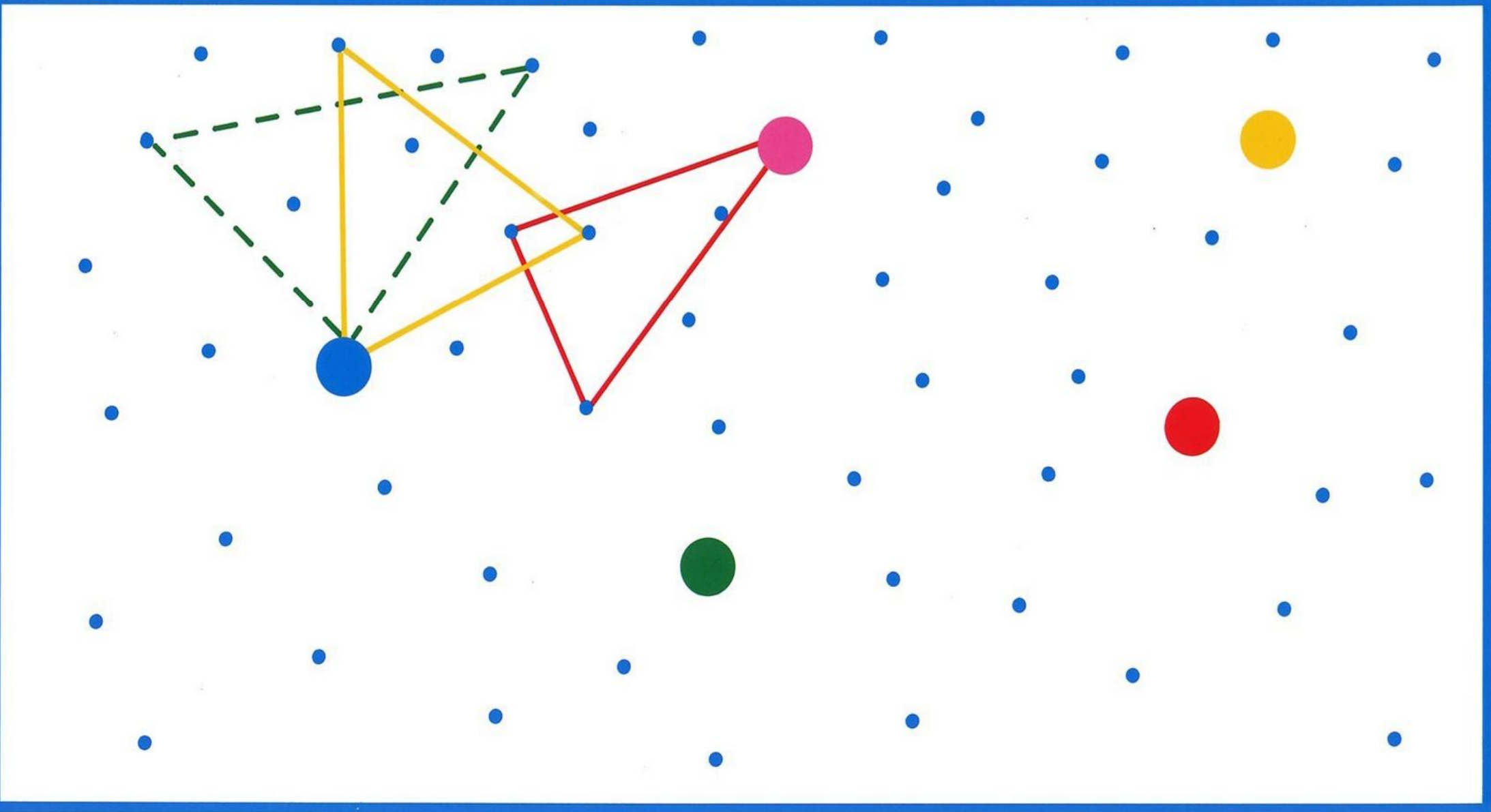
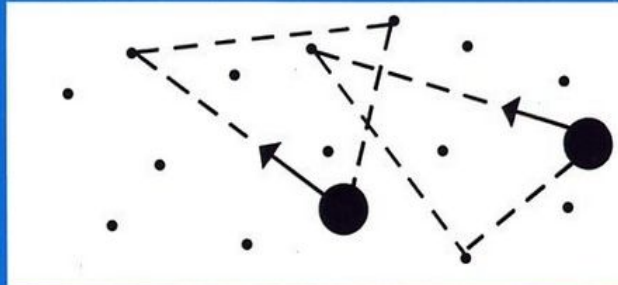
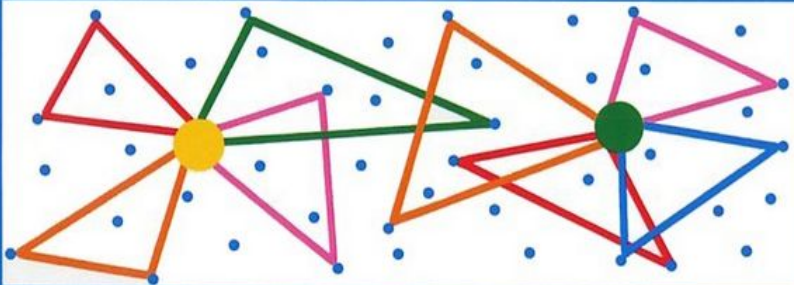

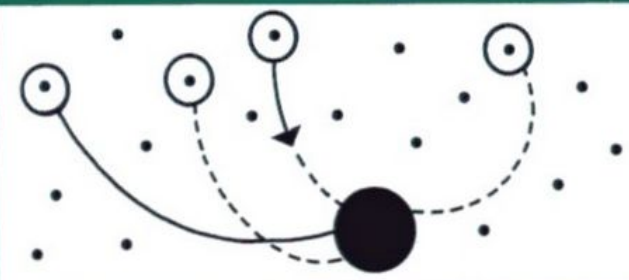

7

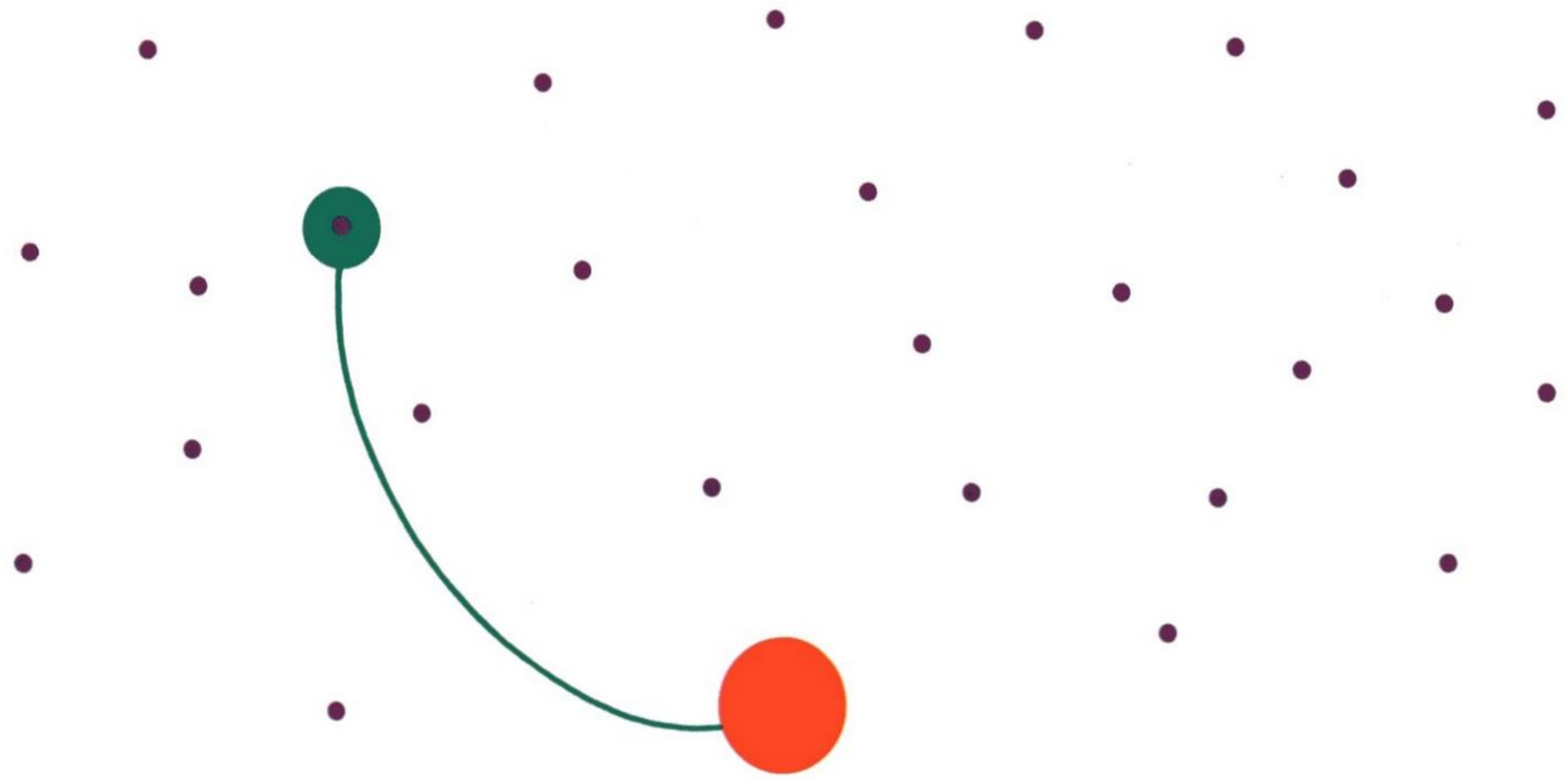

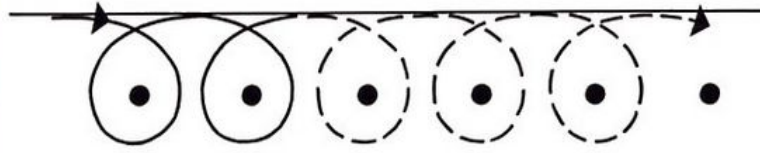
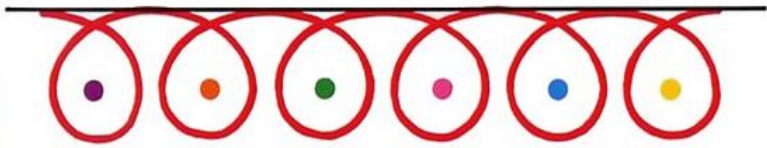

7

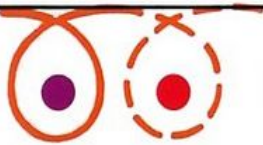
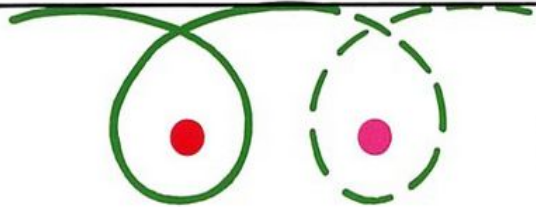
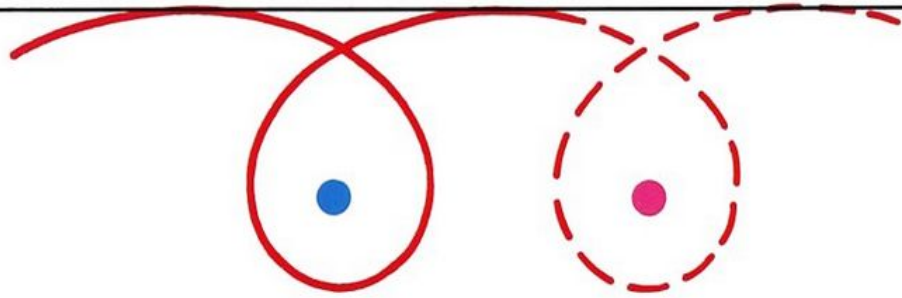

Handwriting practice row 1: A series of blue cursive loops on a four-line grid.

Handwriting practice row 2: A series of black cursive loops on a four-line grid. The first three are solid, and the last two are dashed. Arrows indicate the stroke direction: down, up, and right for the first loop; down, up, and right for the second; down, up, and right for the third; down, up, and right for the fourth; down, up, and right for the fifth.

7

Handwriting practice row 3: A long series of red cursive loops on a four-line grid.

Handwriting practice row 4: A series of yellow cursive loops on a four-line grid. The first is solid, and the others are dashed.

Handwriting practice row 5: A series of green cursive loops on a four-line grid. The first is solid, and the others are dashed.

Handwriting practice row 6: A series of purple cursive loops on a four-line grid. The first is solid, and the others are dashed.

7

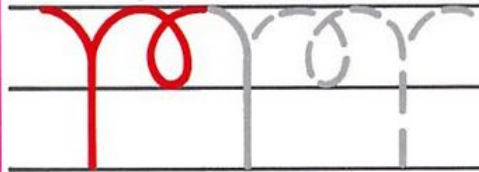
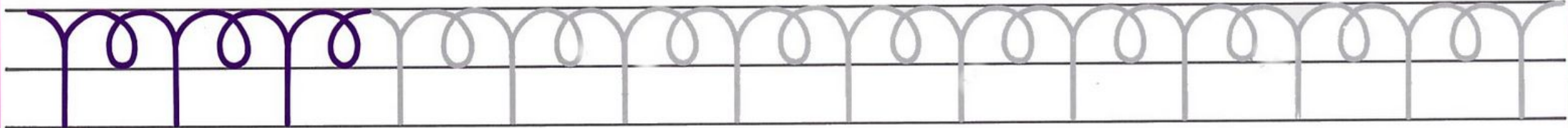
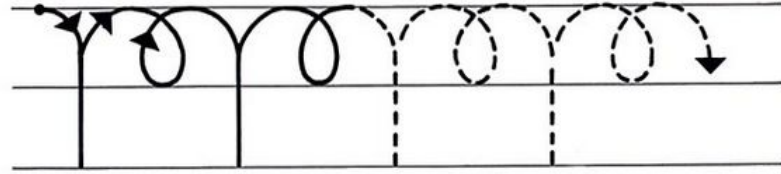
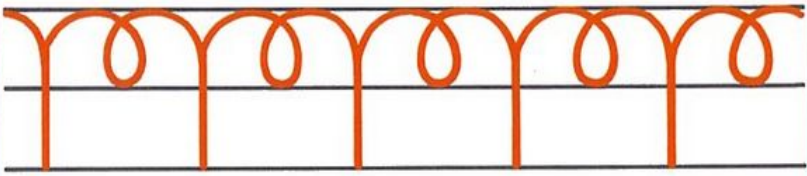

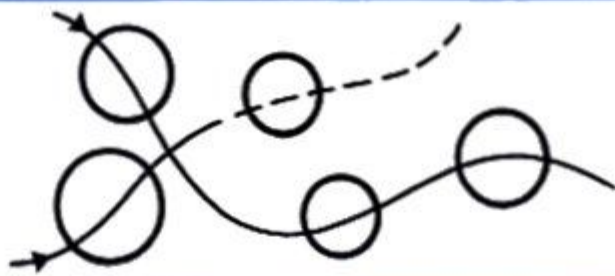

8

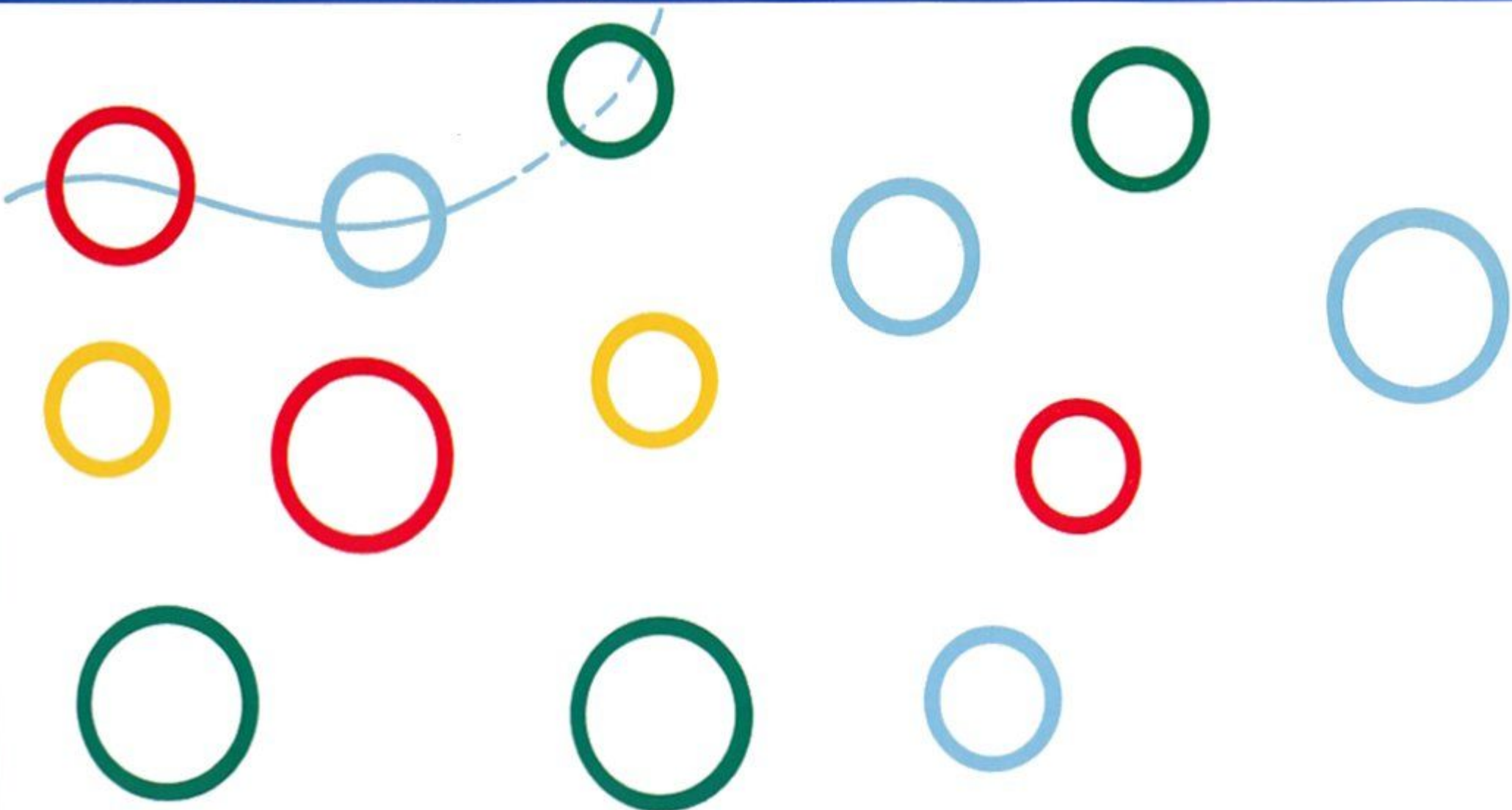



8

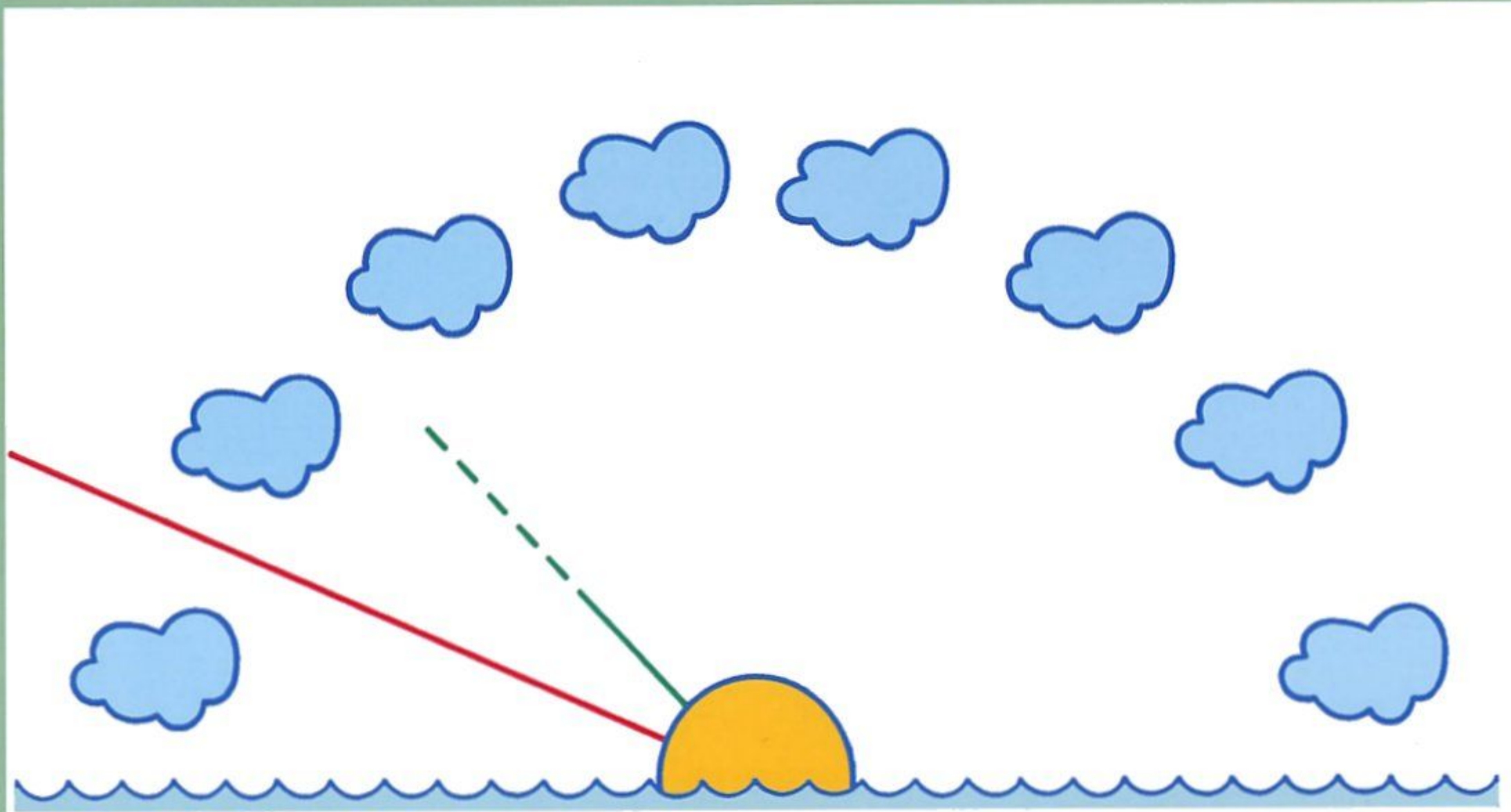



8



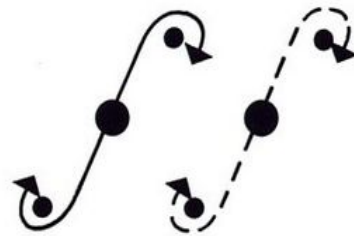
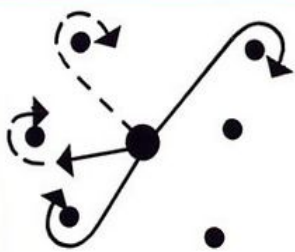
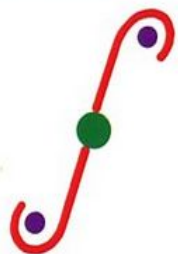

8

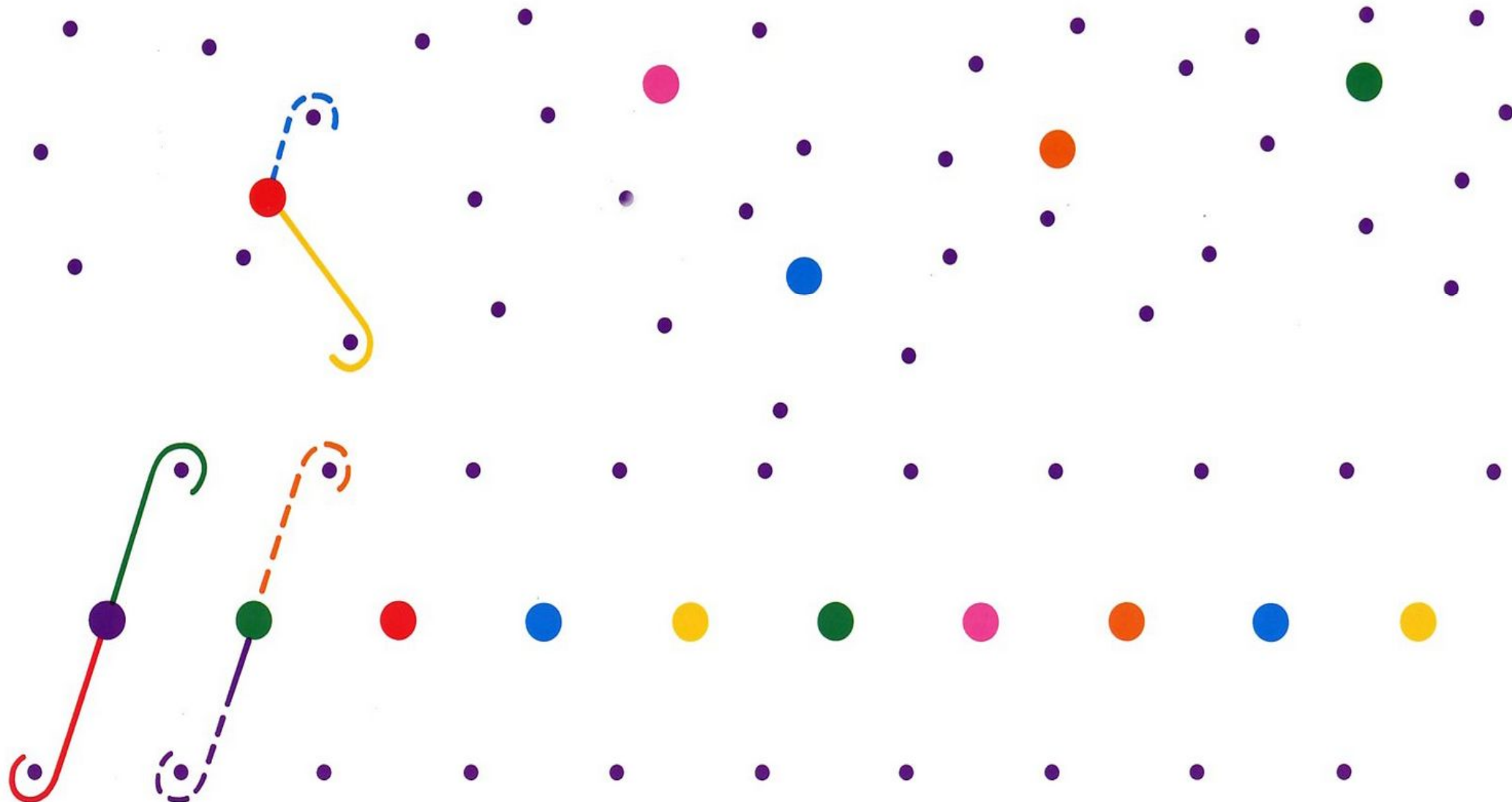

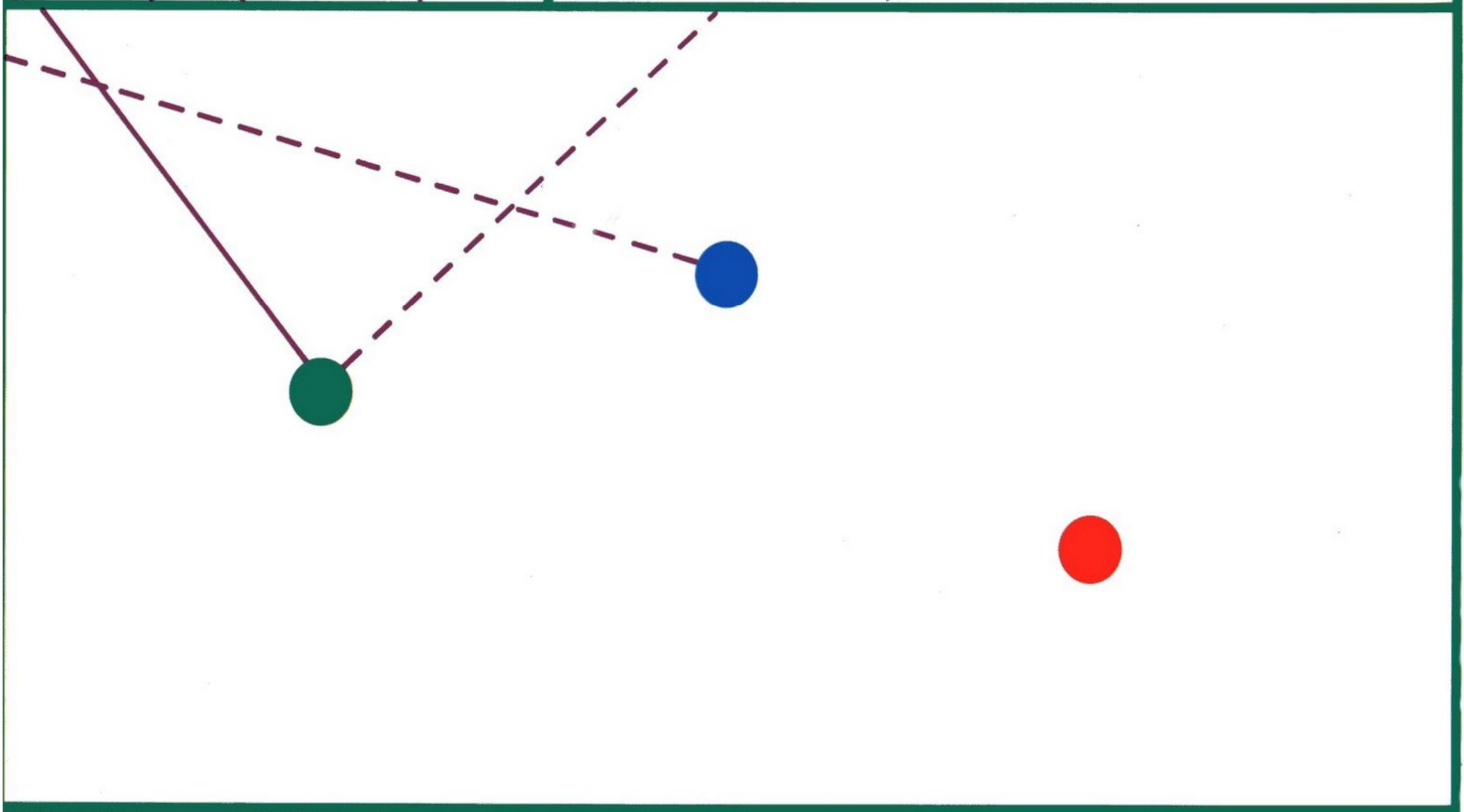
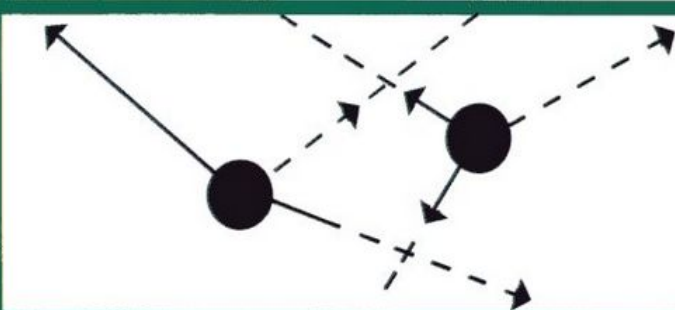
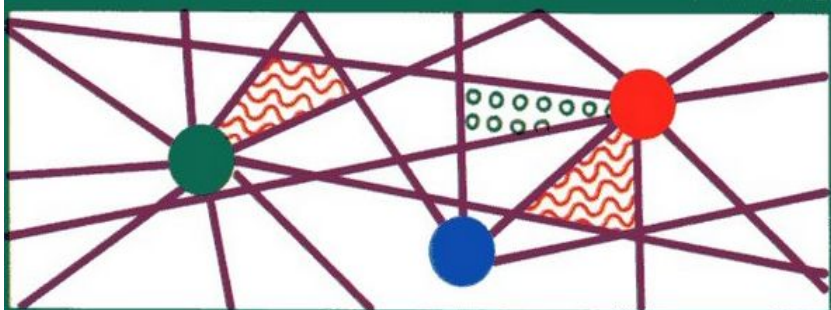

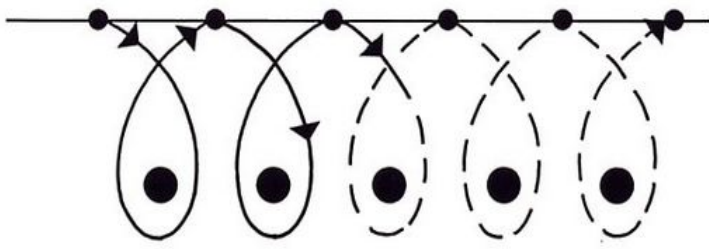
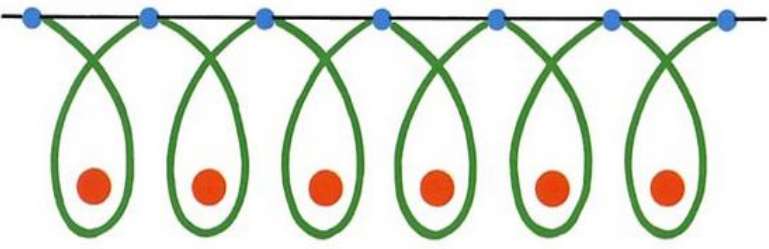

8

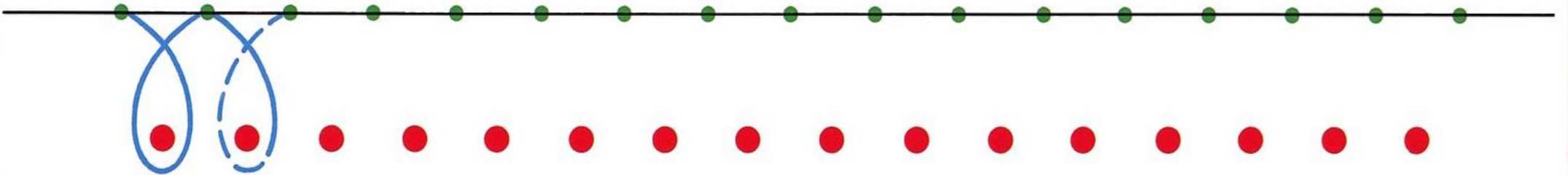
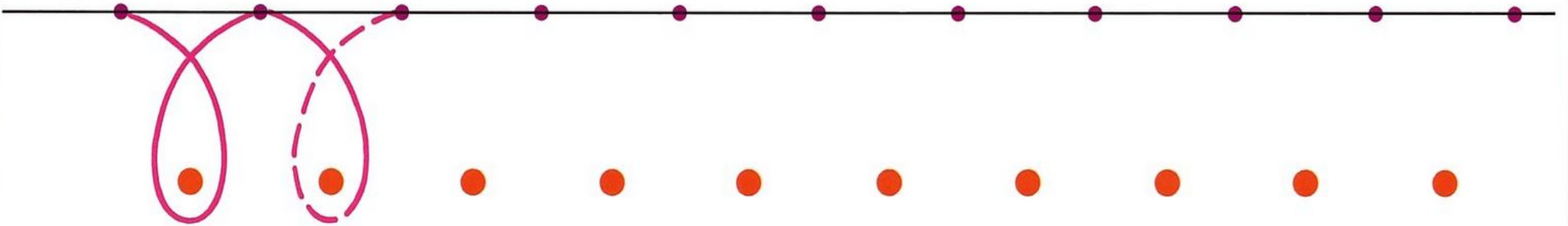
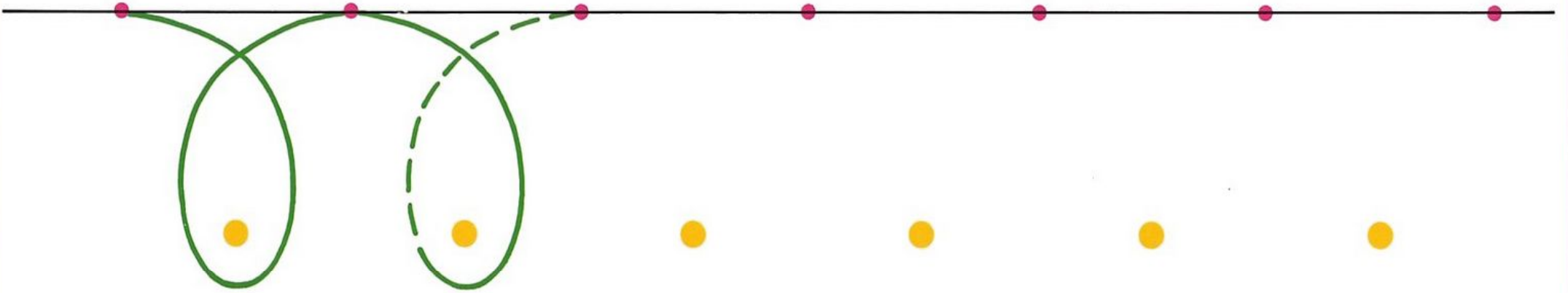

iii

iii

8

iiiiiiiiii

iii

iii

iii

Handwriting practice row 1, left section: A continuous cursive line of the letter 'u' on a four-line grid. The first 'u' is tall, reaching the top line, while the others are shorter, reaching the middle line.

Handwriting practice row 1, right section: A continuous cursive line of the letter 'u' on a four-line grid. The first 'u' is tall, reaching the top line, while the others are shorter, reaching the middle line. Small black arrows indicate the direction of the pen strokes.

8

Handwriting practice row 2: A continuous cursive line of the letter 'u' on a four-line grid. The first two 'u's are yellow, and the remaining 'u's are light gray.

Handwriting practice row 3: A continuous cursive line of the letter 'u' on a four-line grid. The first two 'u's are green, and the remaining 'u's are light gray.

Handwriting practice row 4: A continuous cursive line of the letter 'u' on a four-line grid. The first two 'u's are pink, and the remaining 'u's are light gray.

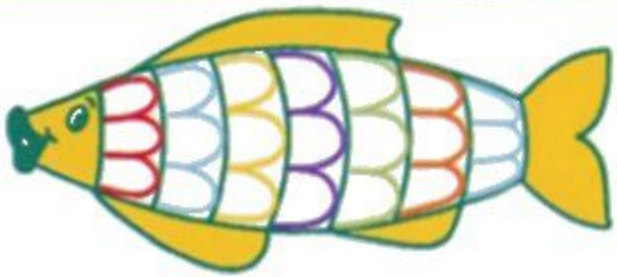

9

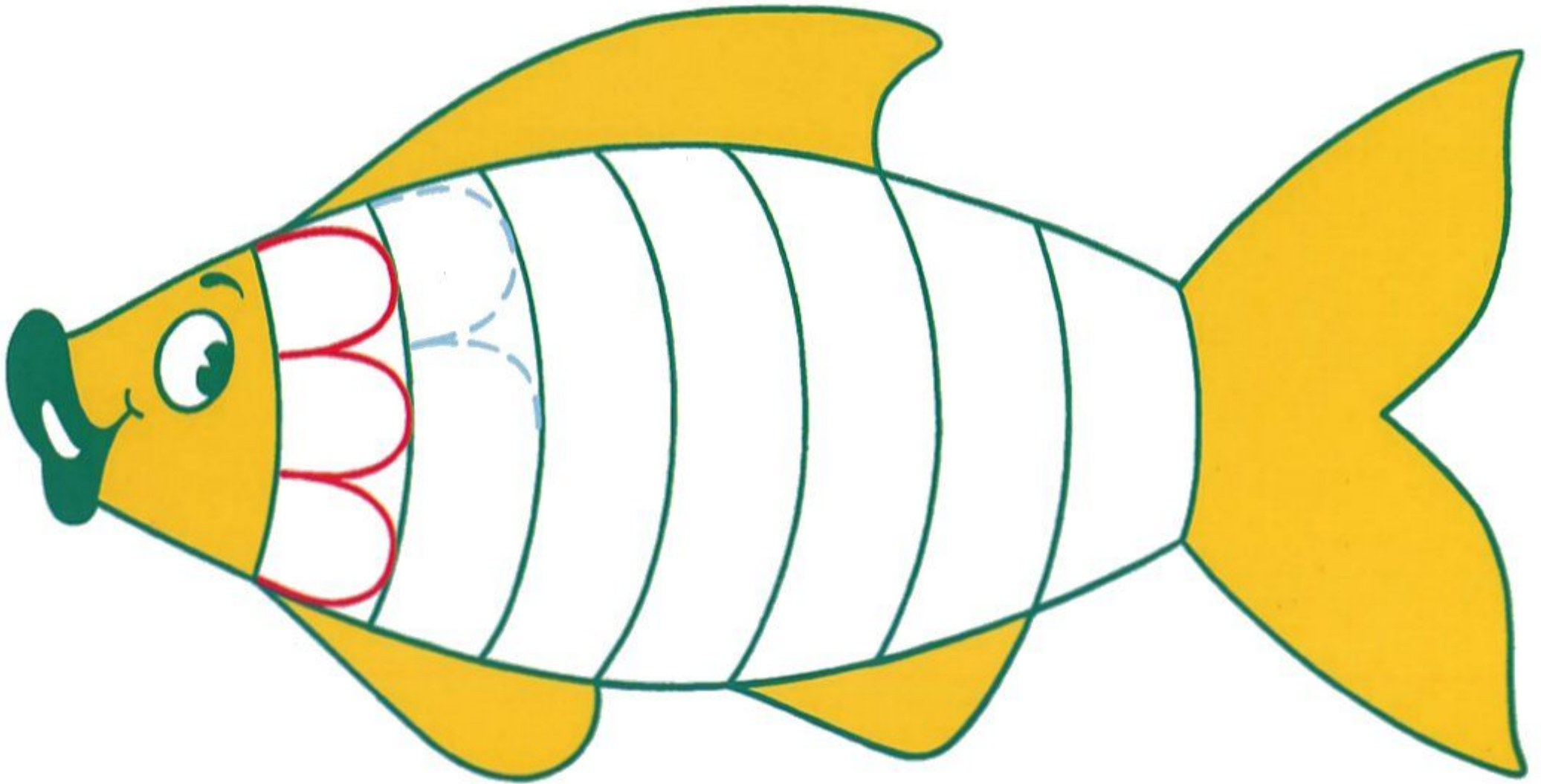



9

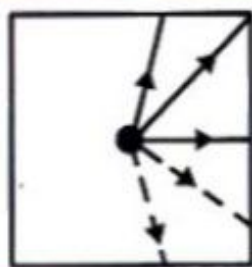

9

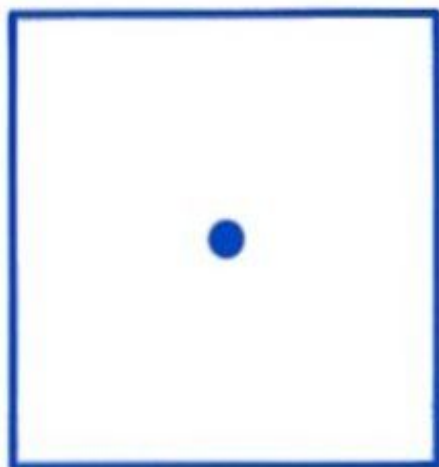
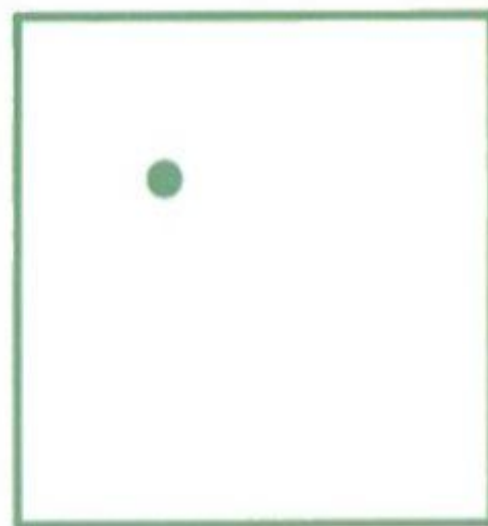
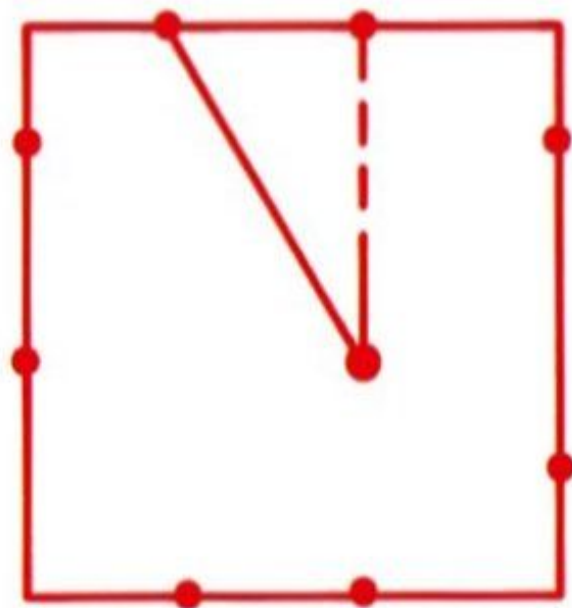

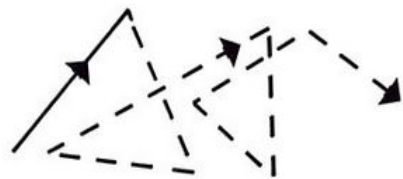
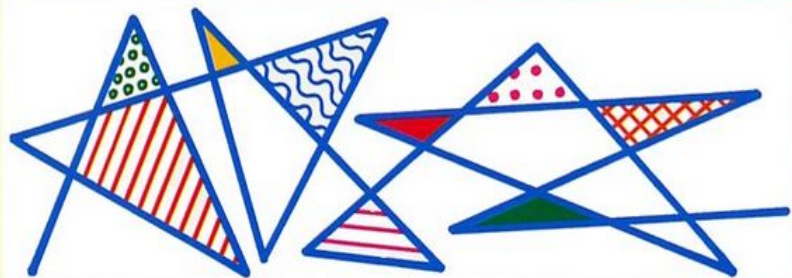

9

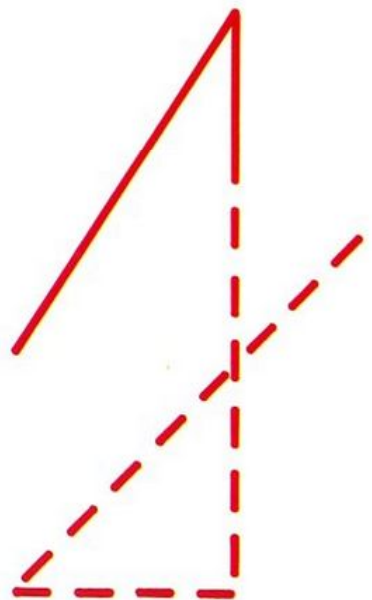

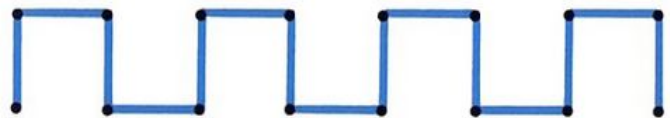

9

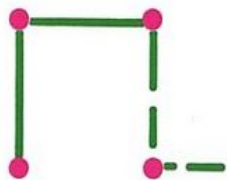
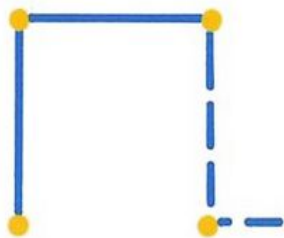
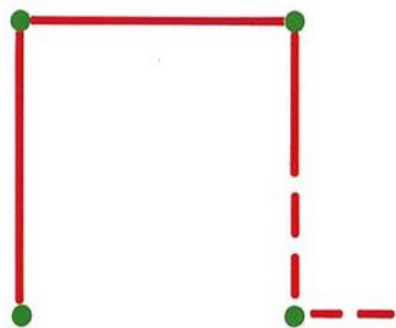

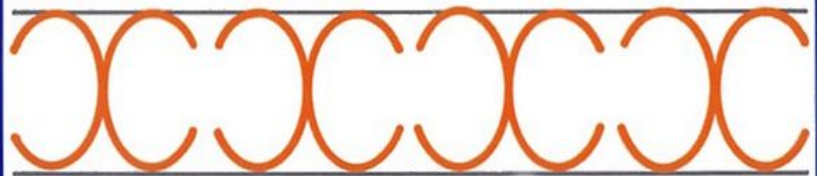

9

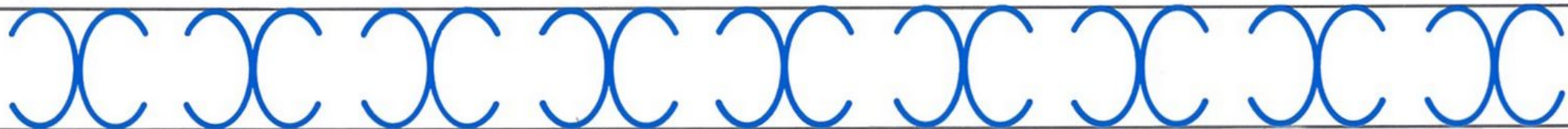

elluelluelli

elluelluelli

9

elluelluellielluelluellielluelluellielluelluelli

elluelluelli

elluelluelli

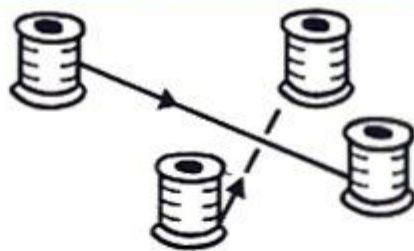
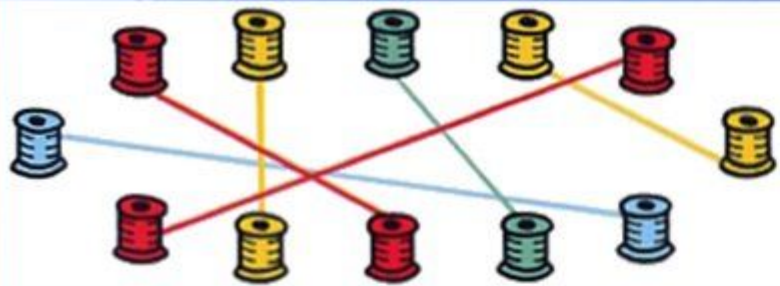

10

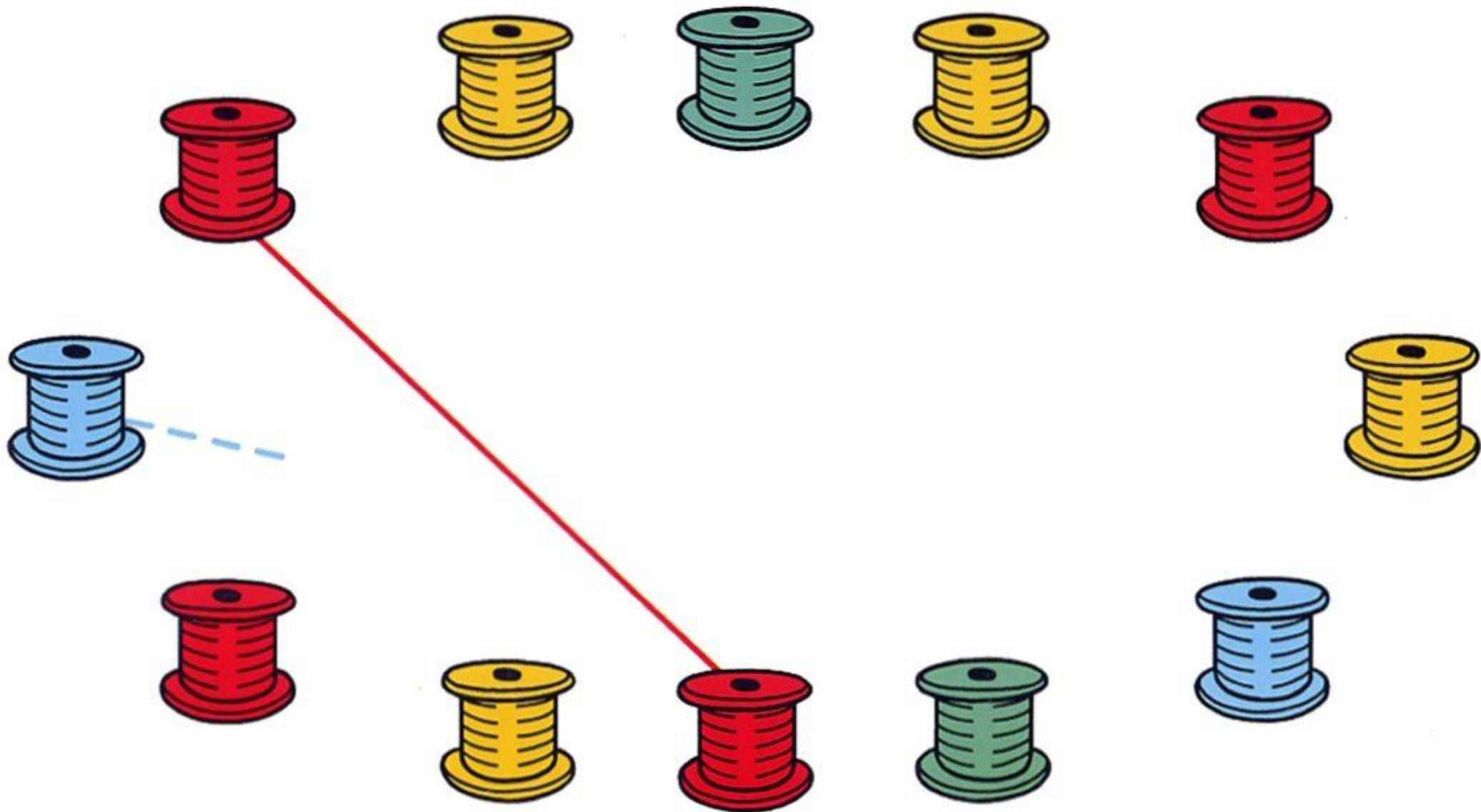

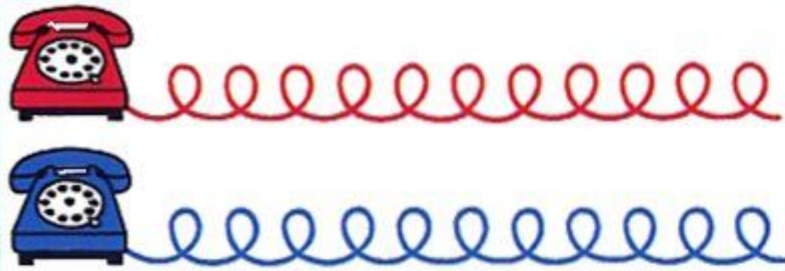

10



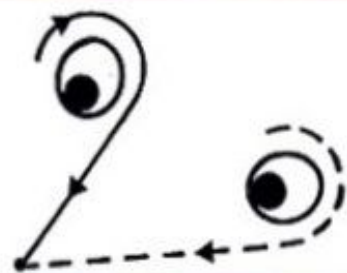

10

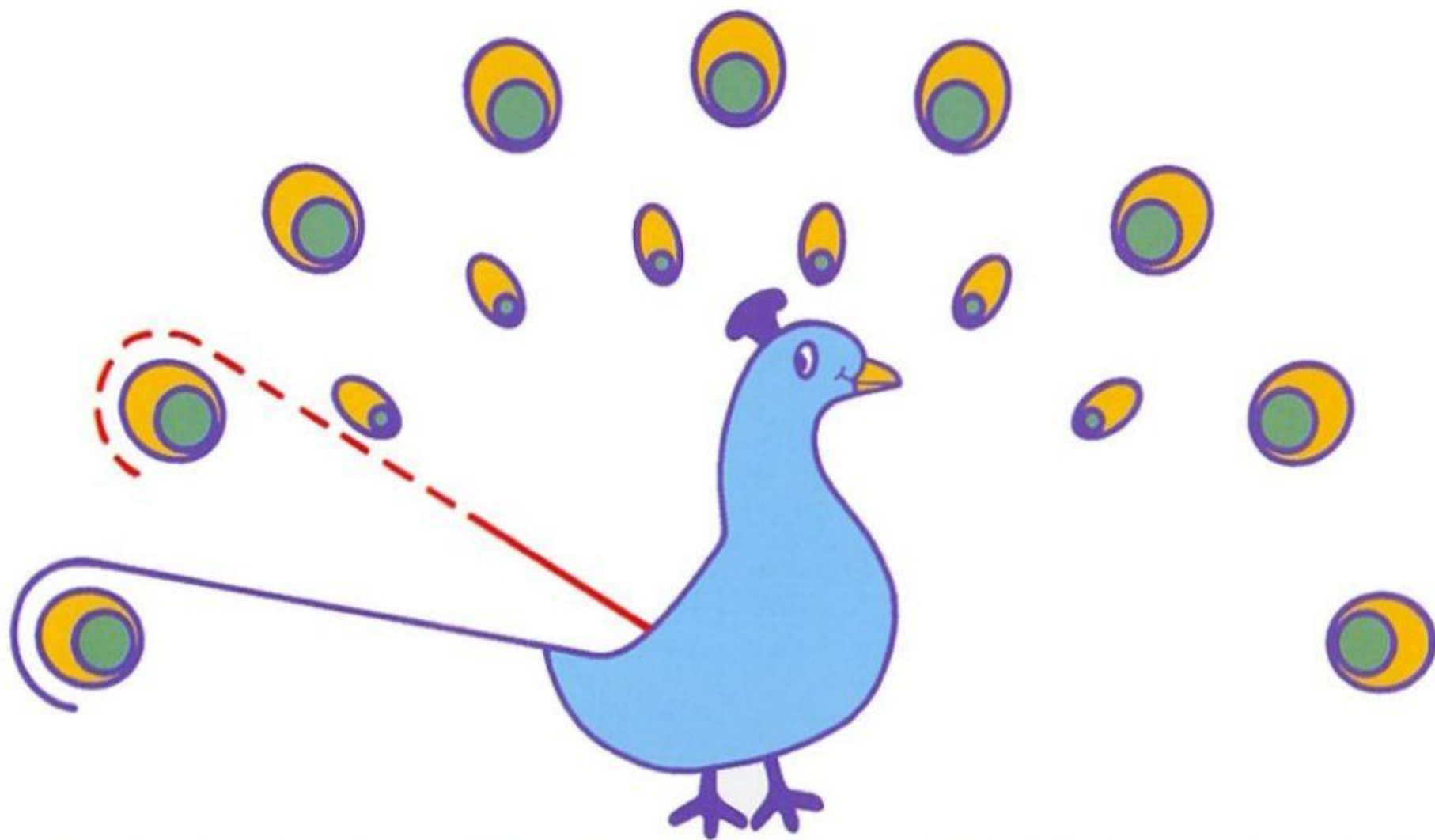

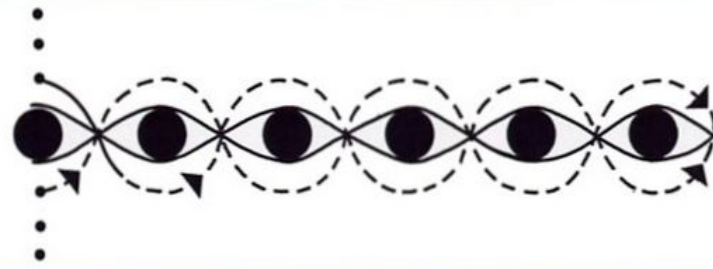
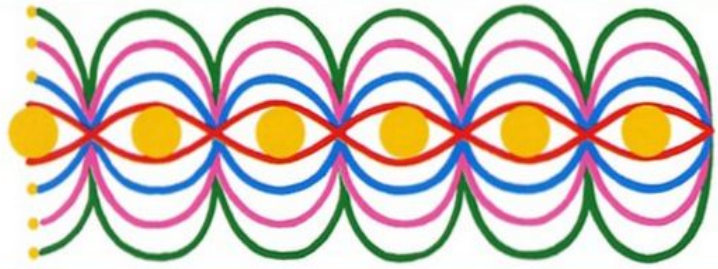

10

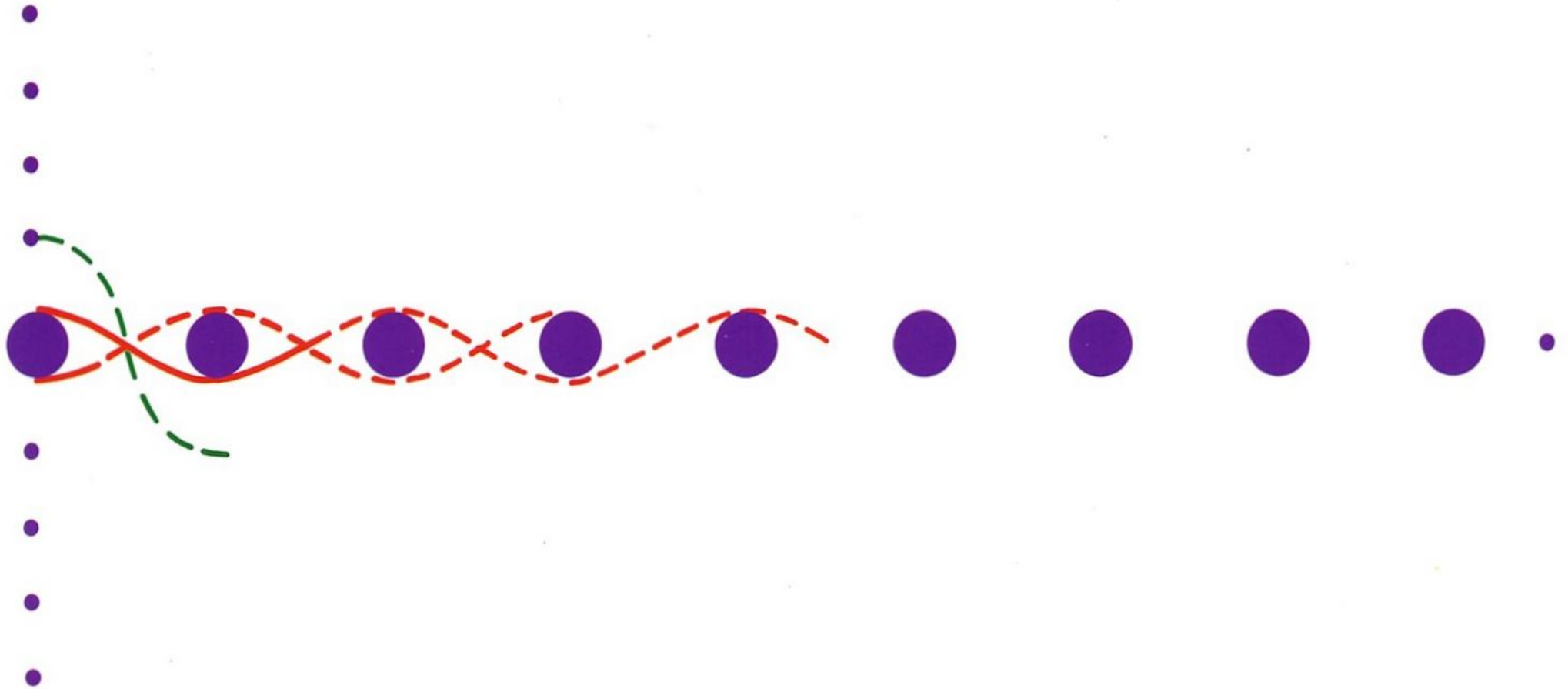

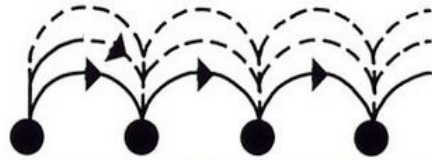
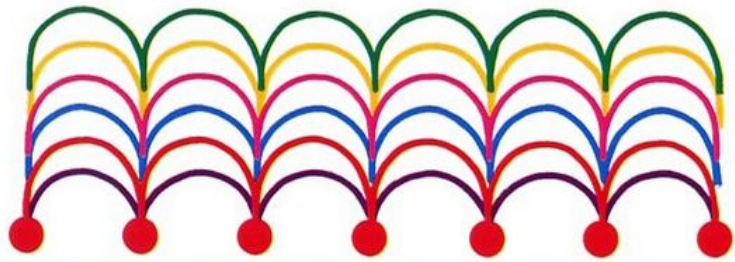

10

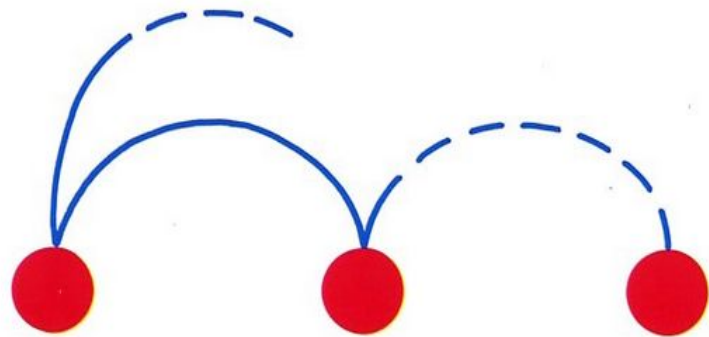

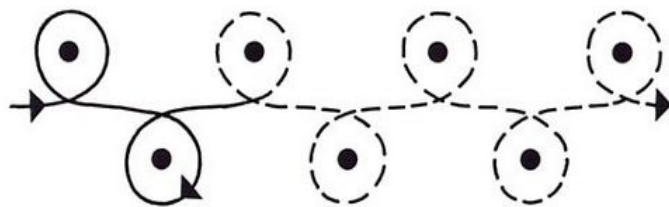
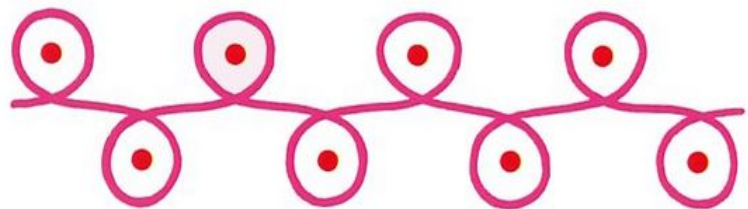

10

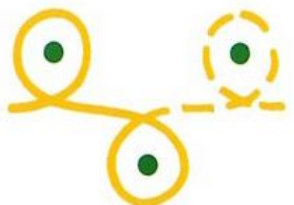
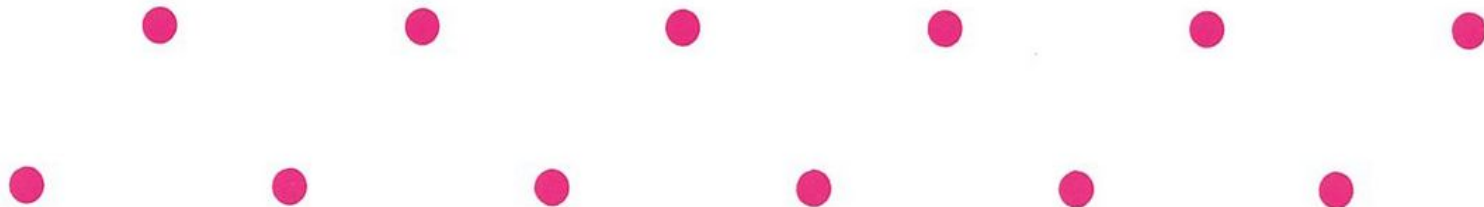
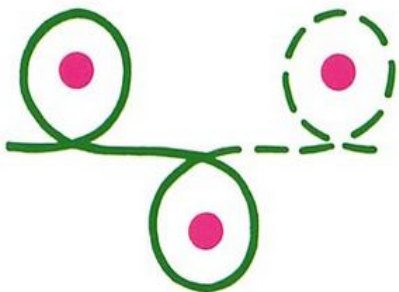
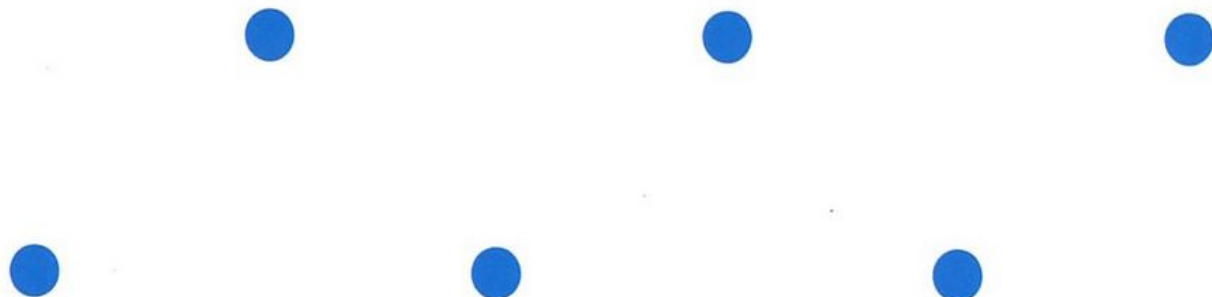
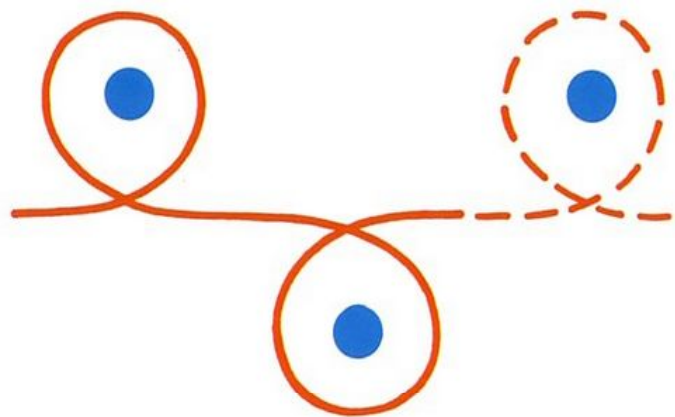

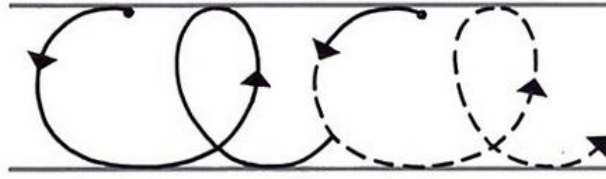
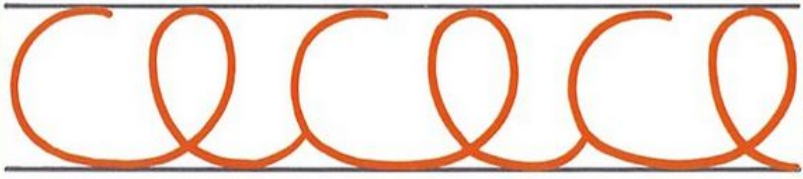

10

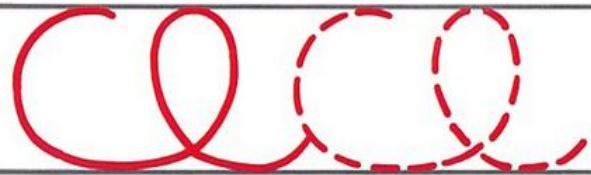
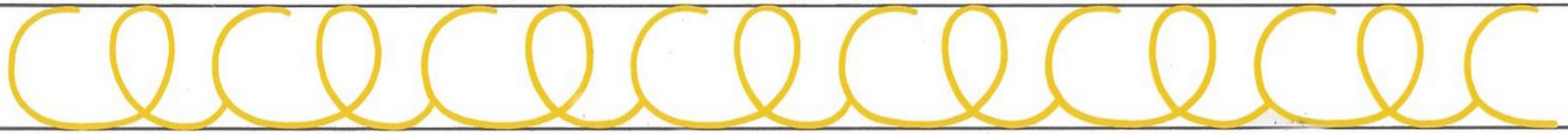

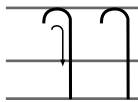
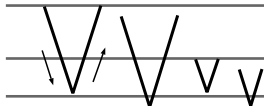
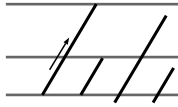
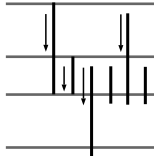

ll

ss

z

o o

o o

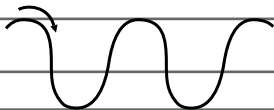
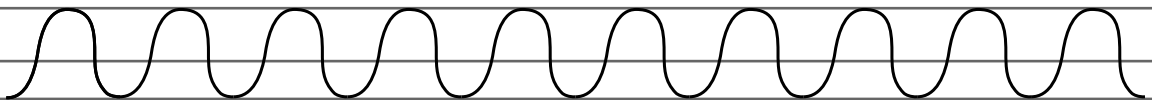
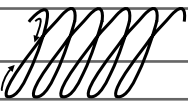
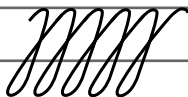
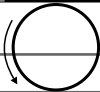
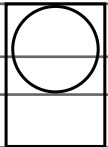
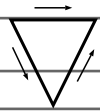
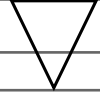
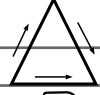

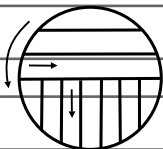
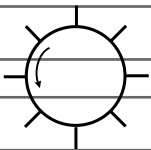
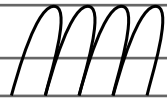
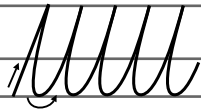

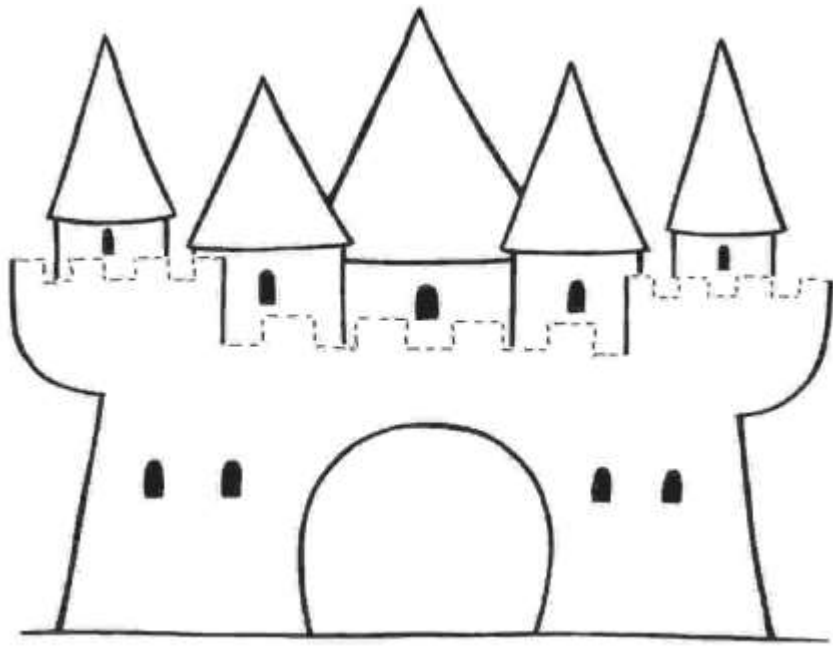





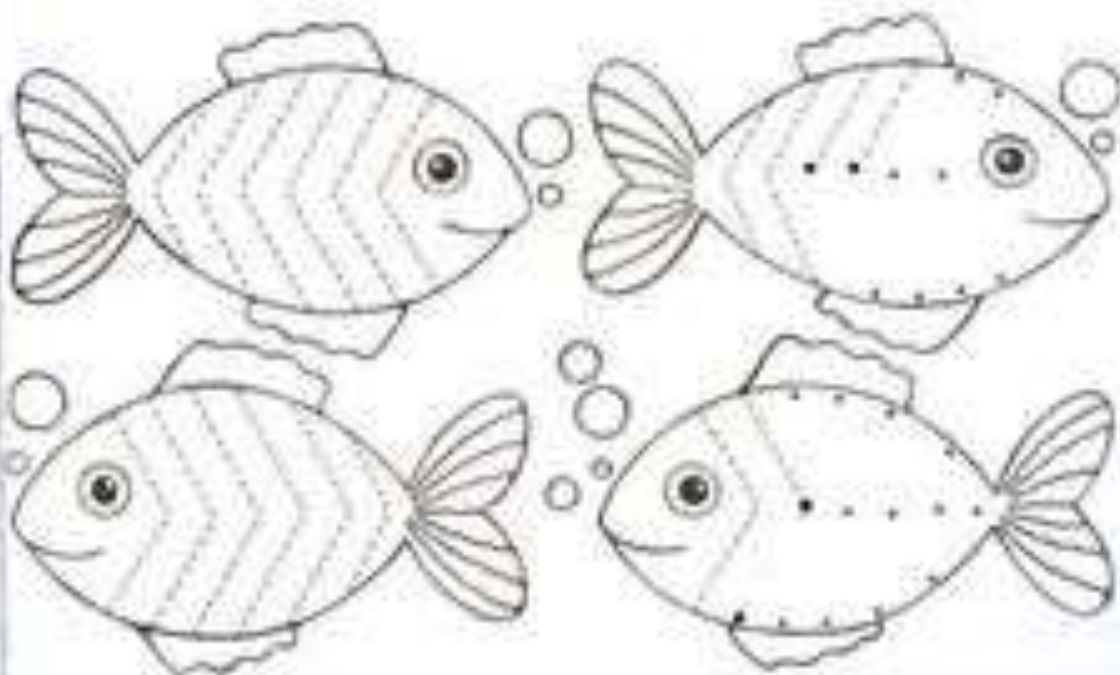
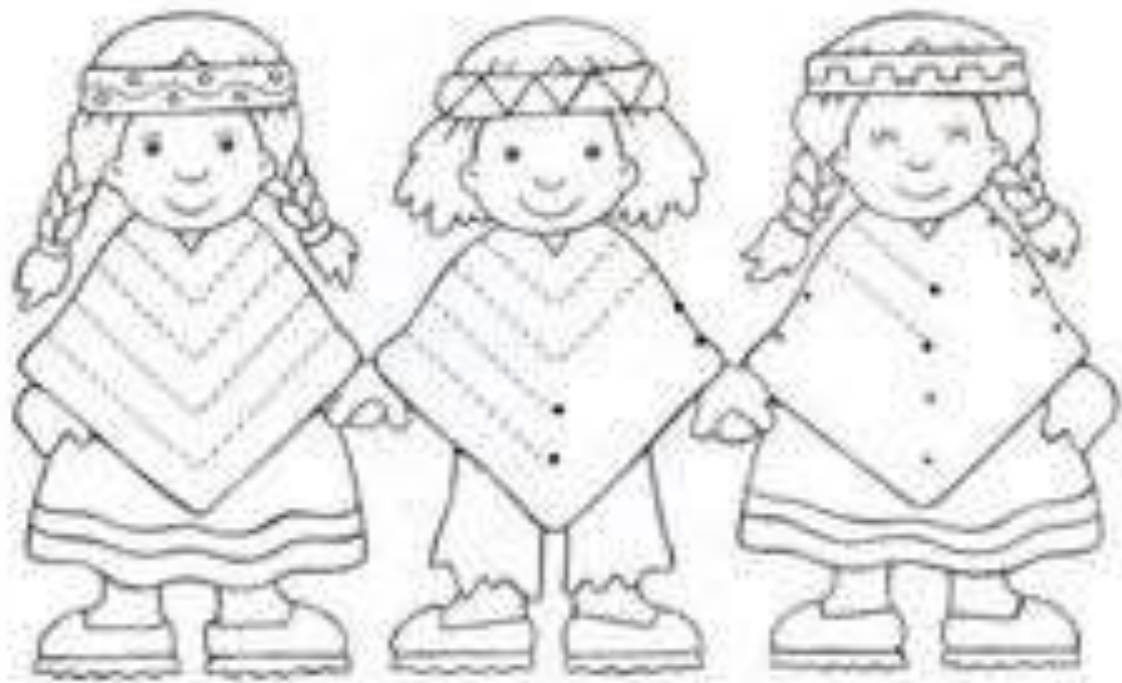





Зайчата на
прогулке.



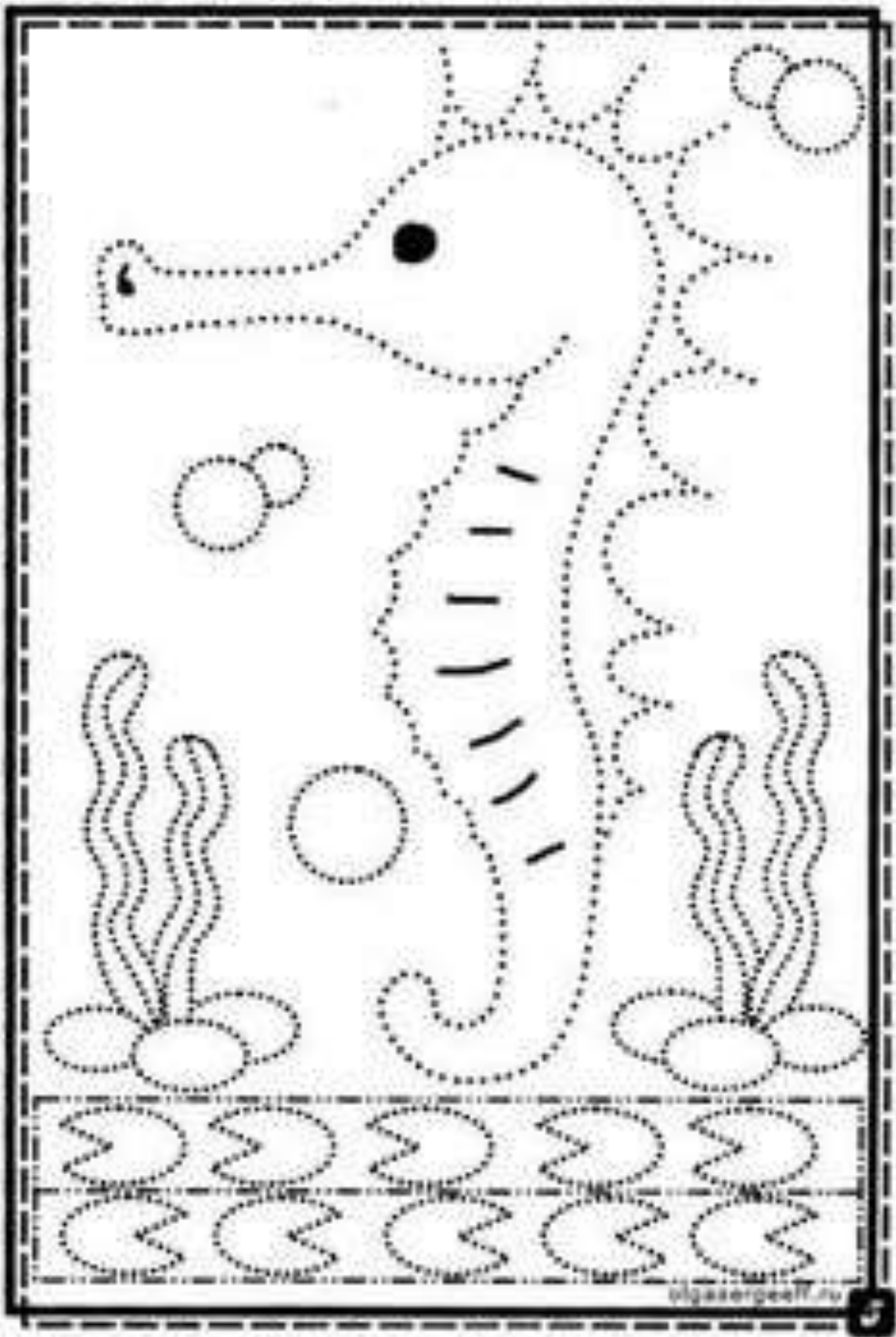

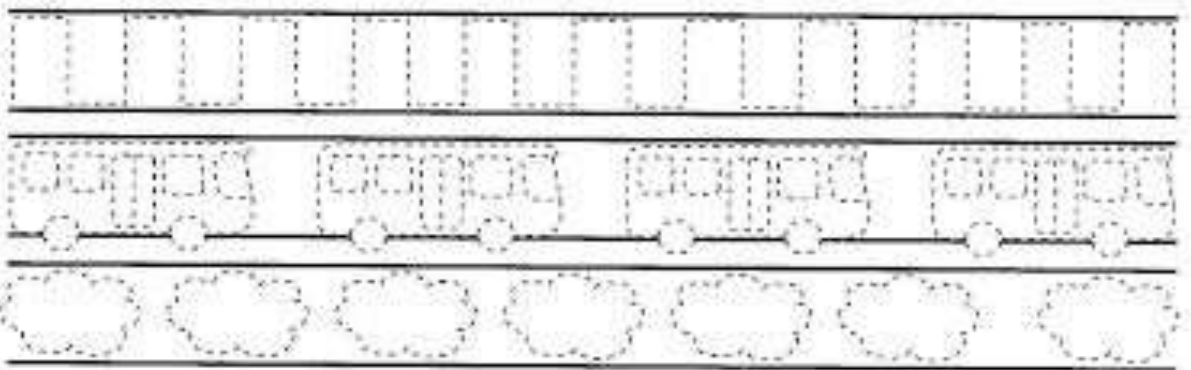
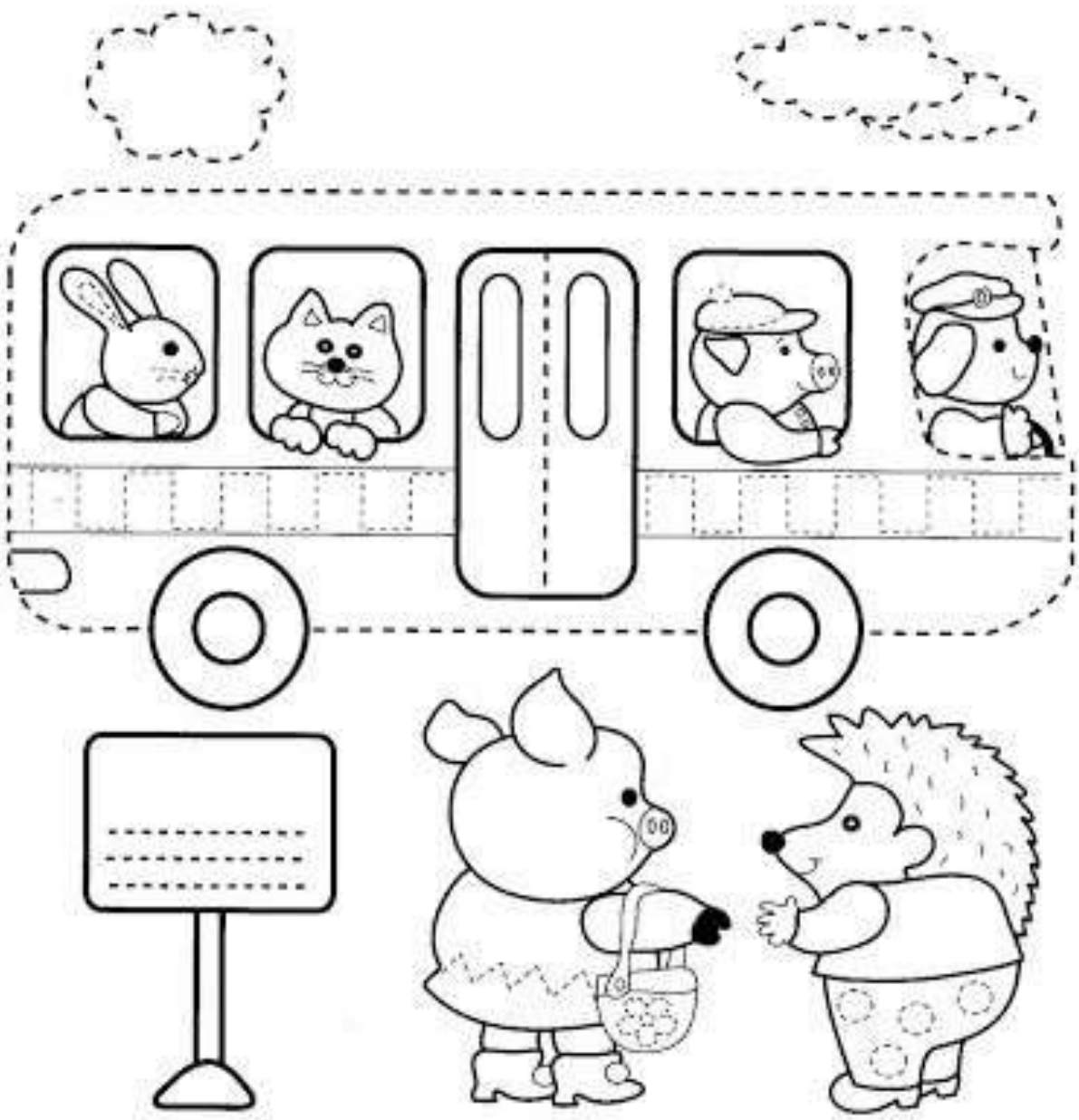

Blank box for writing or labeling.



LA OVERTURA EN EL FONDO DEL MAR
• DELINEA Y COLOREA



© 2006

• DIBUJA LAS MANCHAS DE LOS HONGOS.

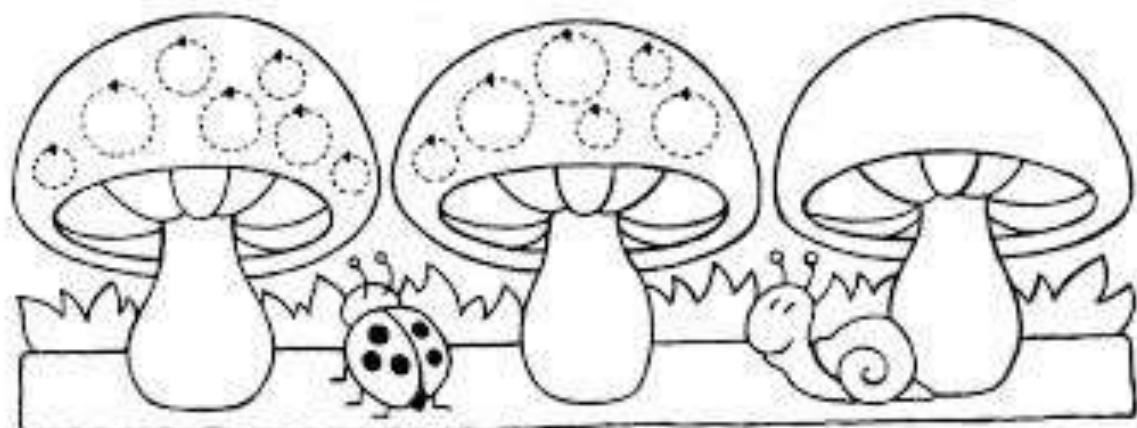

• LLENA DE NARANJAS LOS ÁRBOLES.

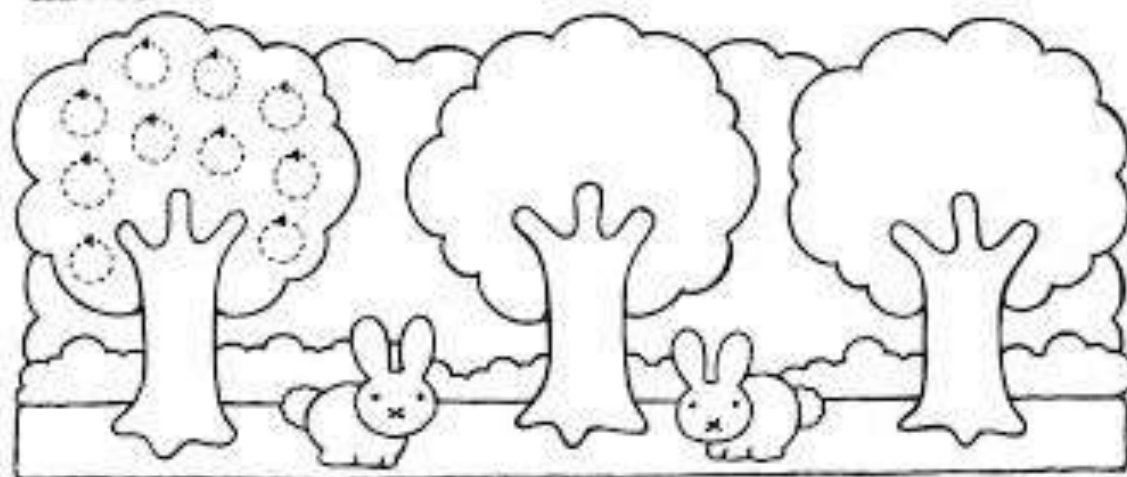

• HAZ LOS LUNARES DE LOS PAÑUELOS DE LAS NEGRITAS.



GoFundMe

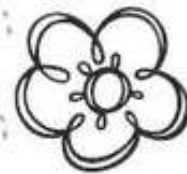
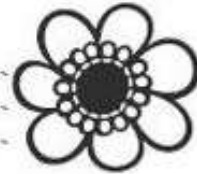



Since a station star road,
try to fly hourly boat,
Go to it!

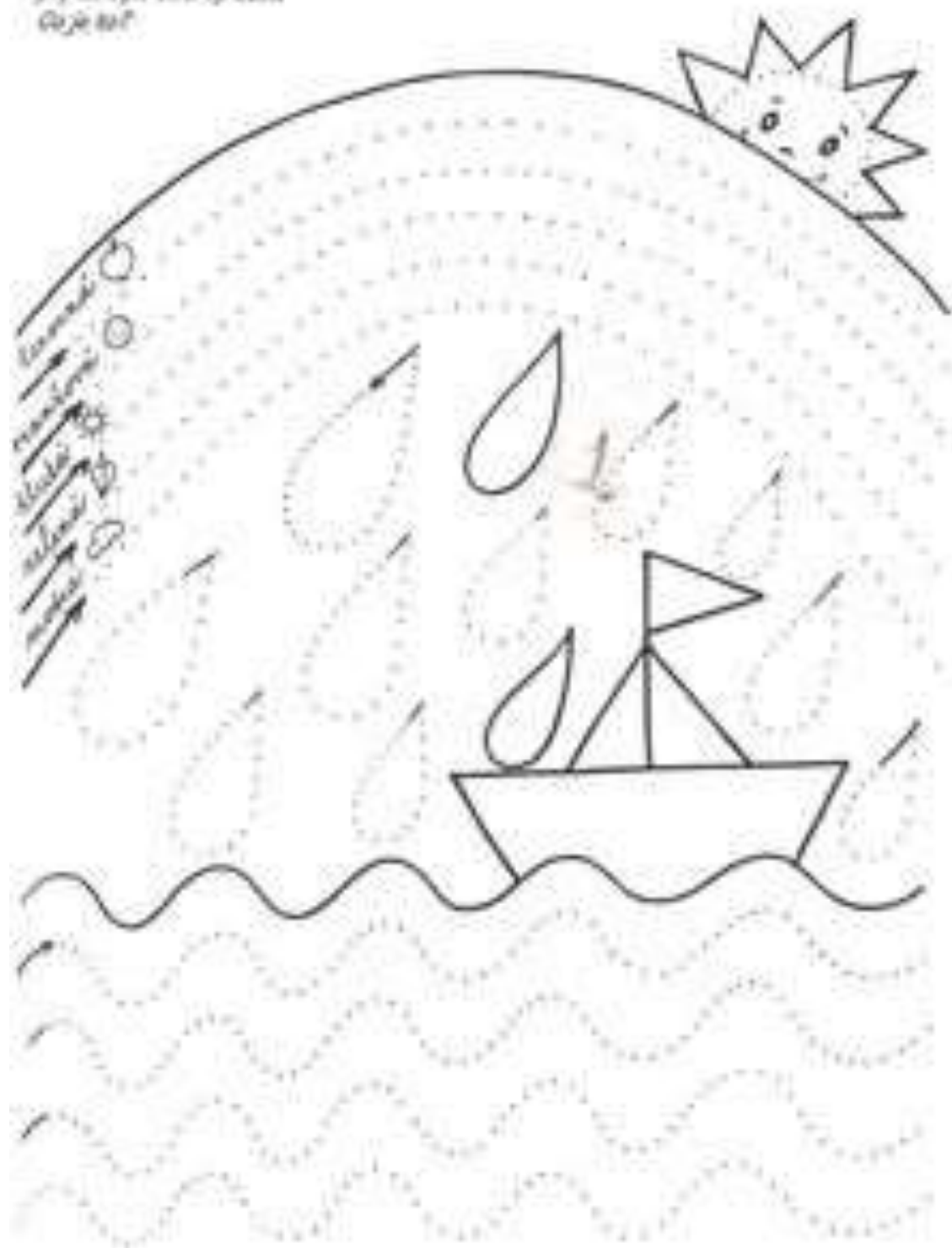

je rychlejší nežli rybka?

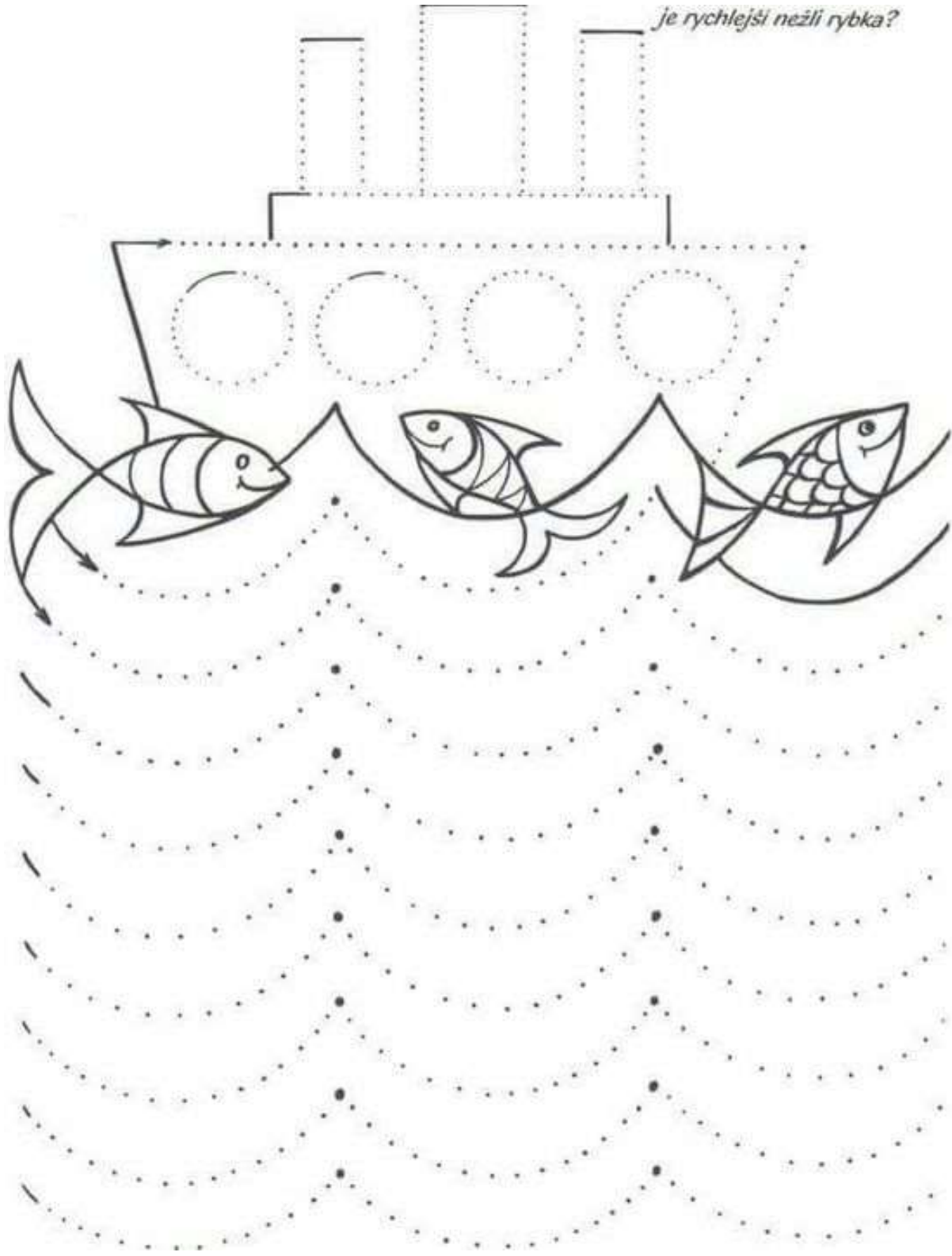



Обој, исечи и порђај слике од највеће до најмање.

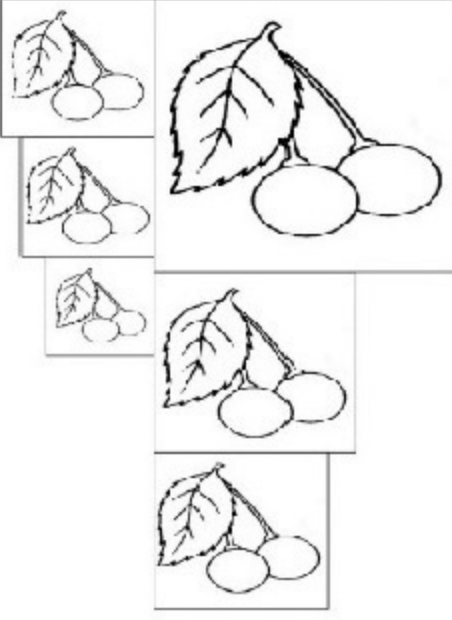

Обој различито!

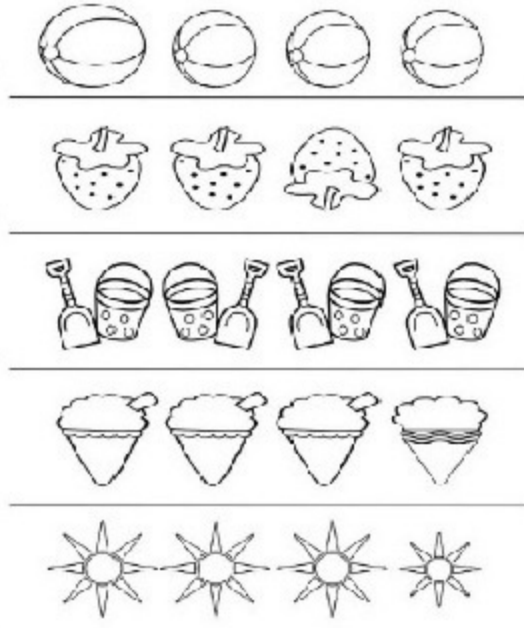

Исци, па залепи картице правилно!



Помози пазљивама да стигну до дрвета.



Обој како је започето!

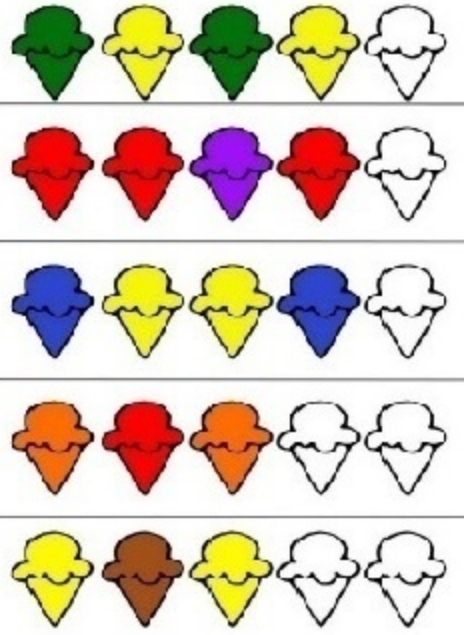

Исеци папир да дојеш до слике. Прати тачкице.

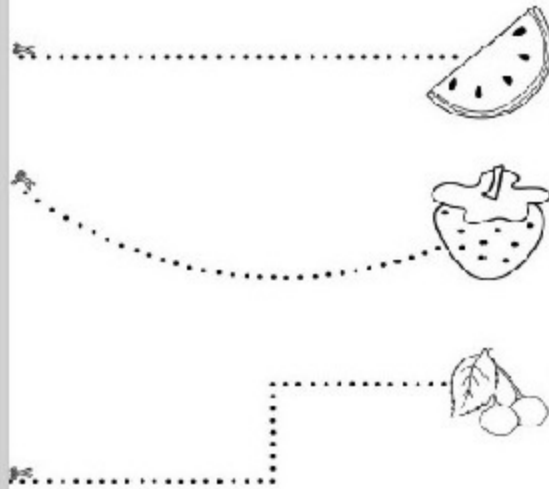

Повежи бројеве. Обој.

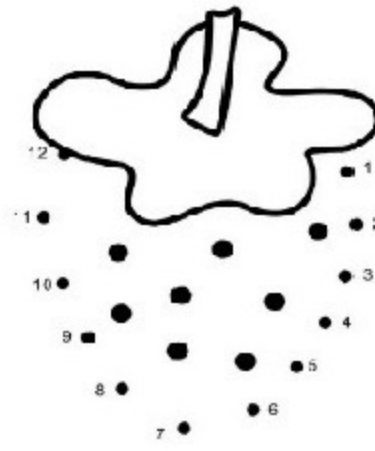

Преброј га калниш број

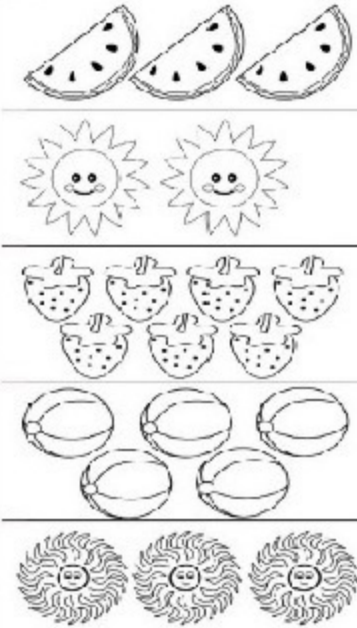

Напиши број који је испред и иза заданог броја.

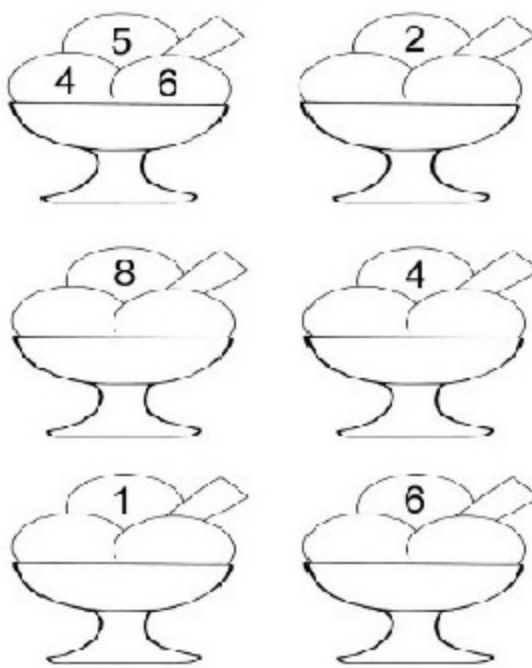

Повежи по тачкицама...

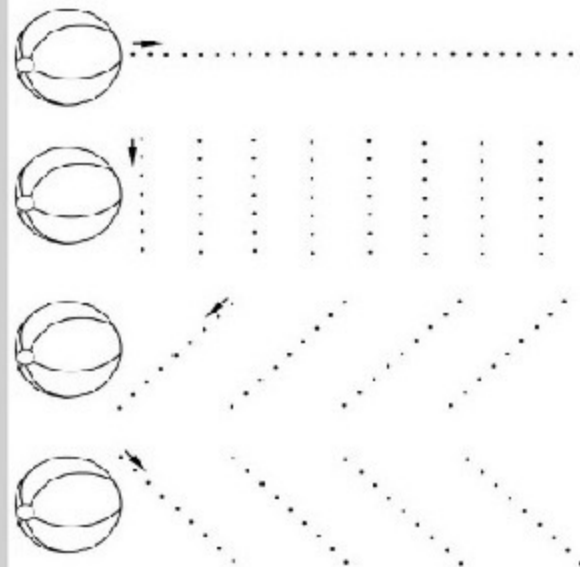

Напиши бројеве који недостају.

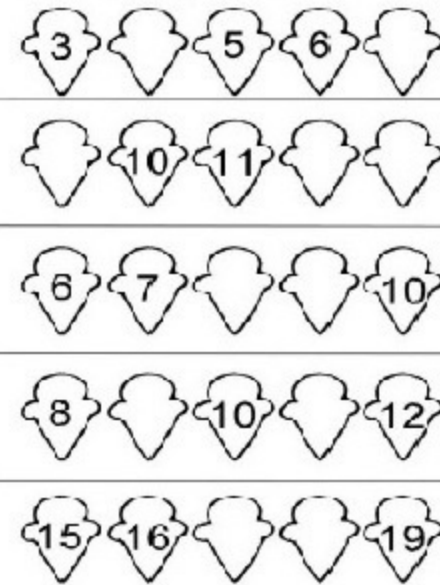

Настави као што је започето.

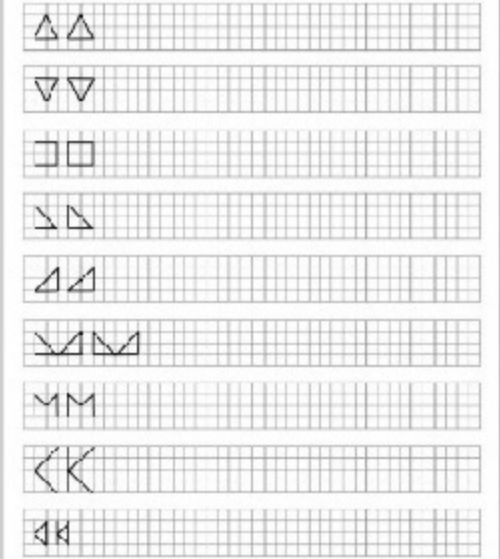

Повежи сенку са њеним предметом.

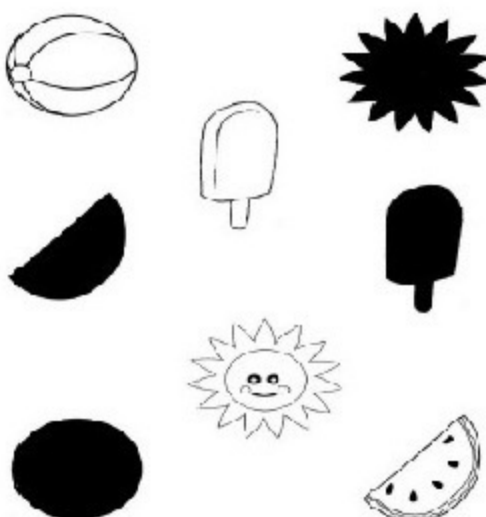

Повежи тачке за сваки облик. Обој слику која је у троуглу.

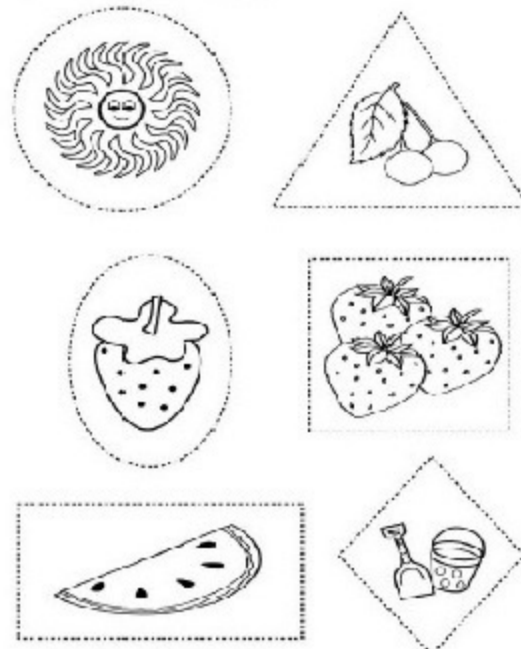

Настави као што је започето.

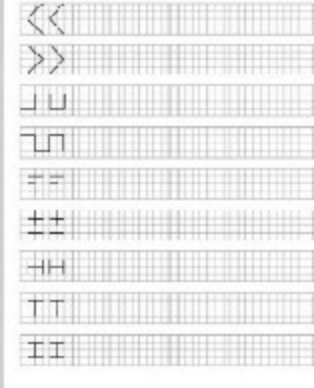

Настави као што је започето.



Настави као што је започето.

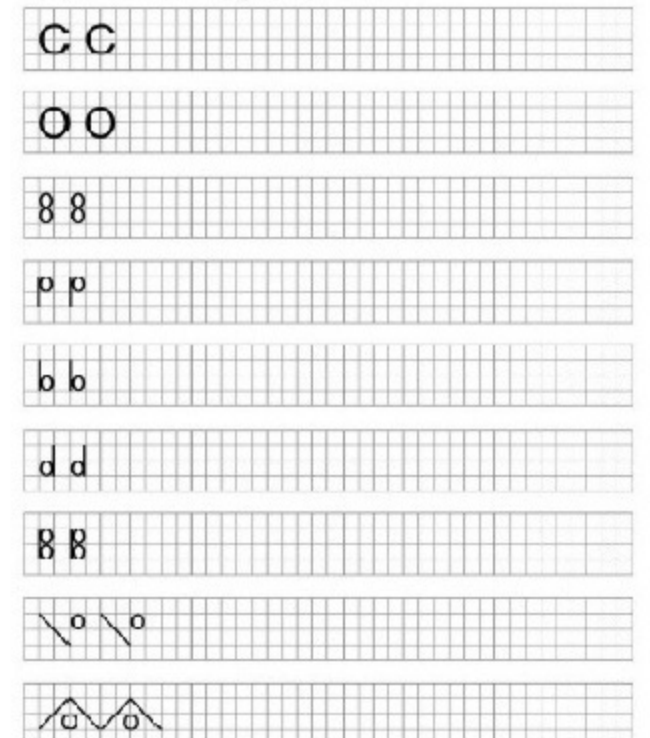

Летња графомоторика

Обој, исеци и порђај слике од највеће до најмање.

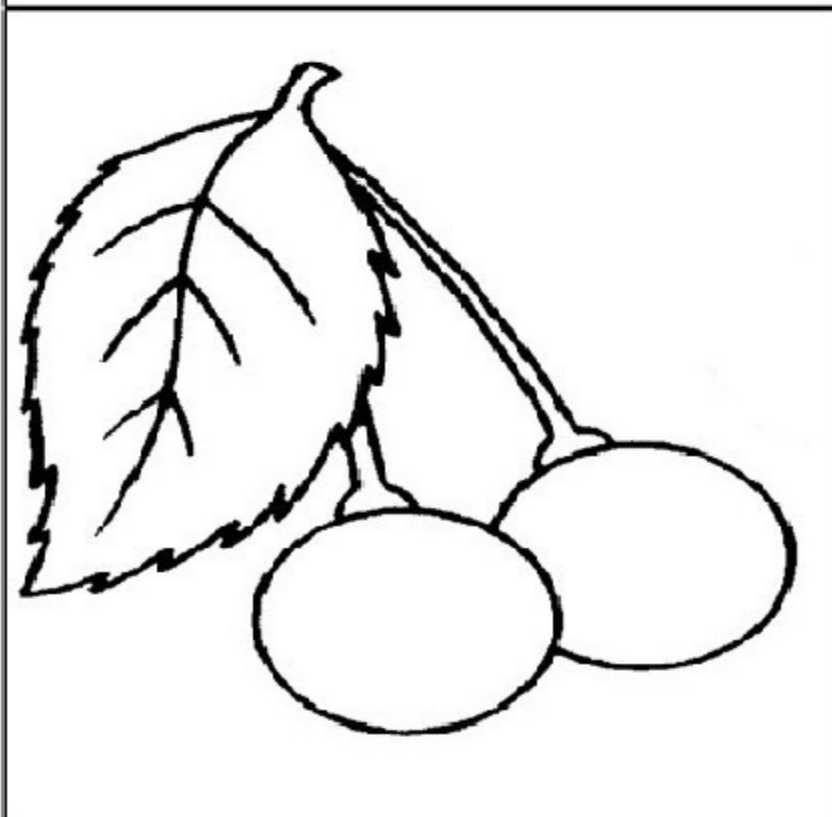
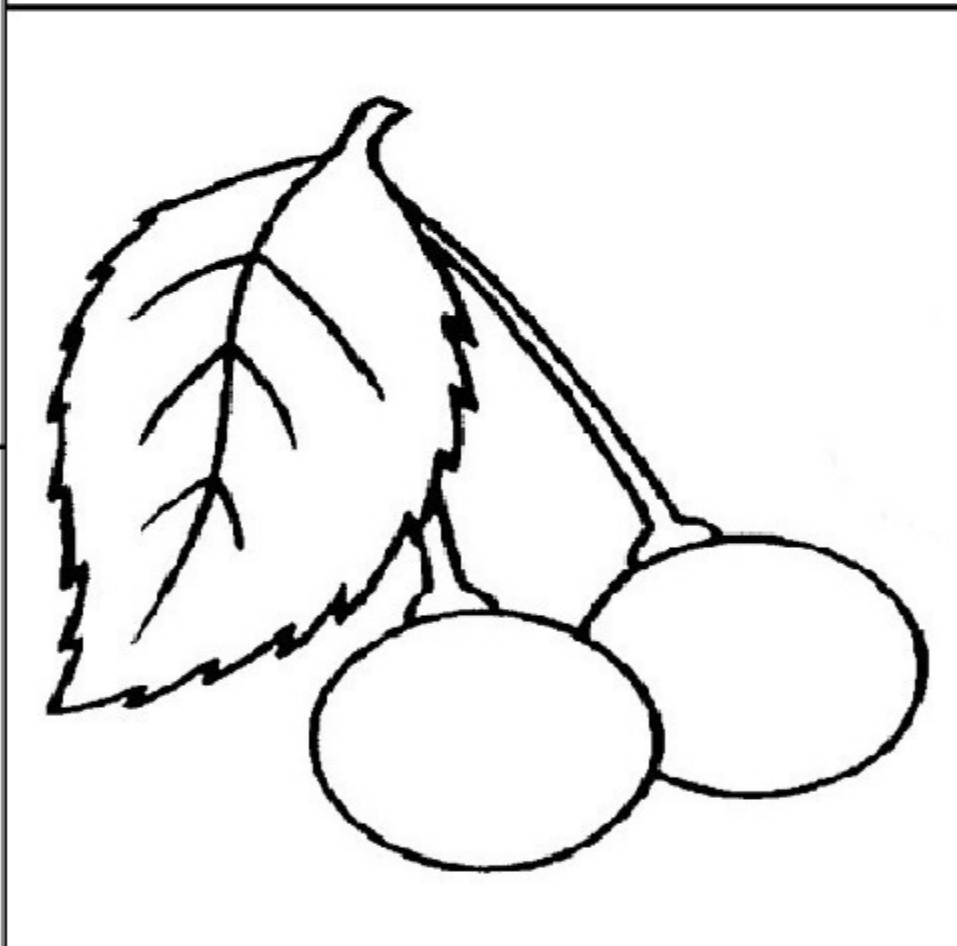
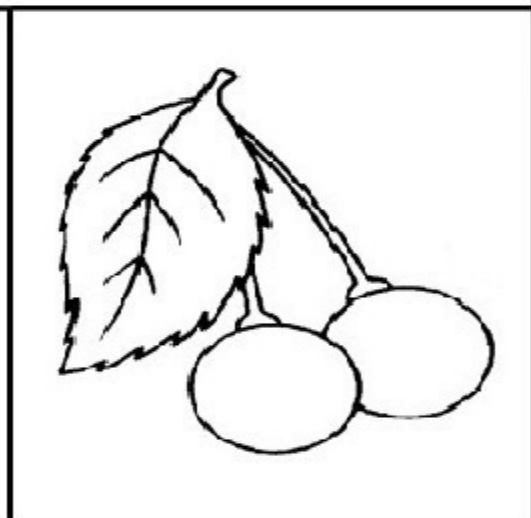
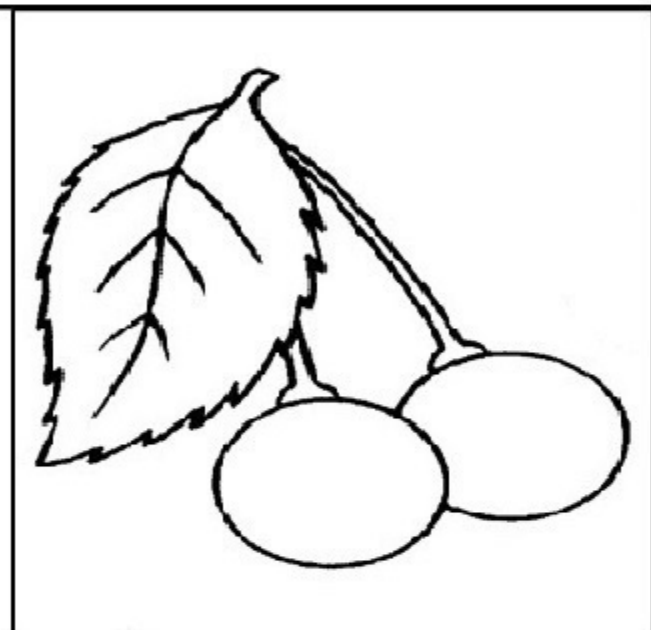
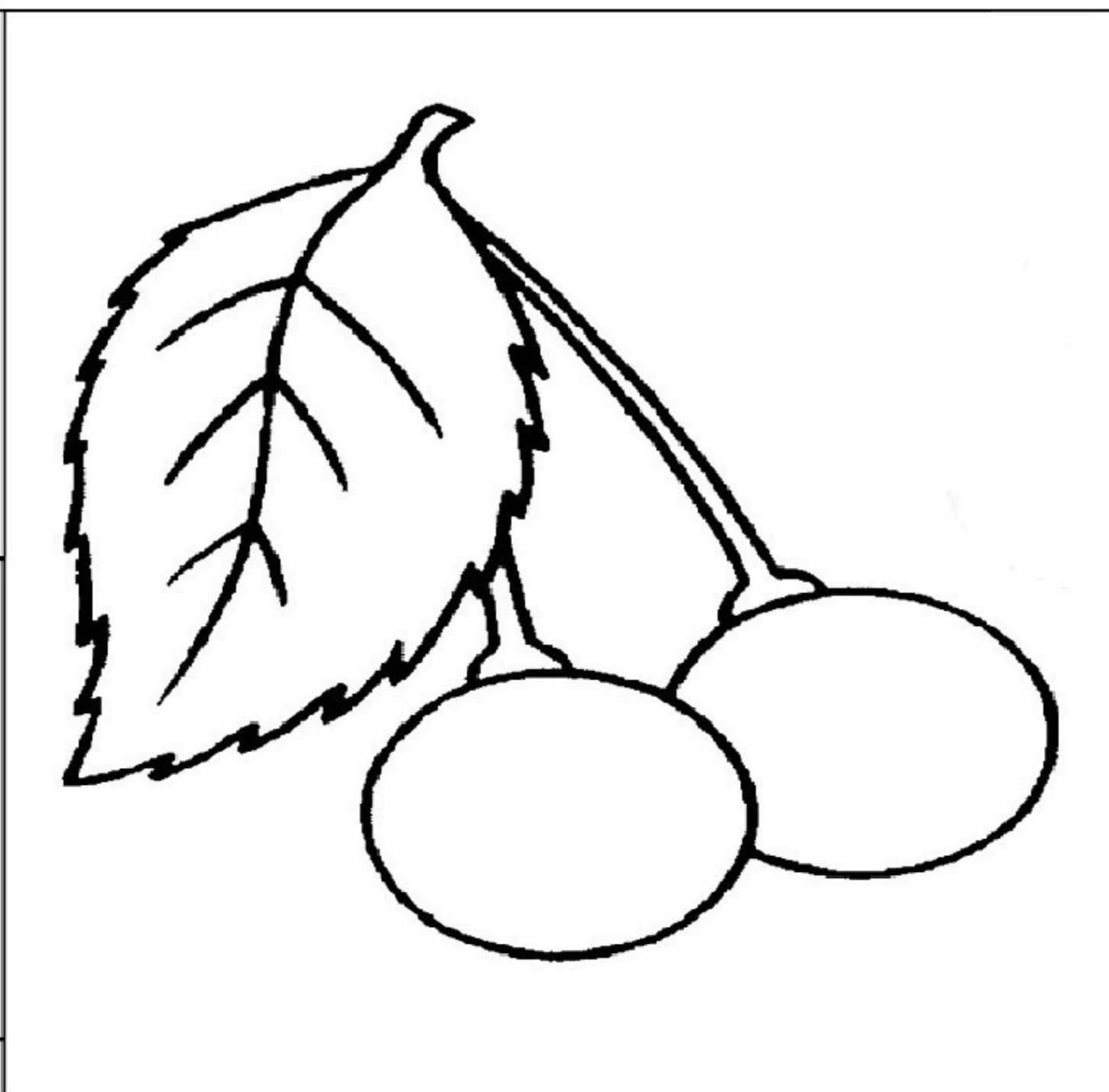
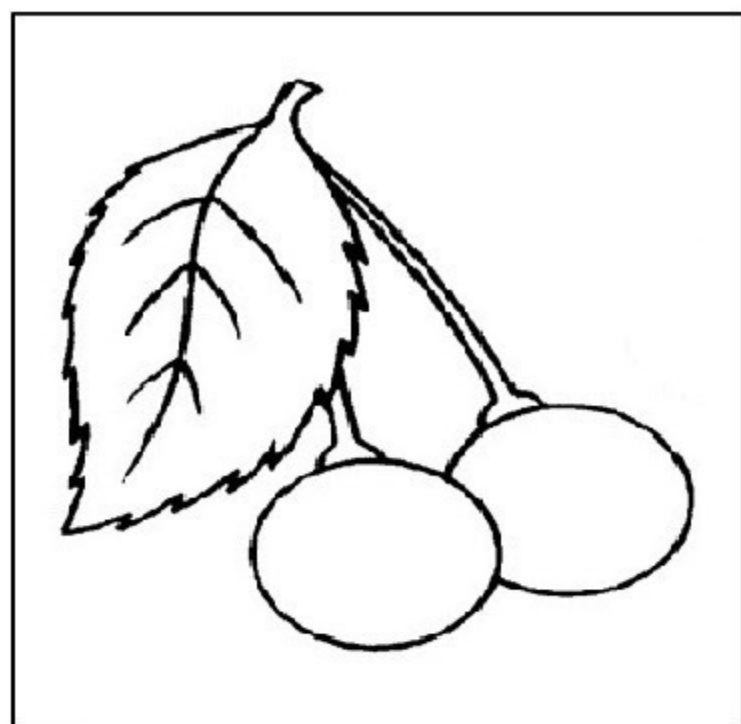

Обој различито!

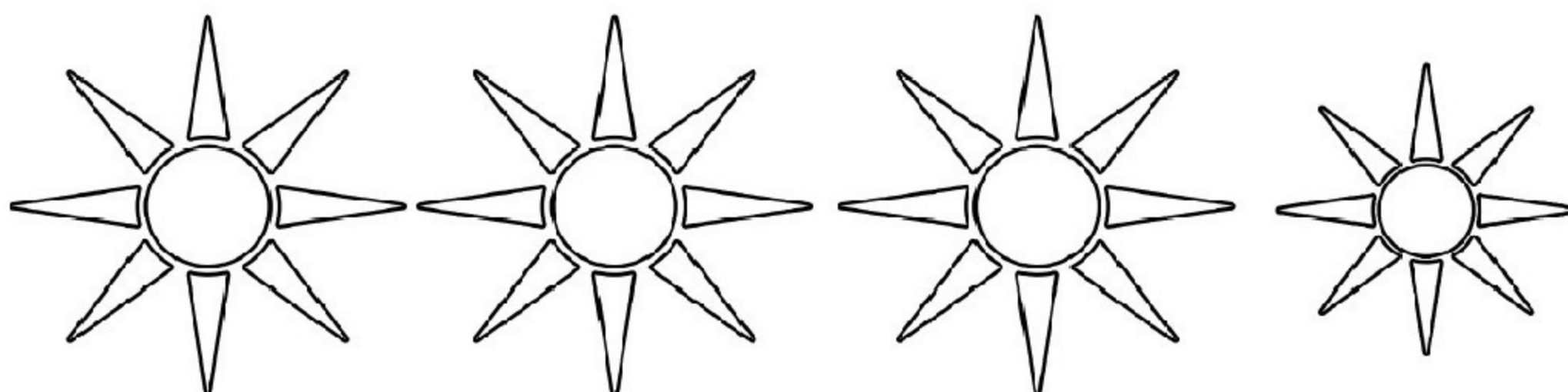
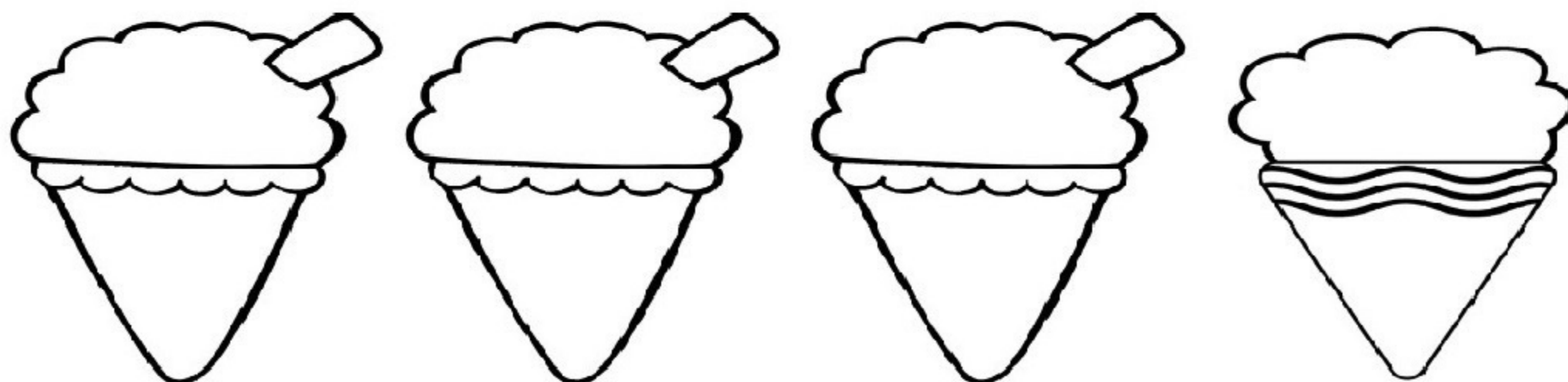
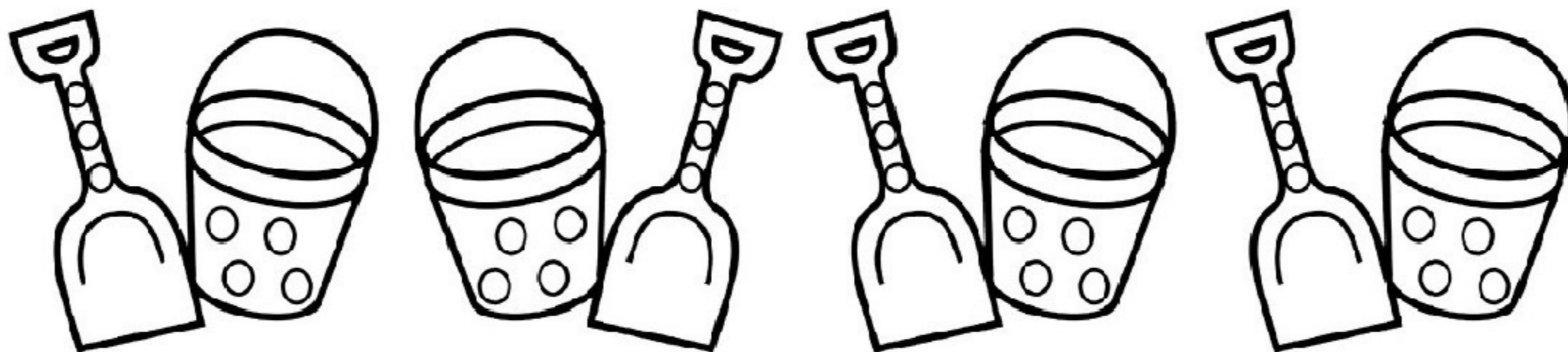
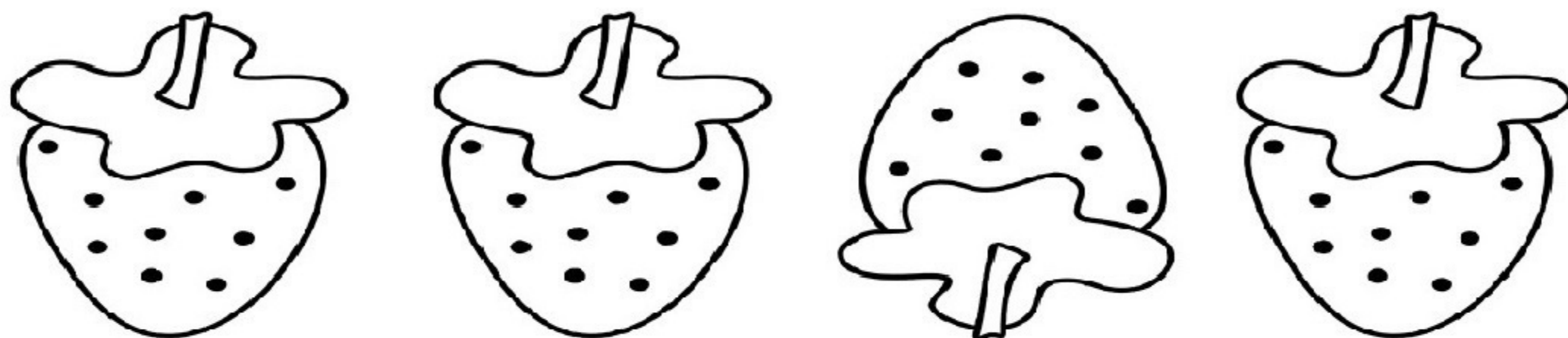
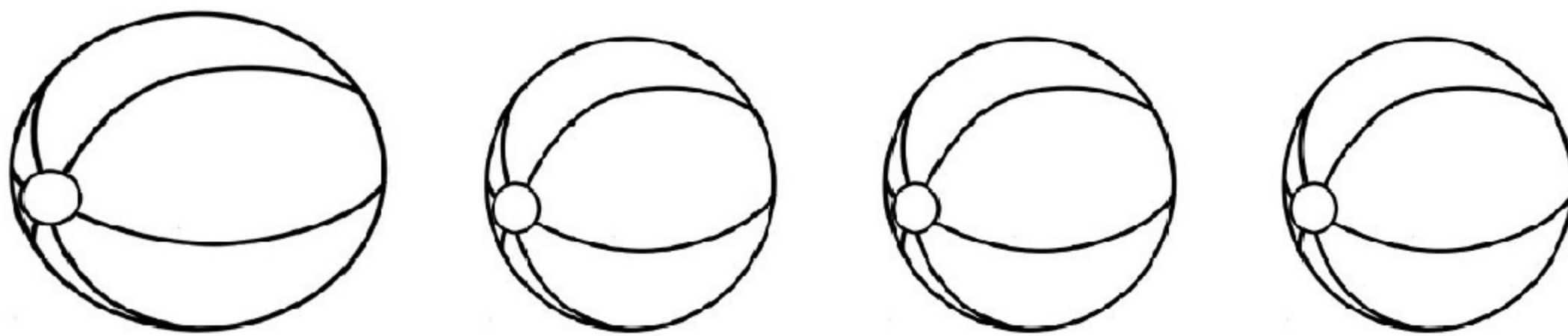

Обој како је започето!

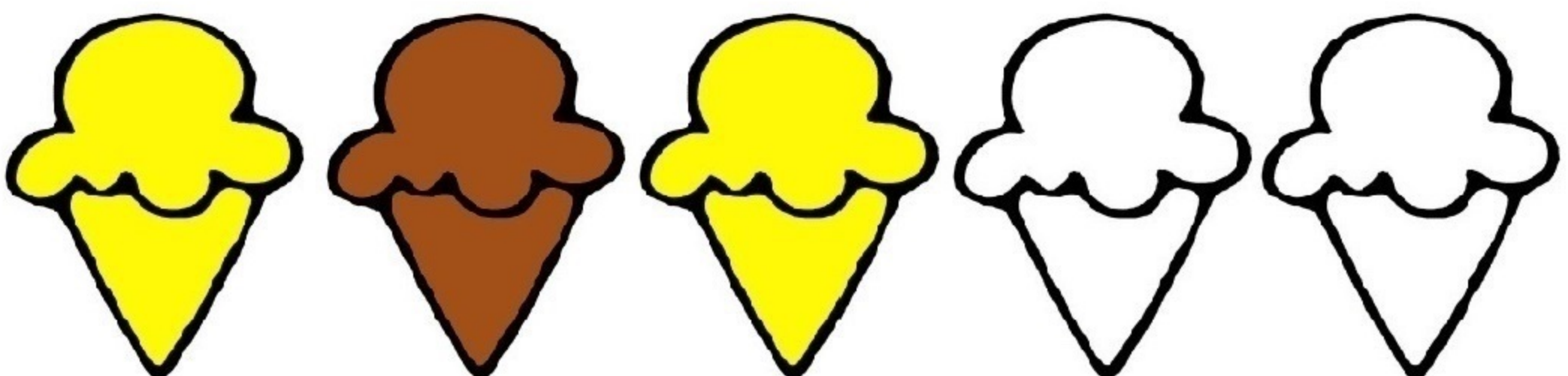
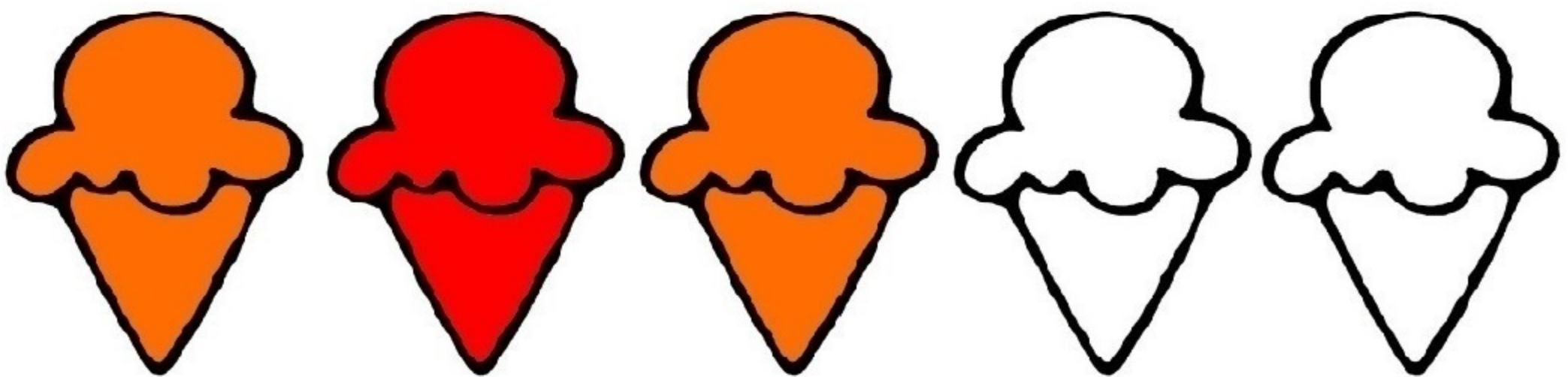
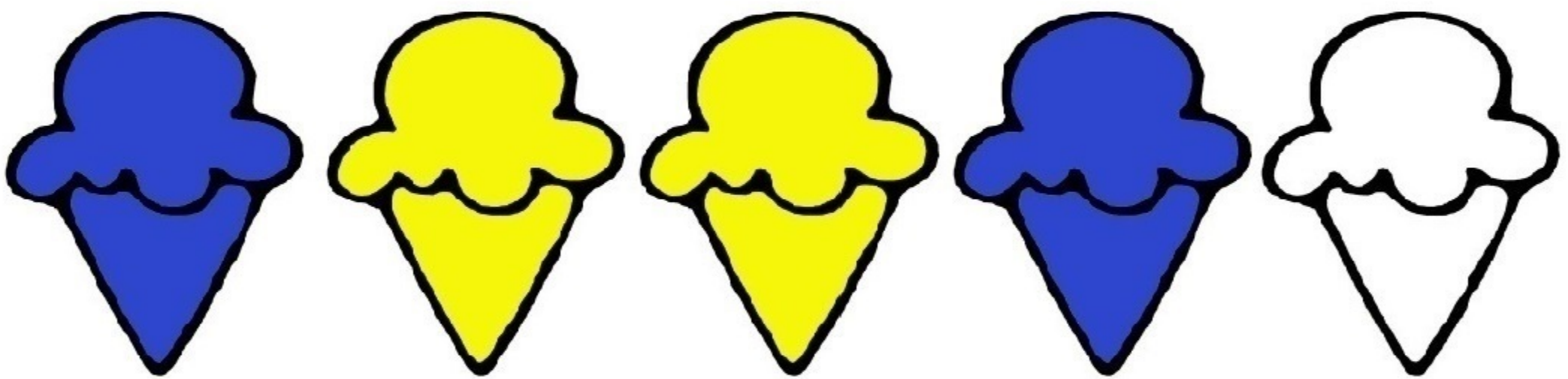
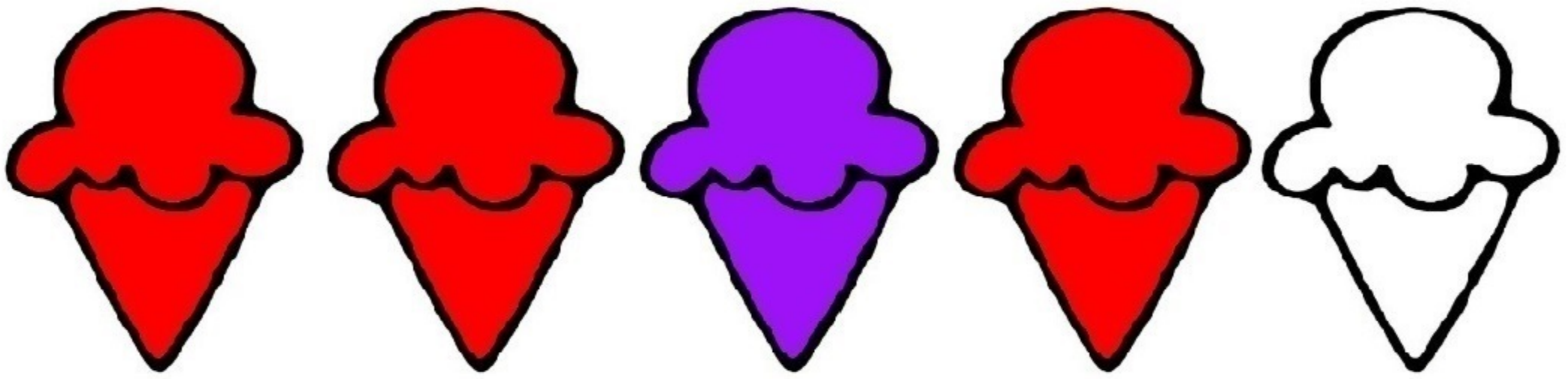
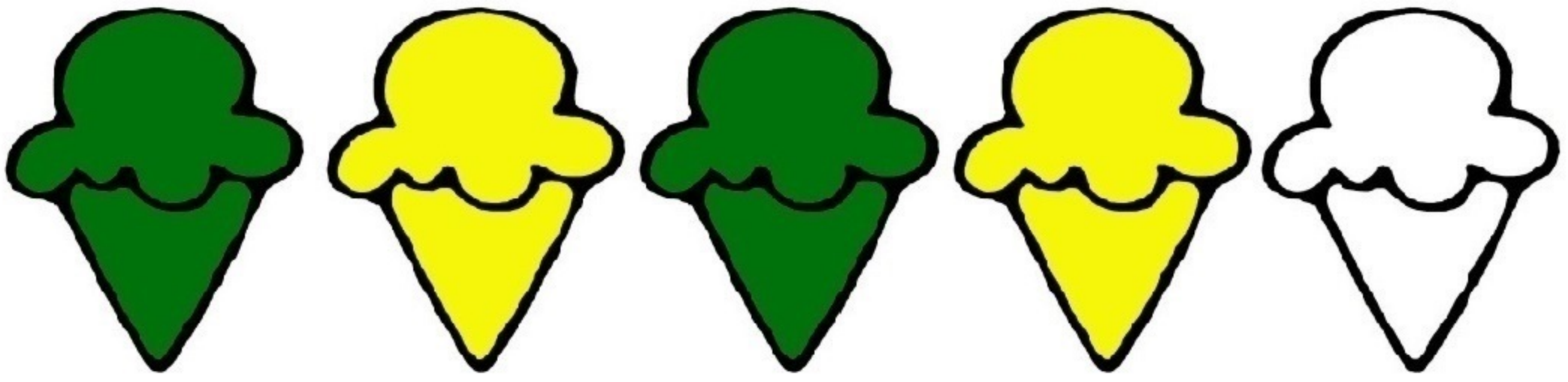

Повежи сенку са њеним предметом.

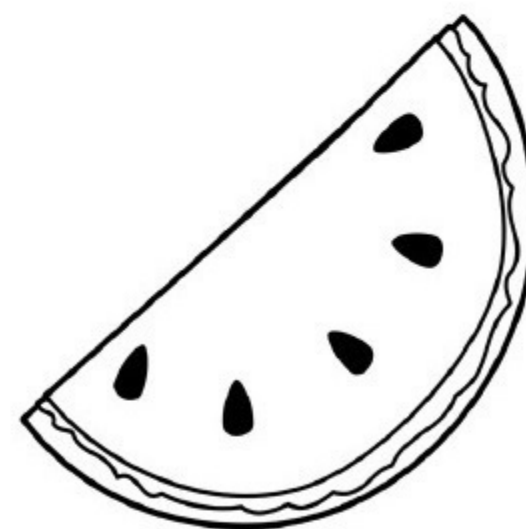
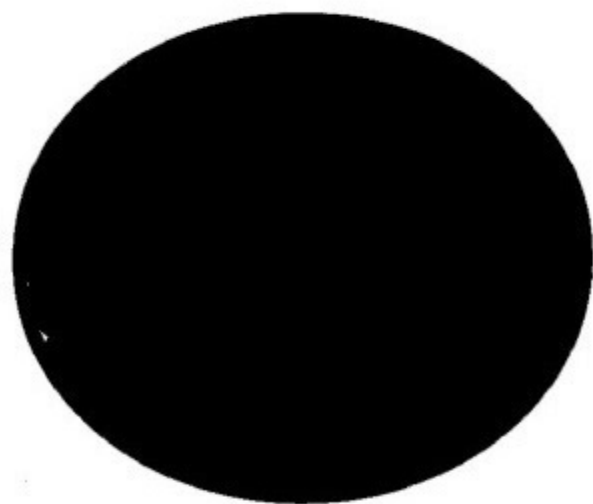
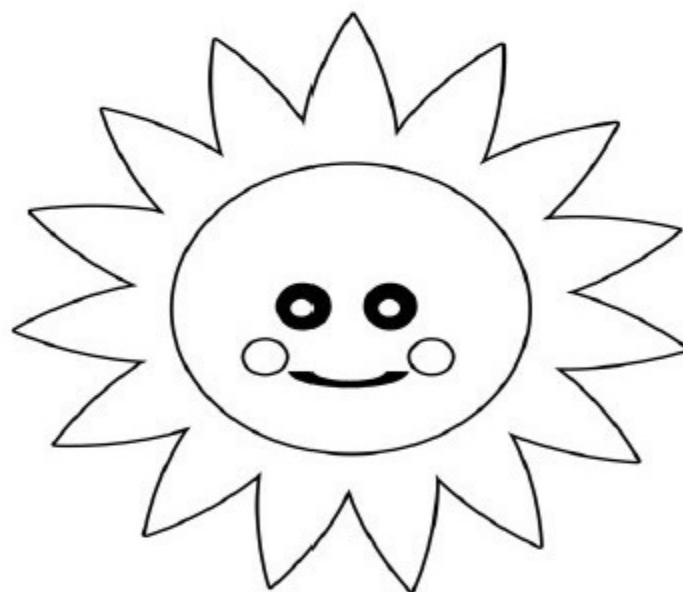
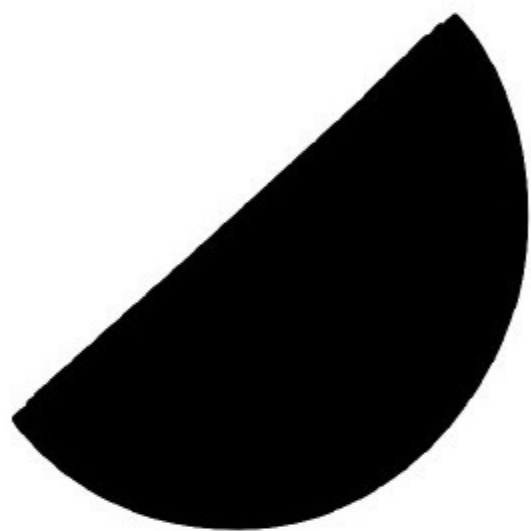
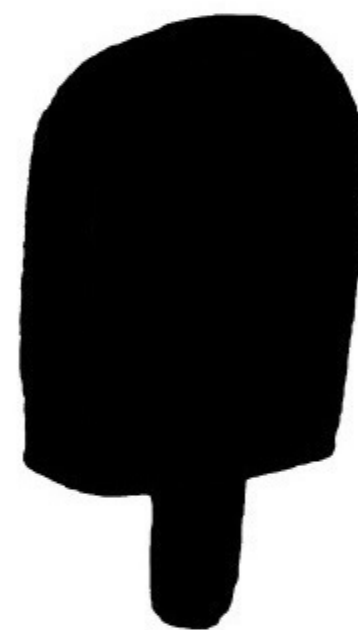
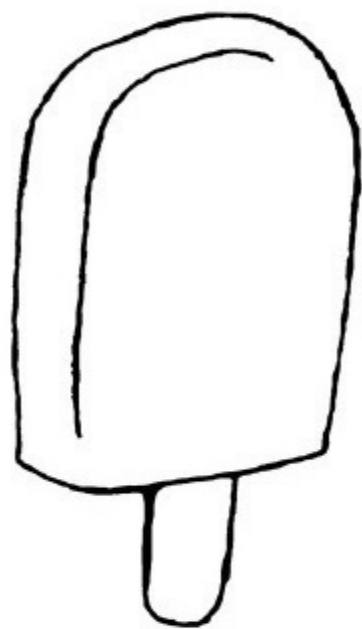
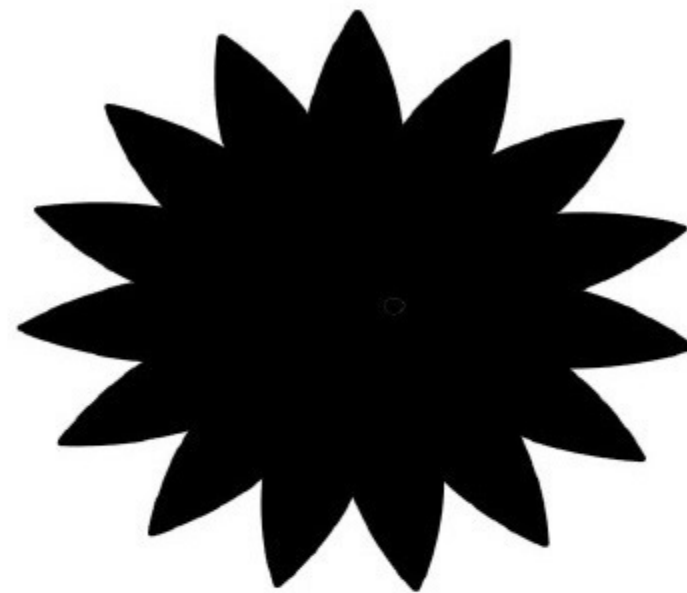
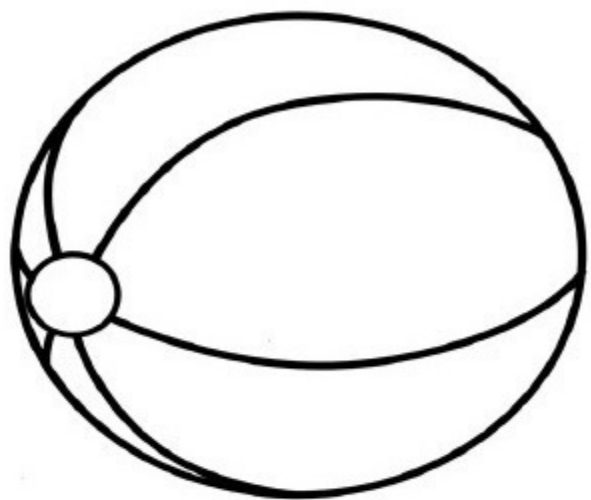

Повежи тачке за сваки облик.
Обој слику која је у проуглу.

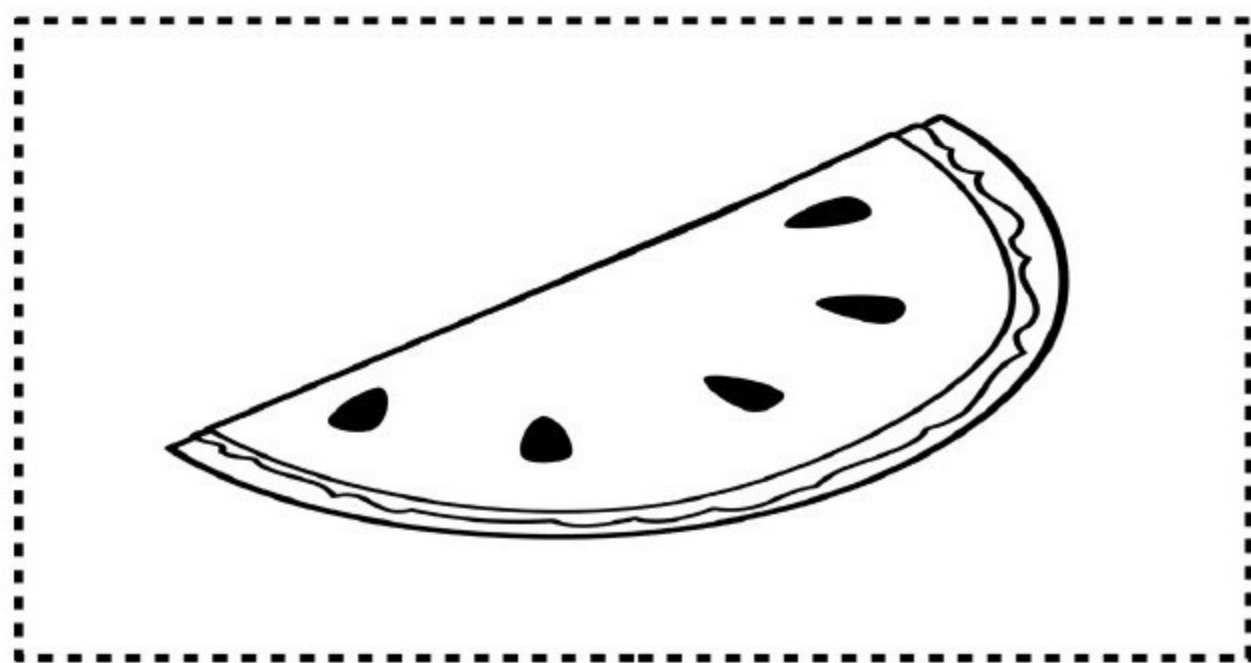
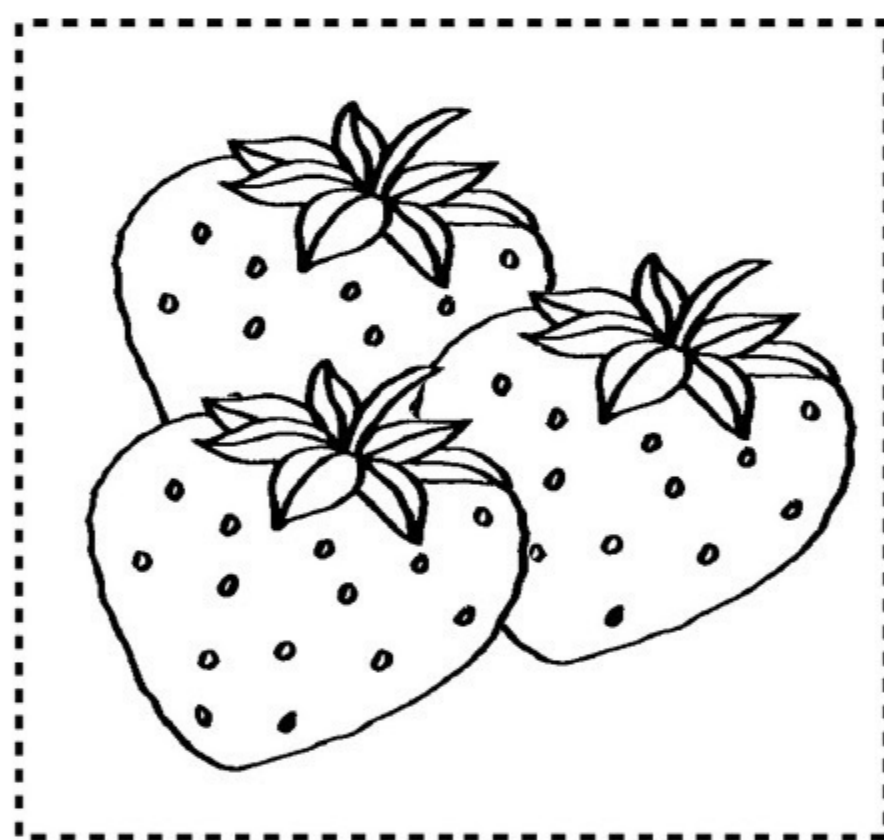
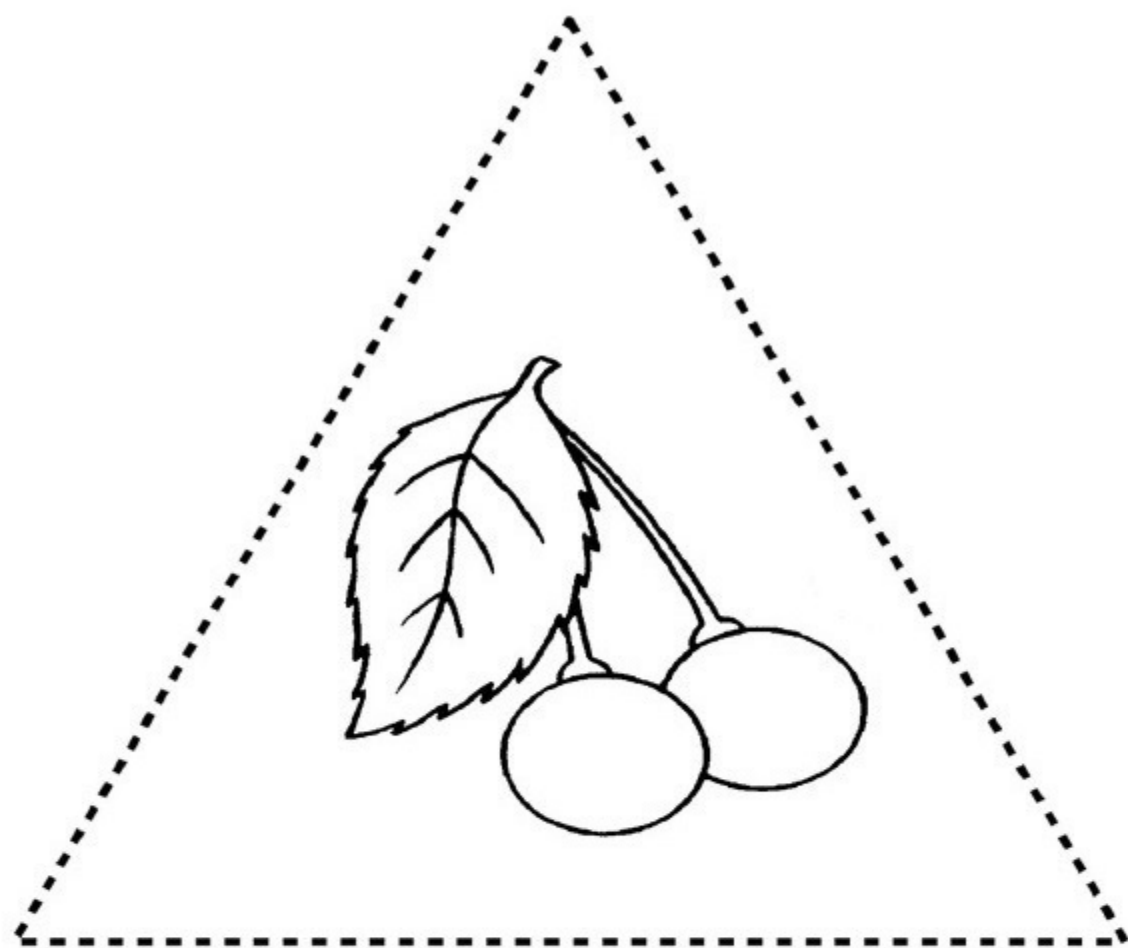
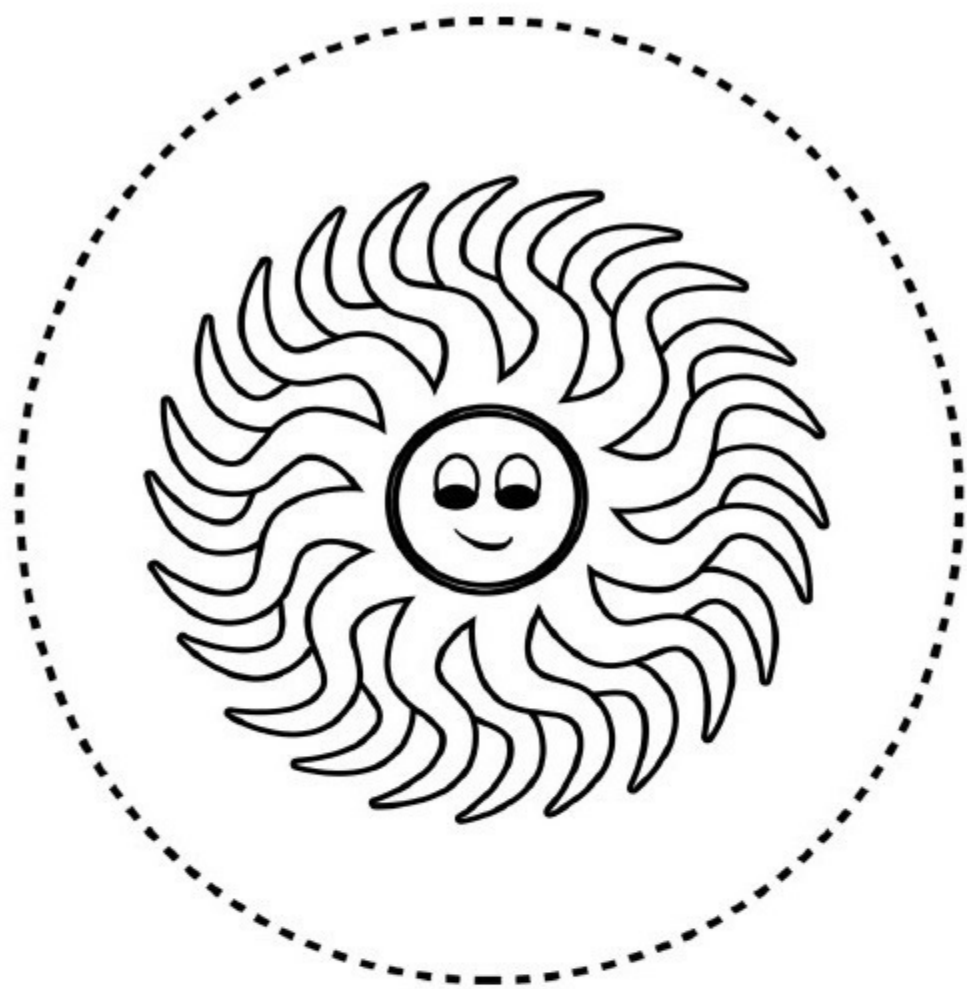

Повежи по тачкицама...

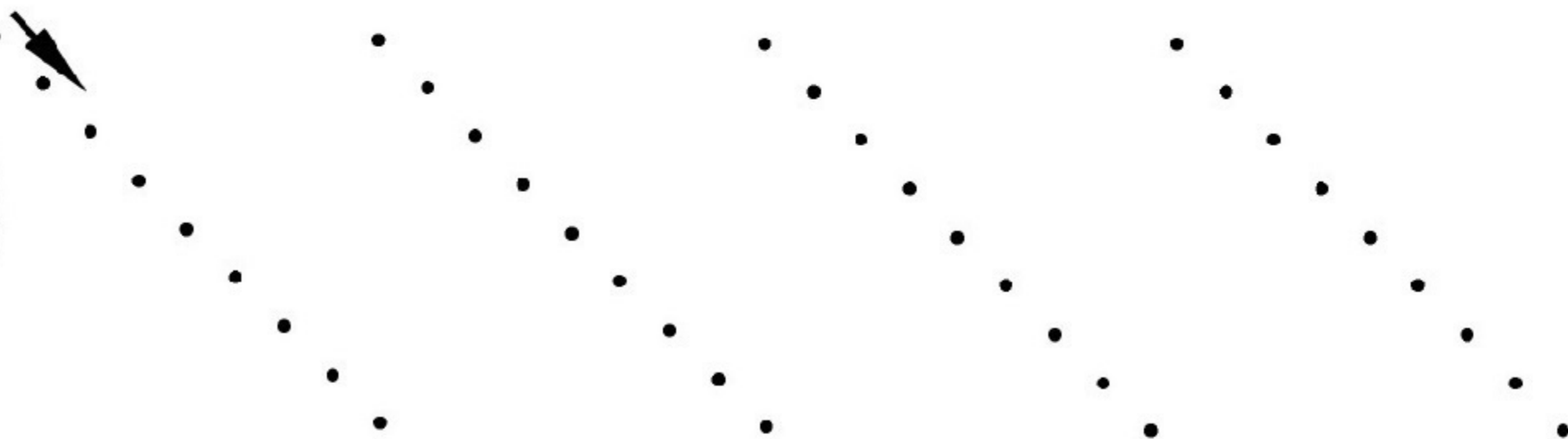
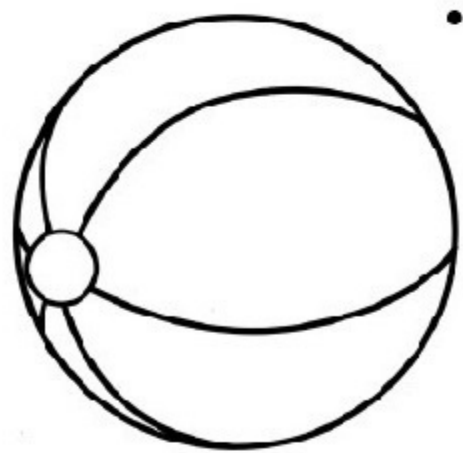
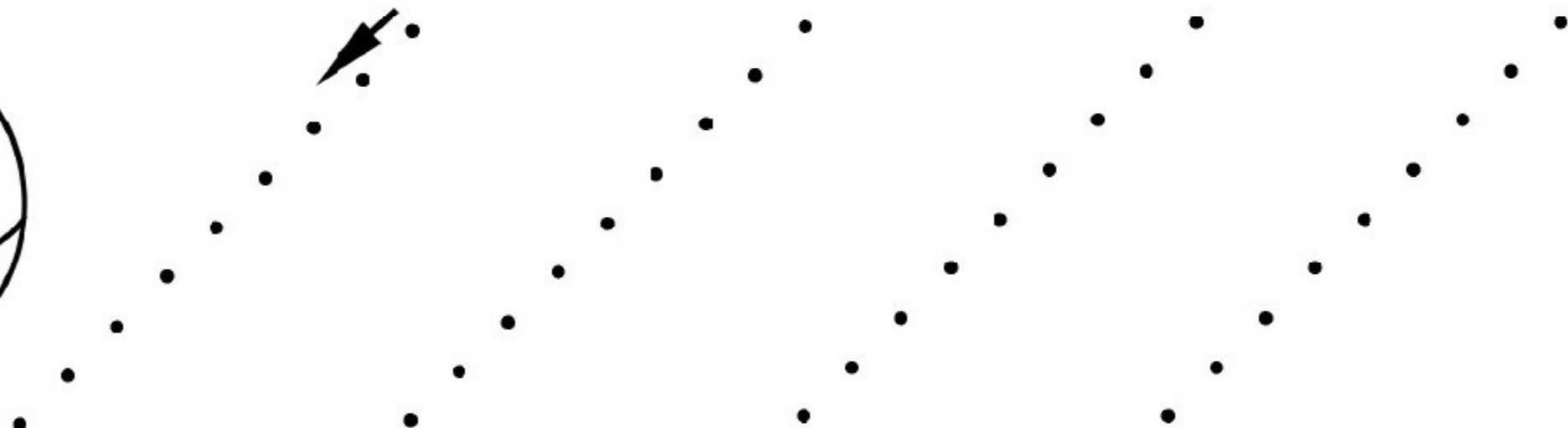
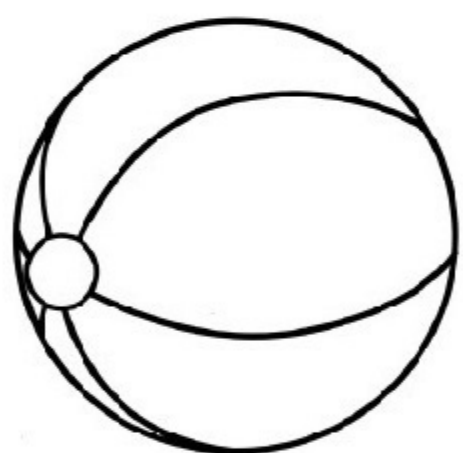
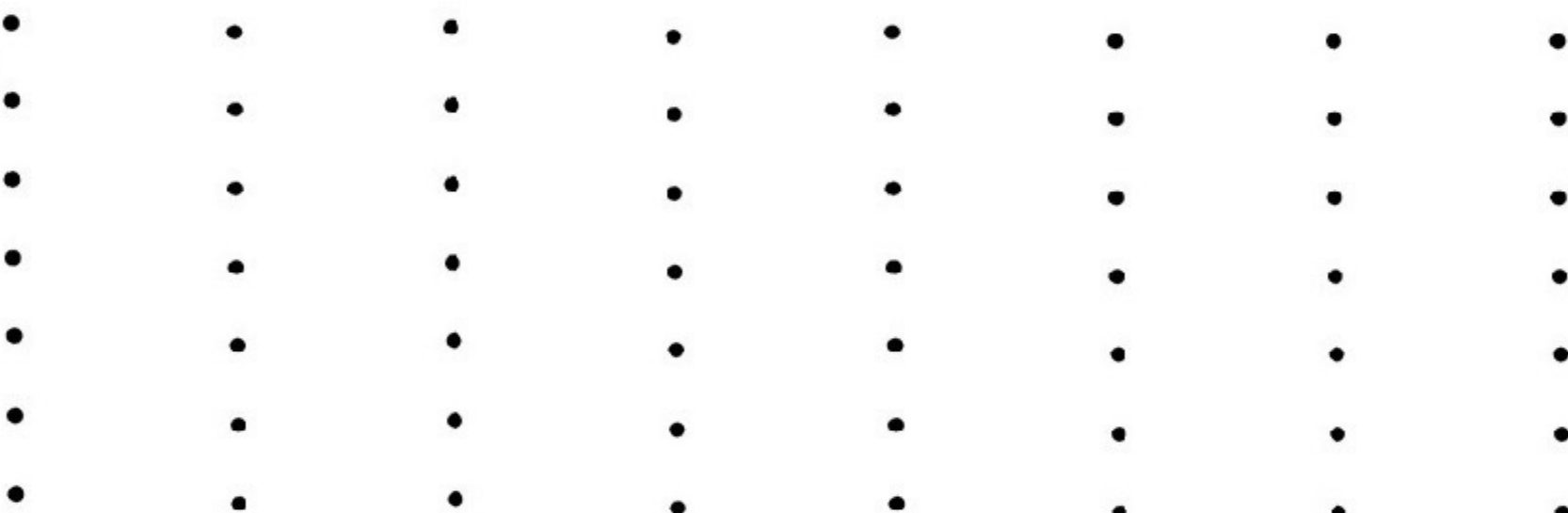
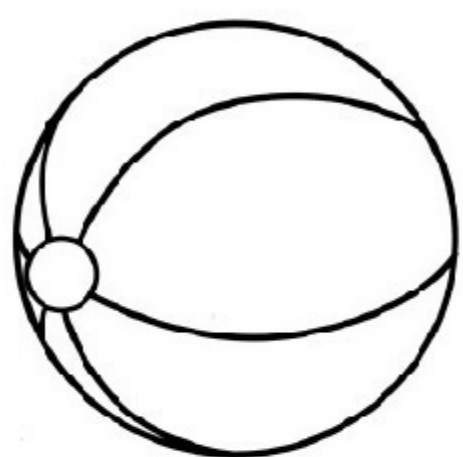
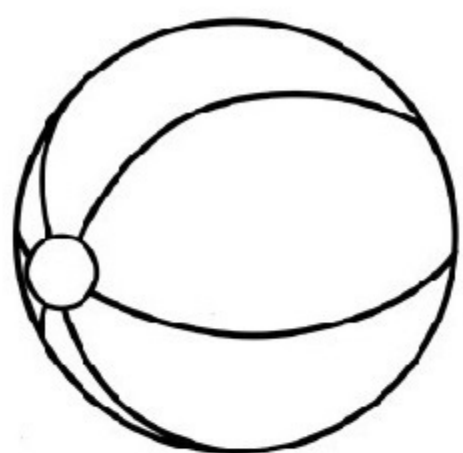

Помози прешњама да стигну до дрвета.

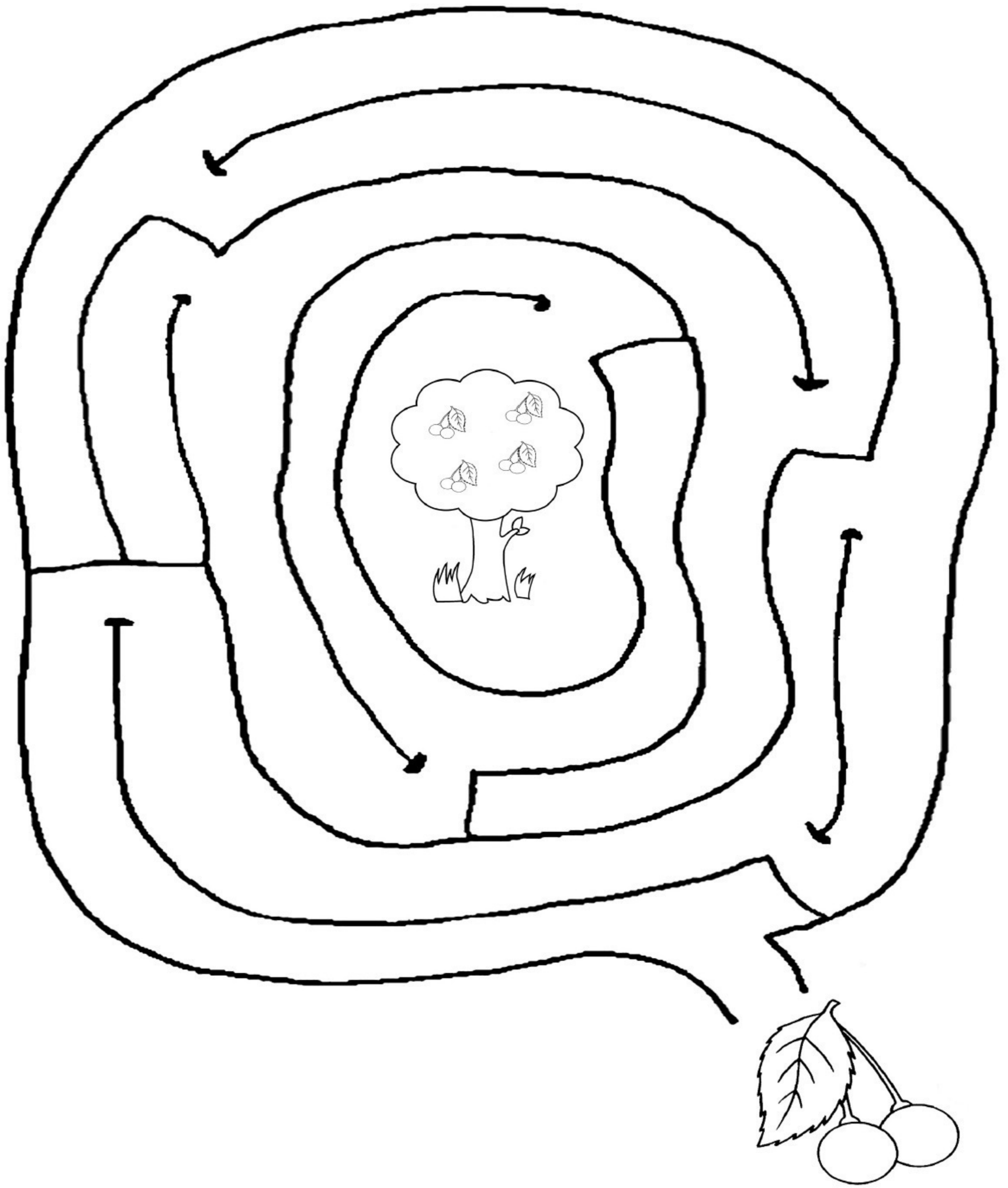

Исеци папир да дођеш до слике.
Прати тачкице.

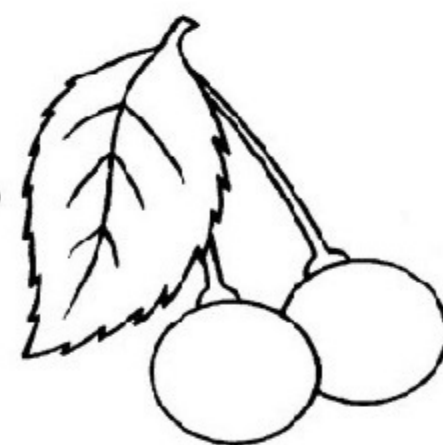
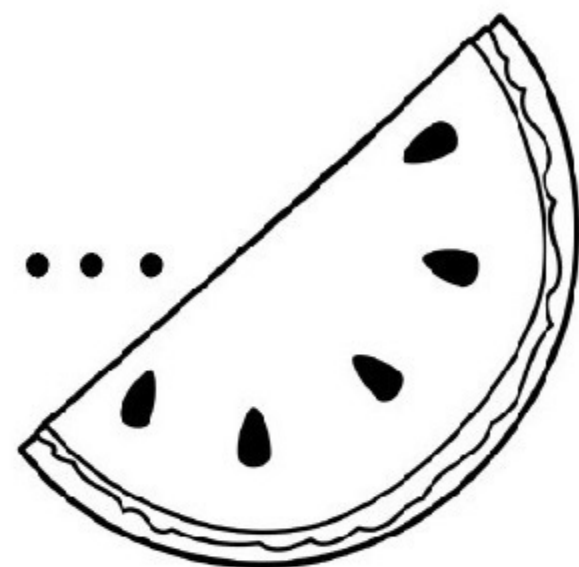

Преброј, па напиши број

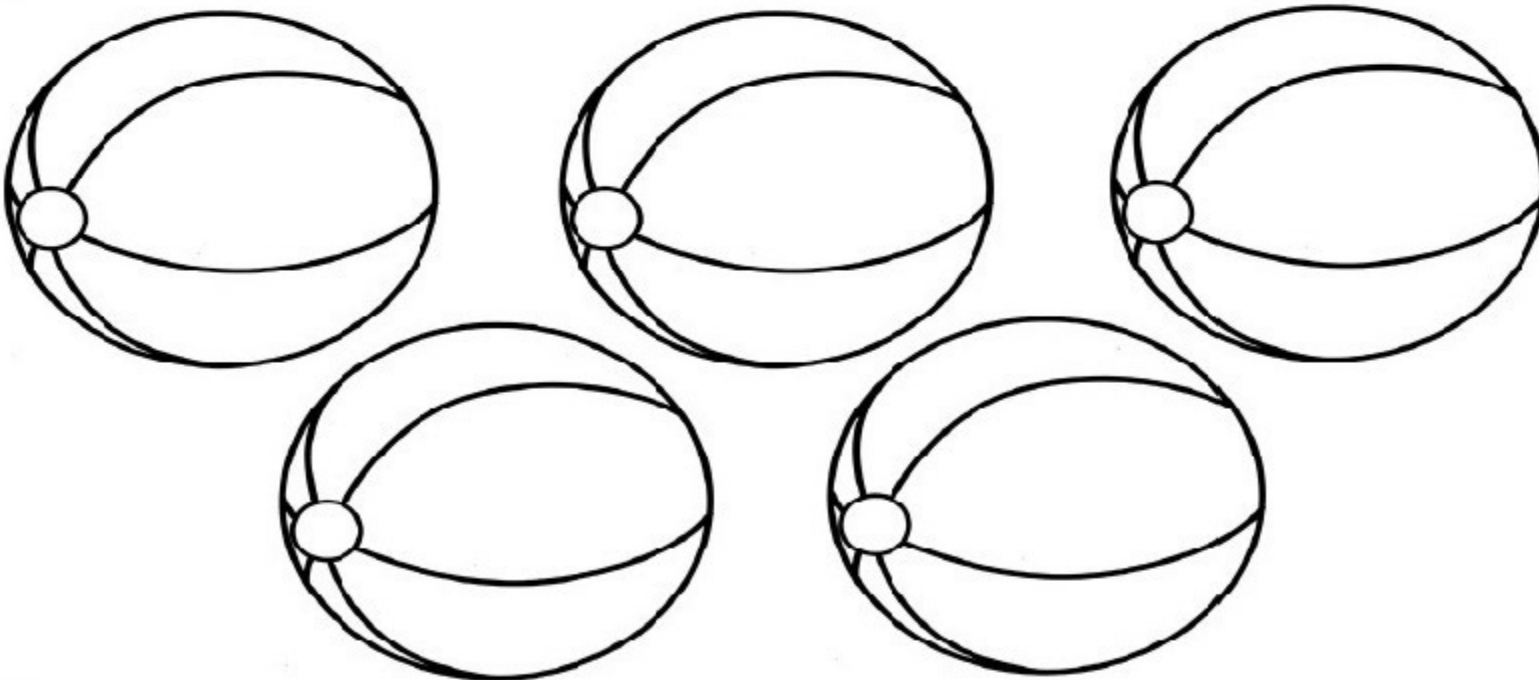
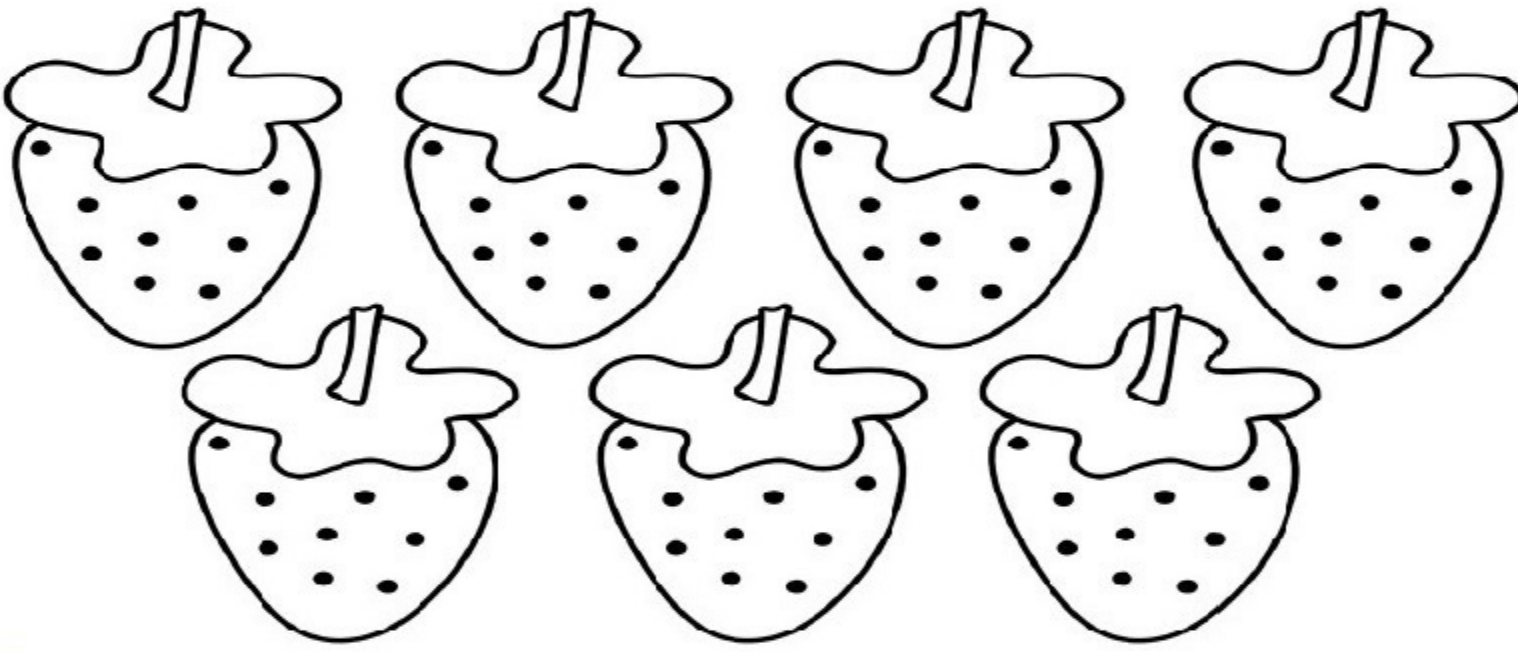
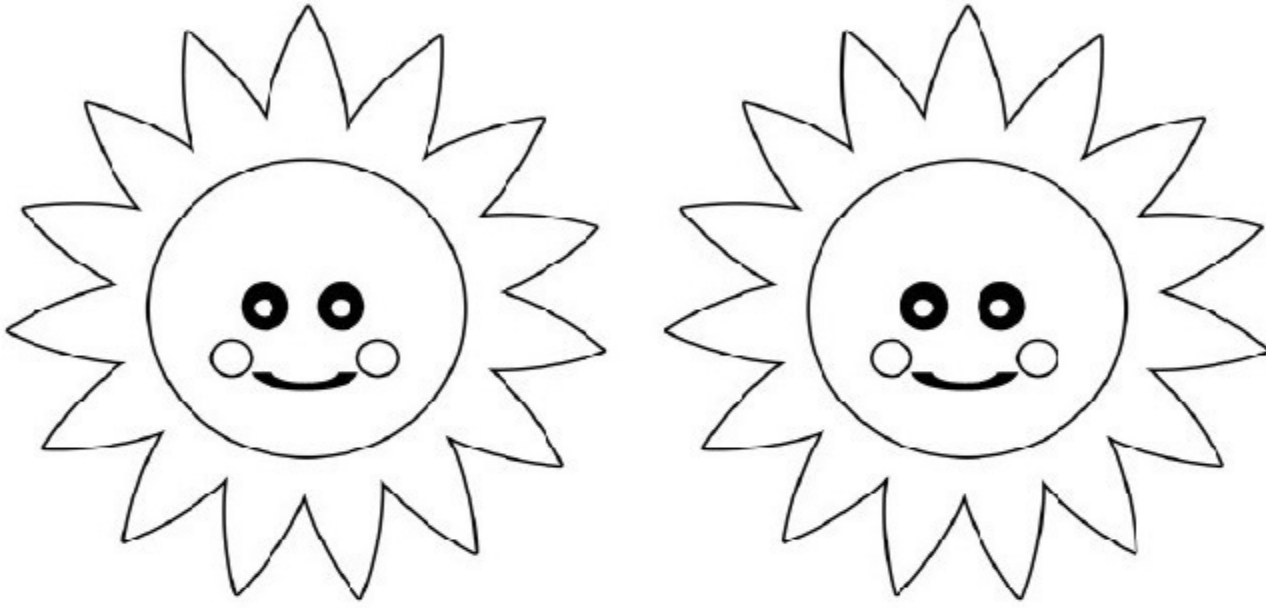
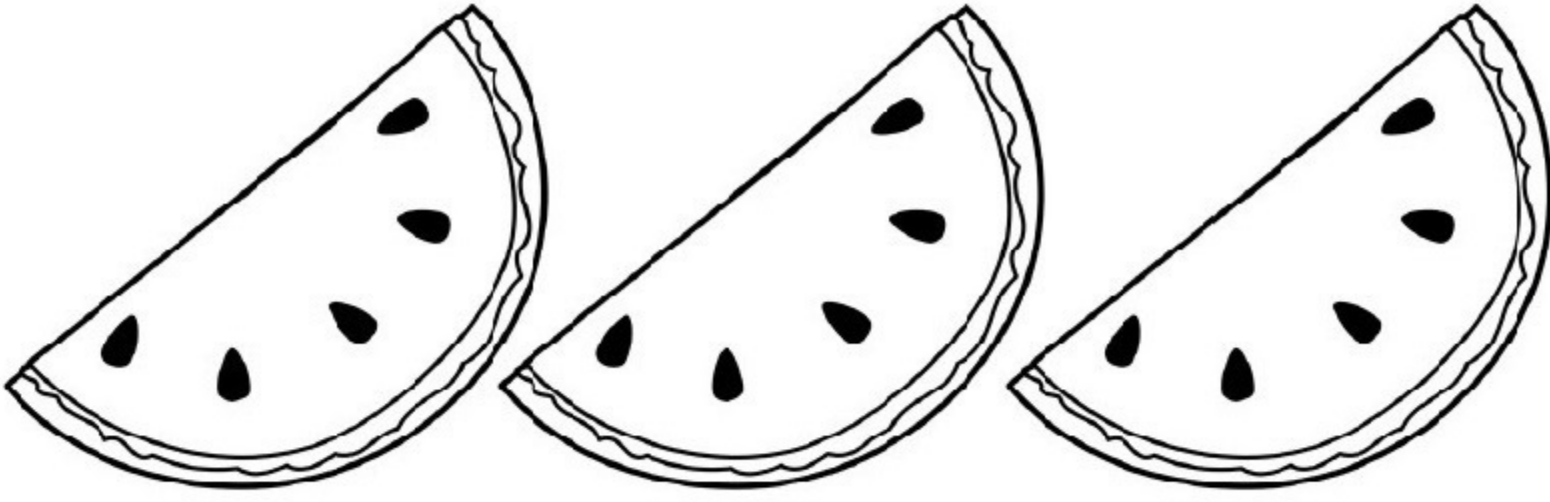

Повежи бројеве.
Обој.

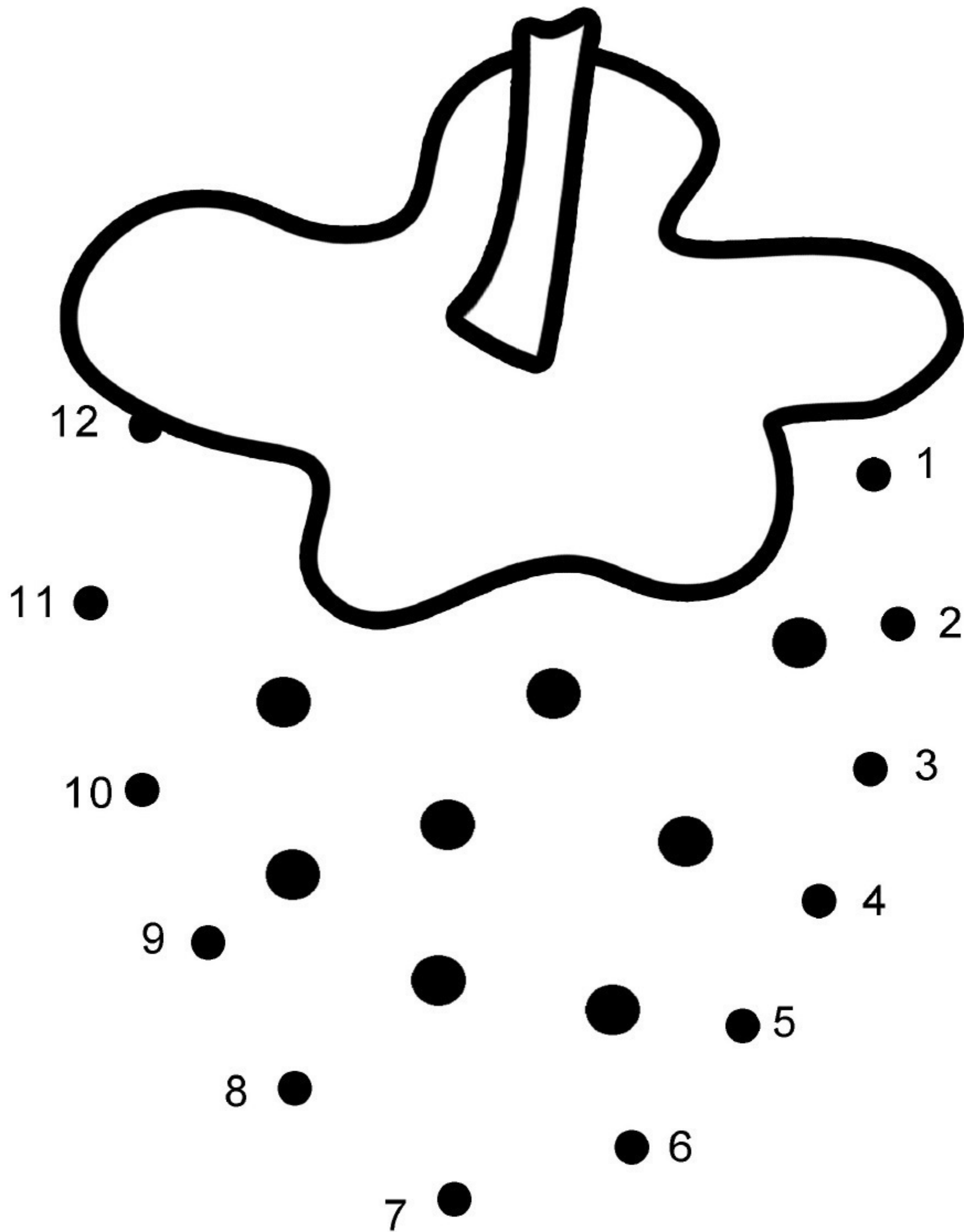

Напиши бројеве који недостају.

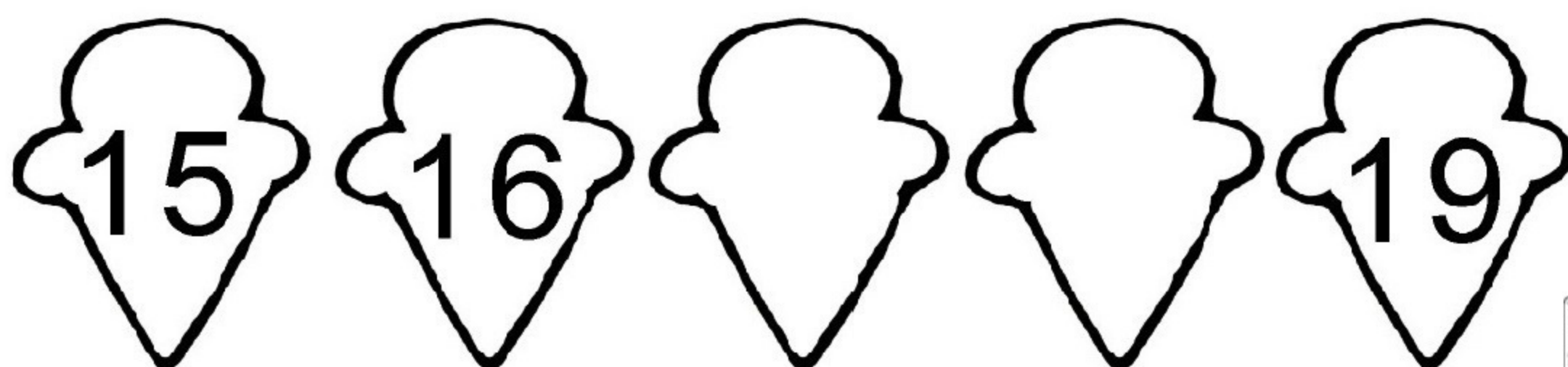
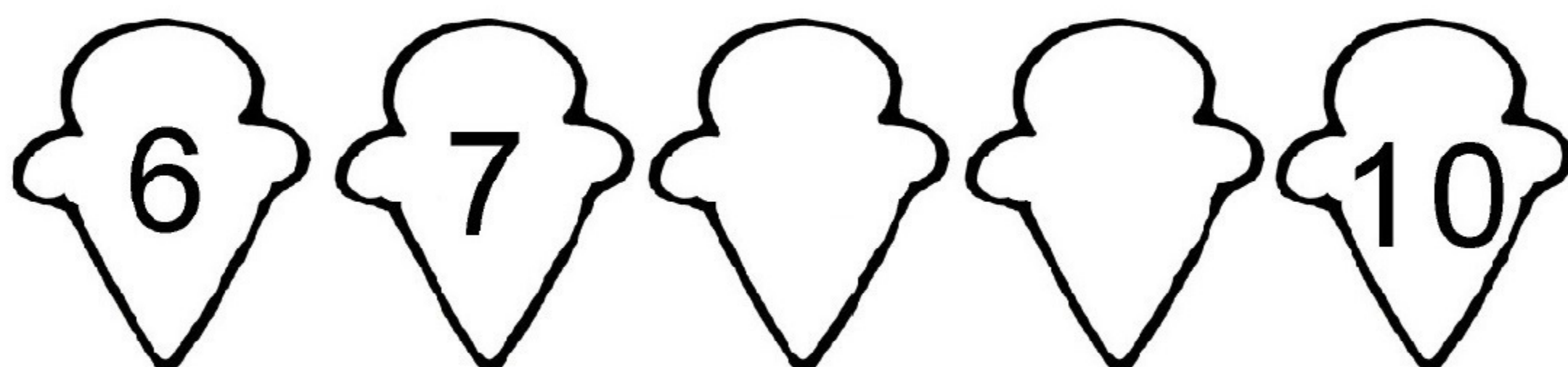

Напиши број који је испред и иза задатог броја.

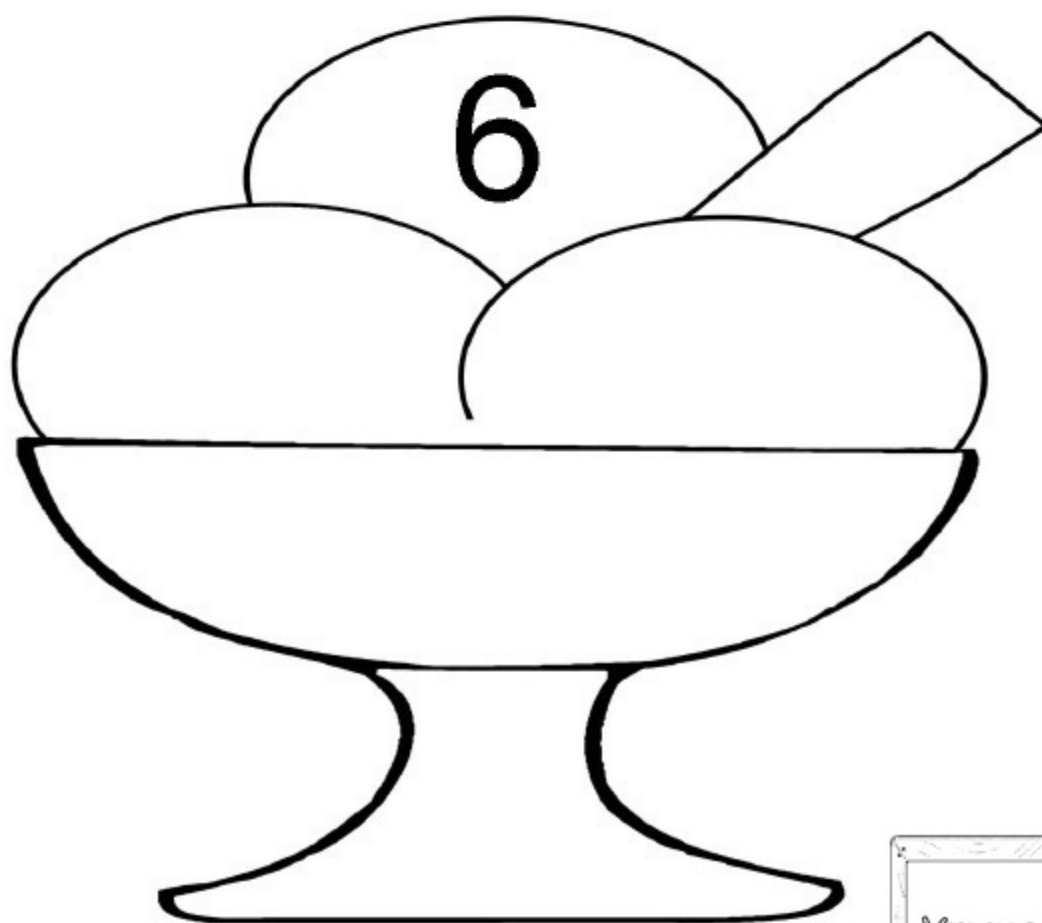
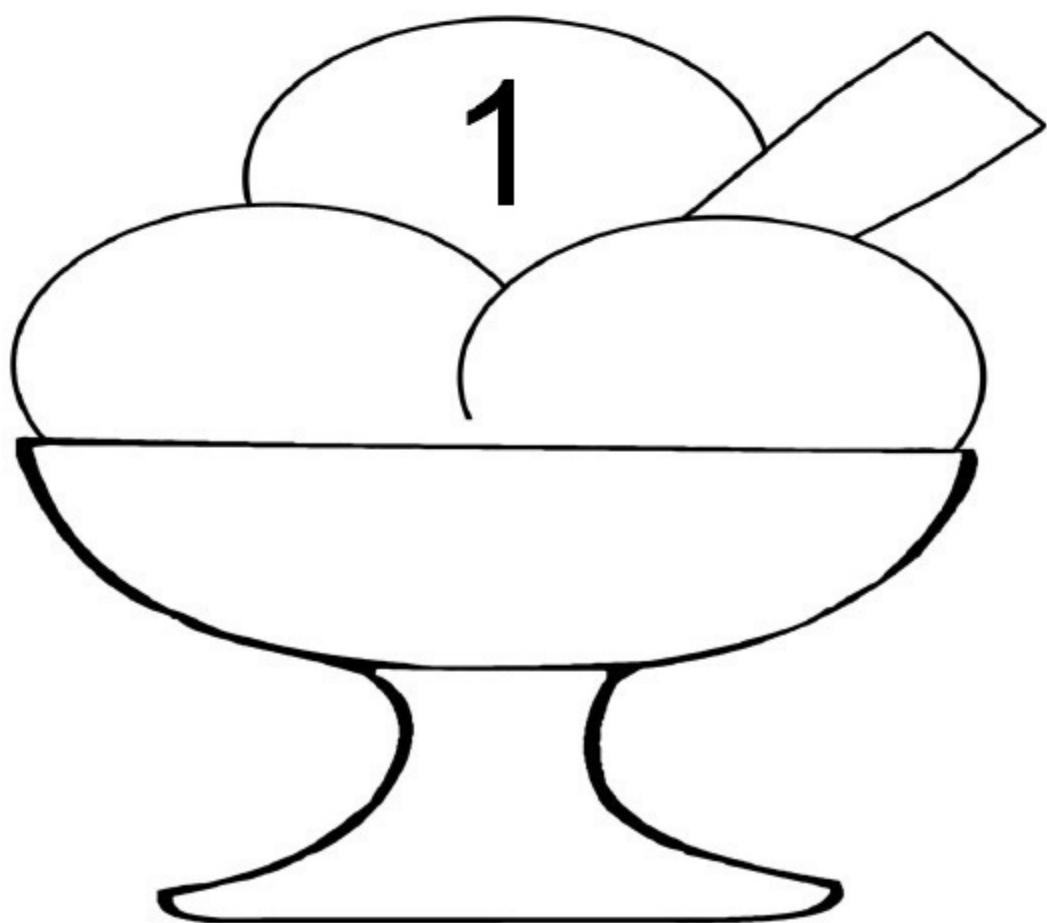
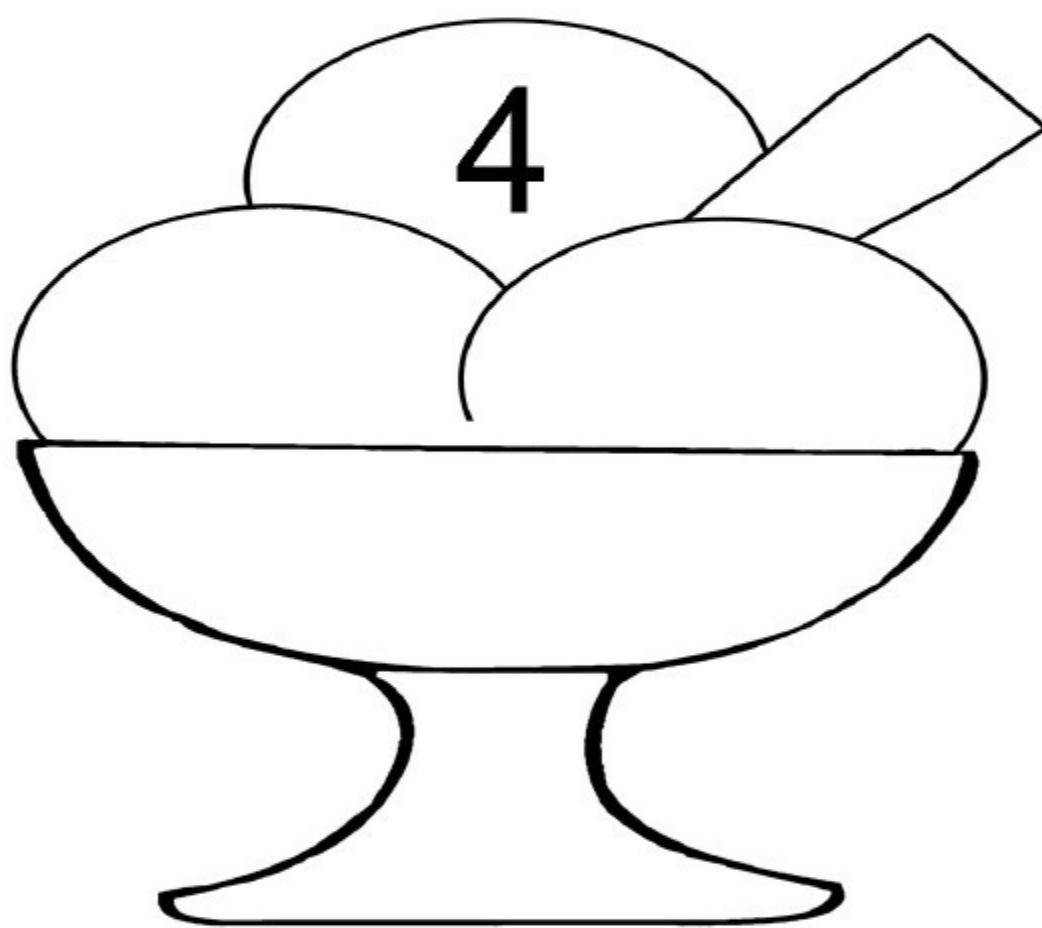
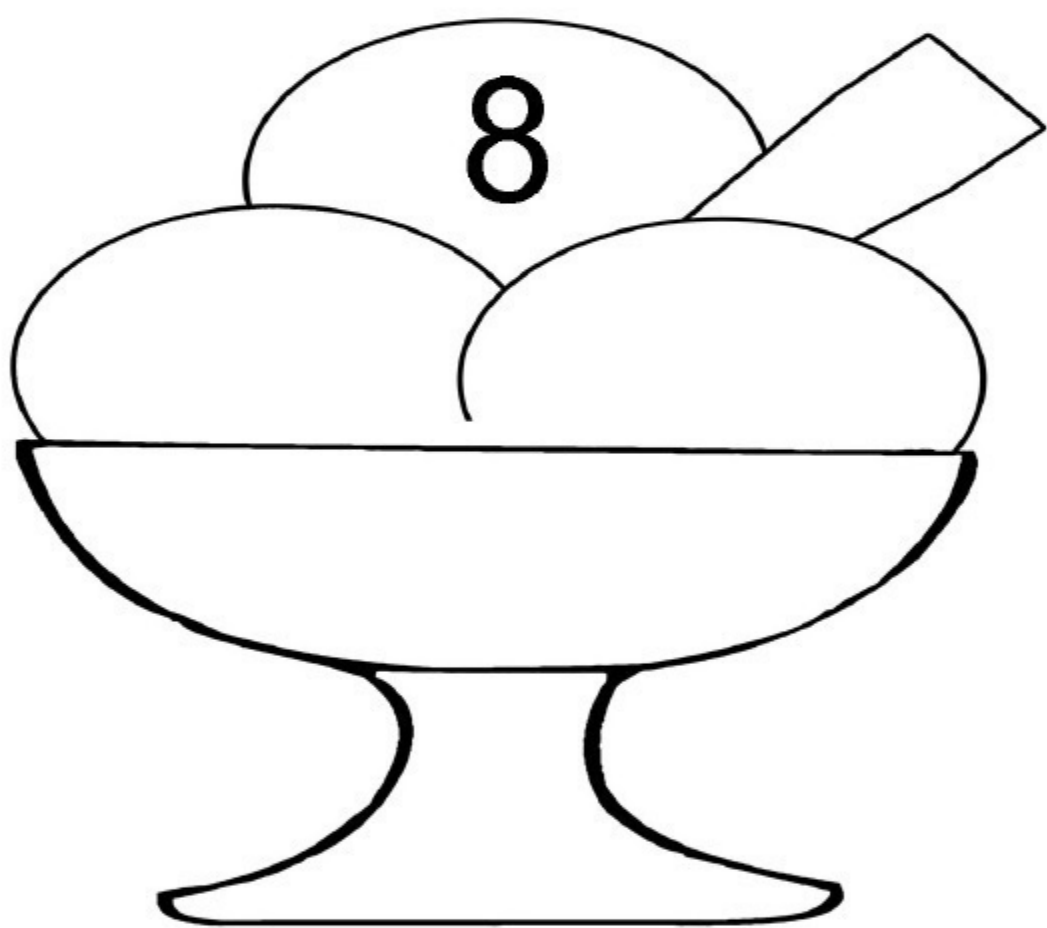
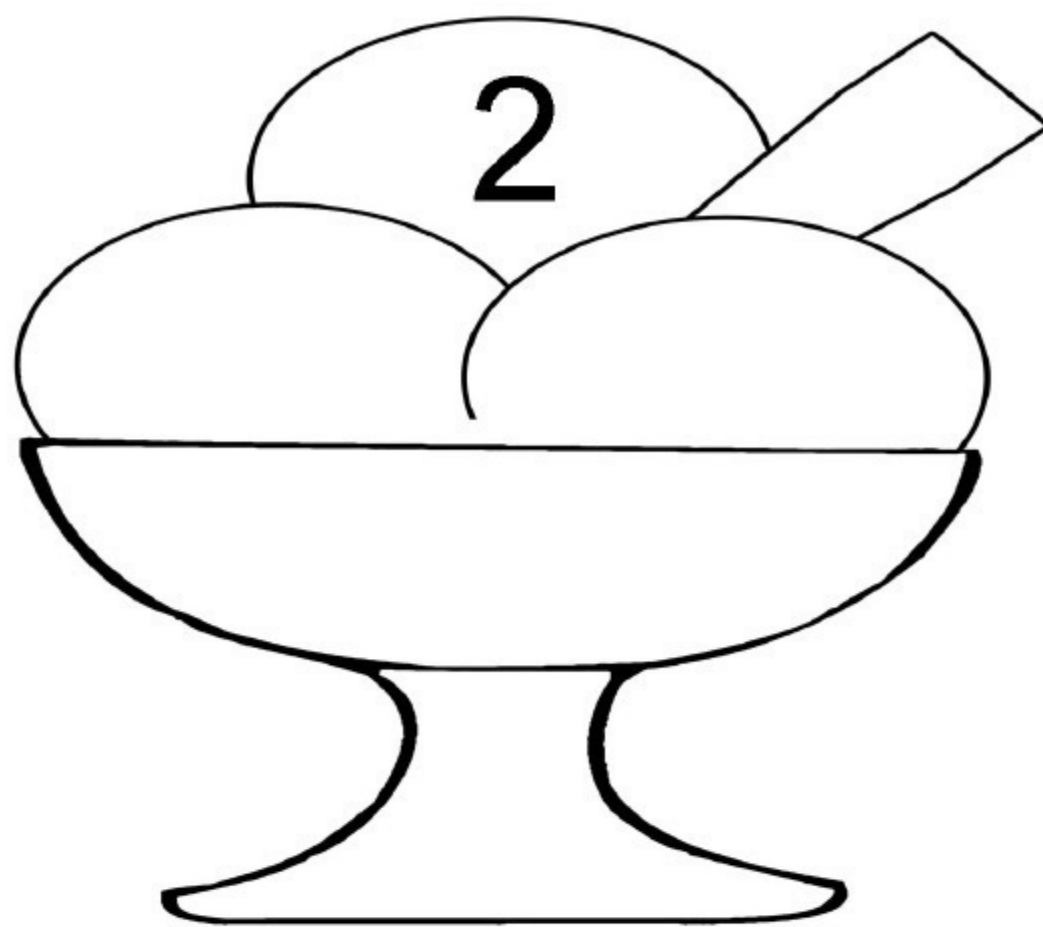
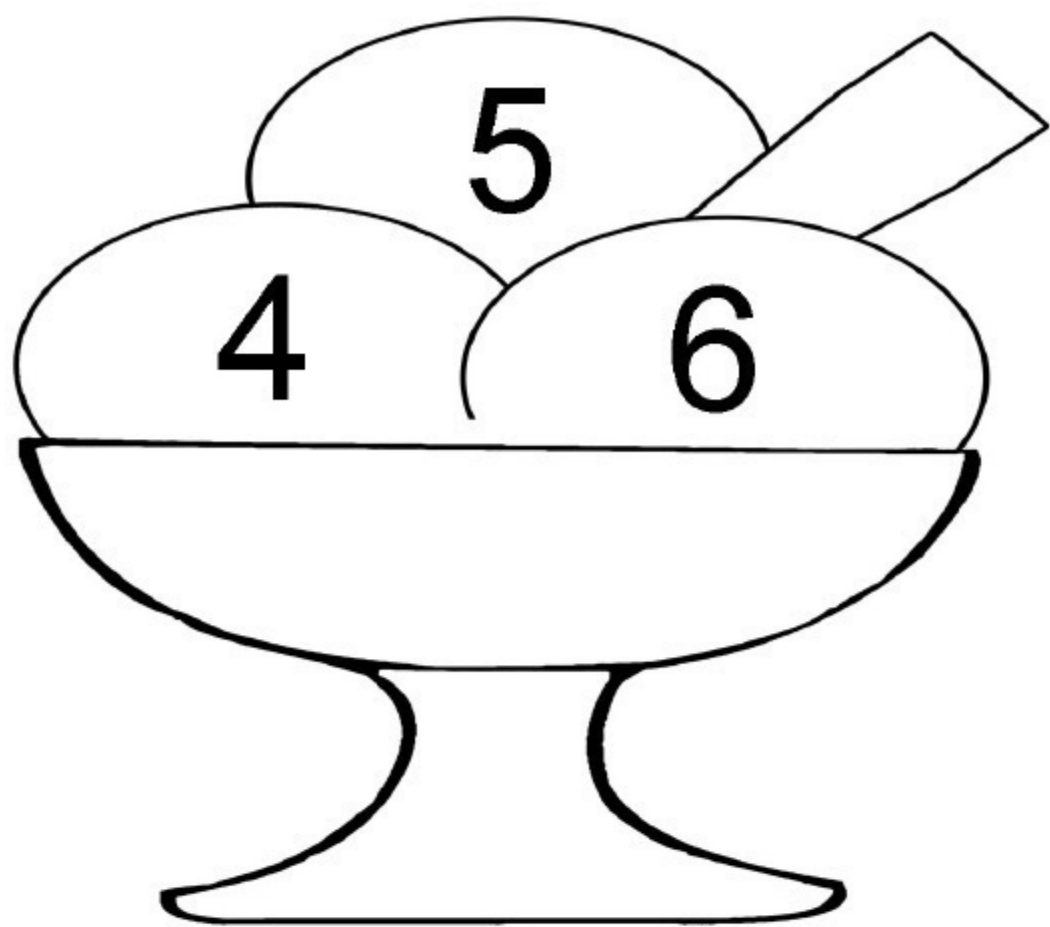

Исеци, па залепи картице правилно!

храна

није храна

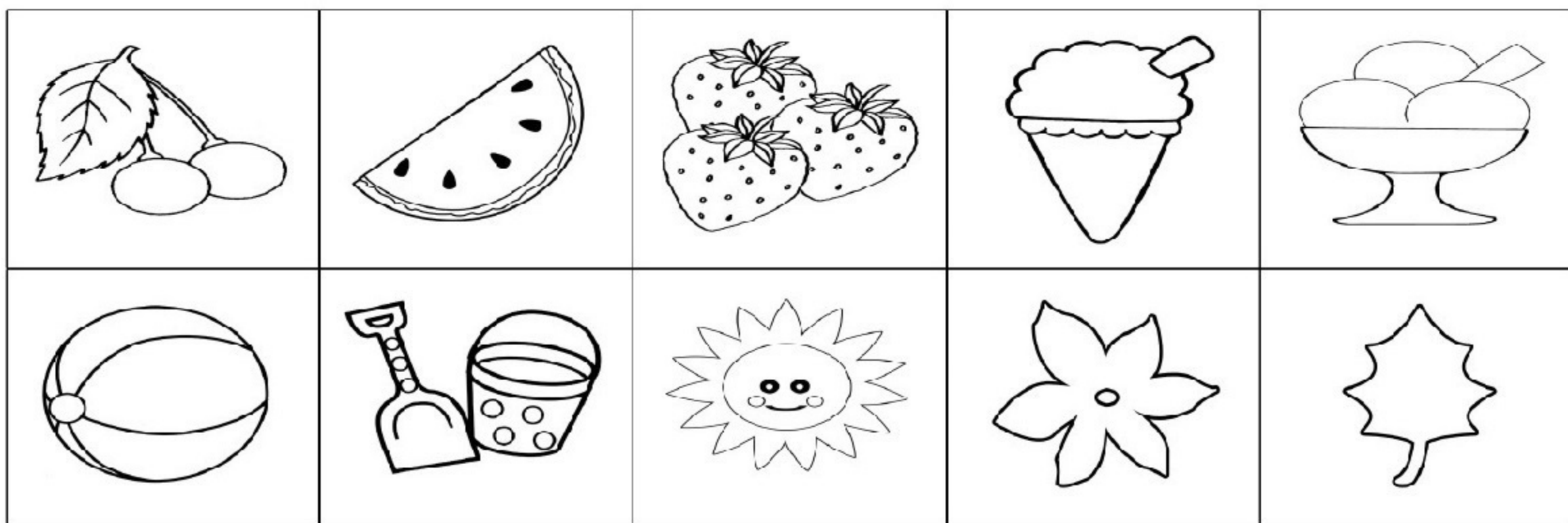

Настави као што је започето.

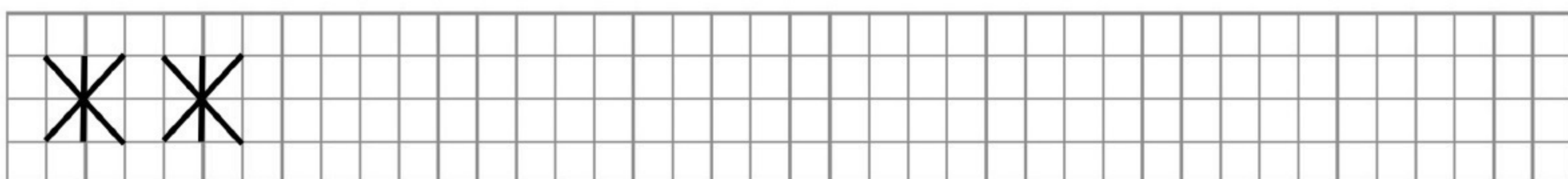
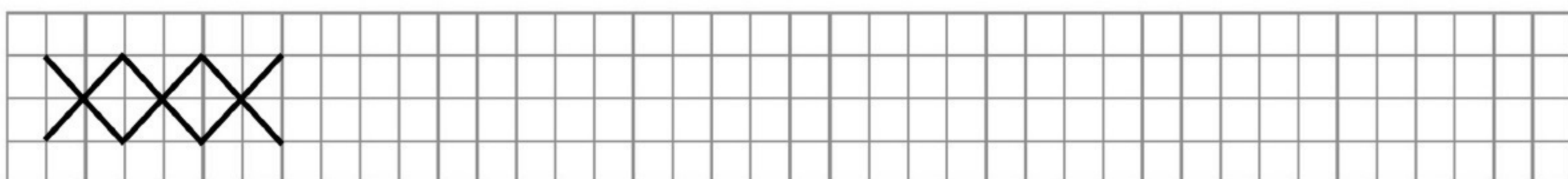
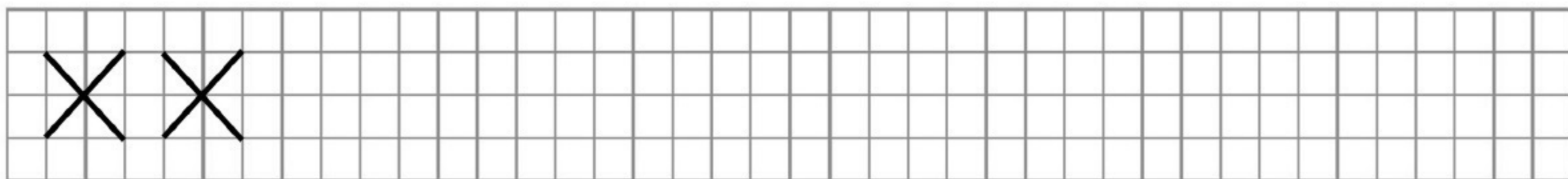
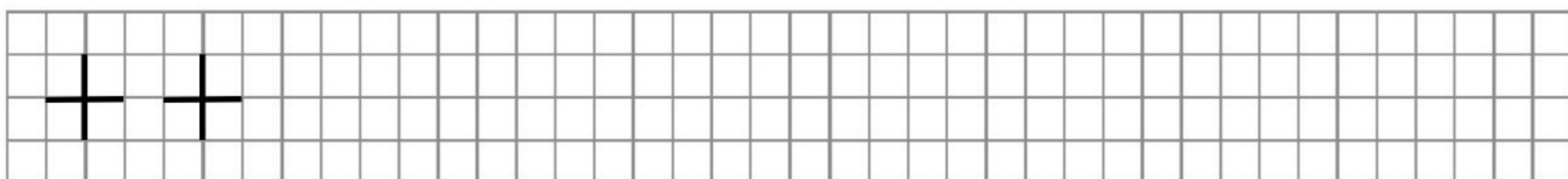
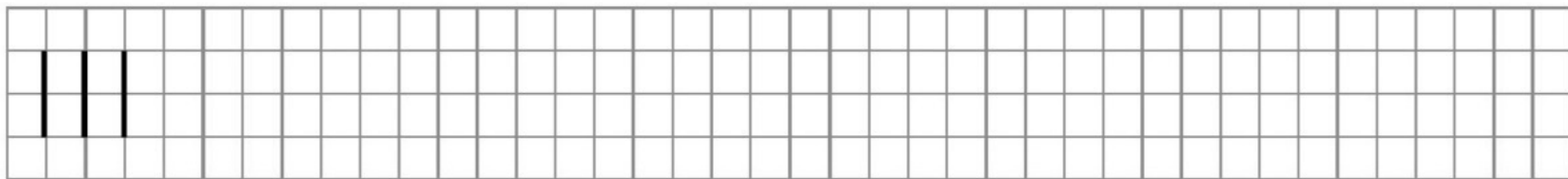
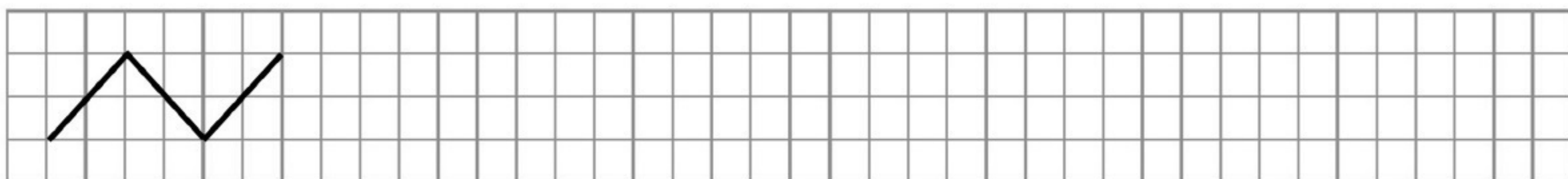
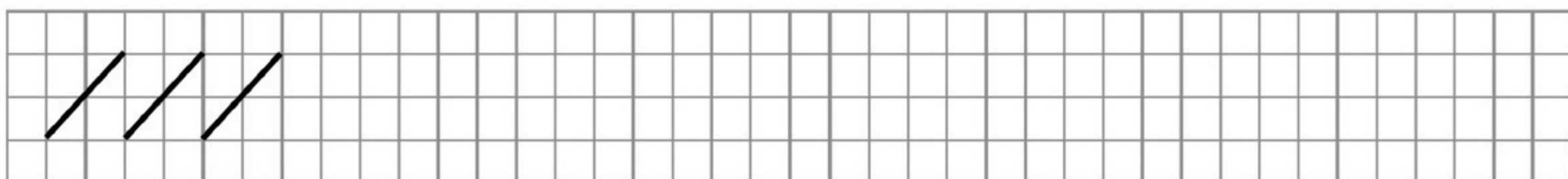
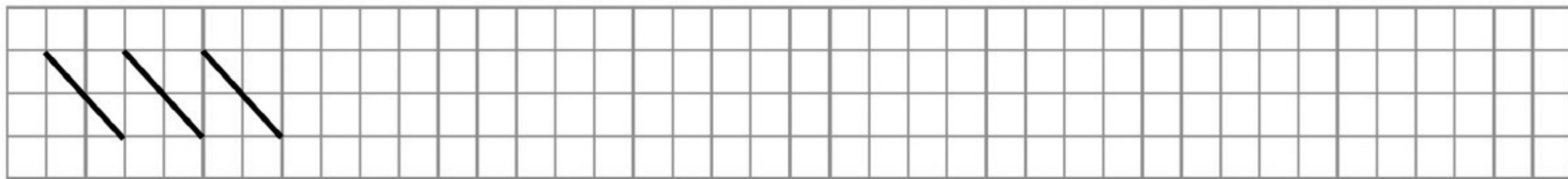
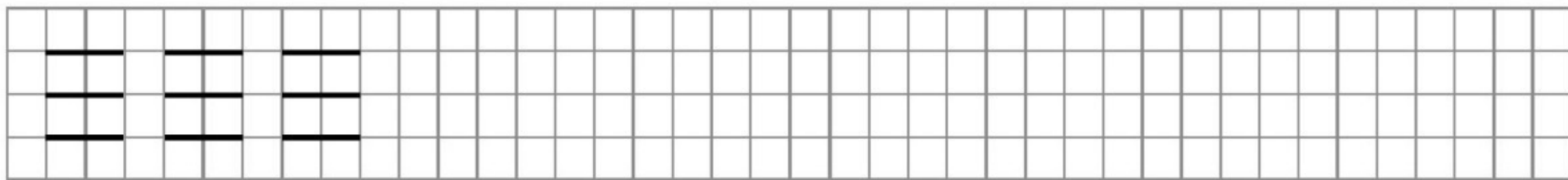

Настави као што је започето.

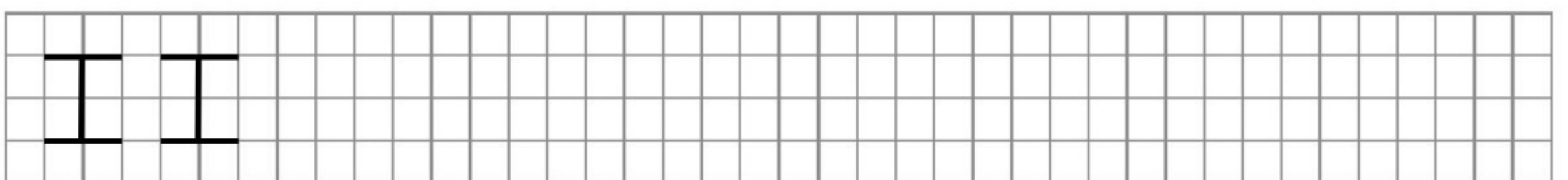
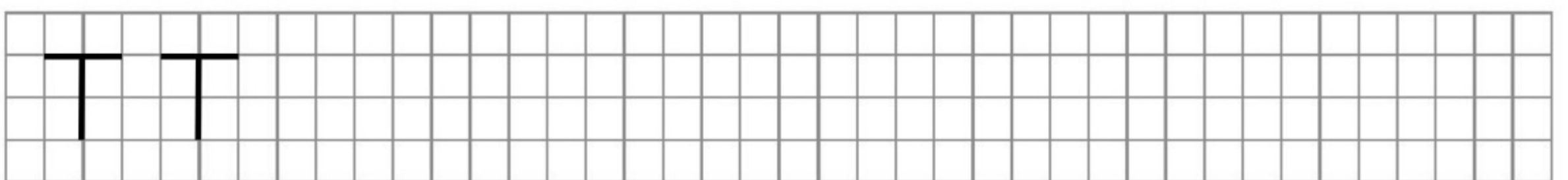
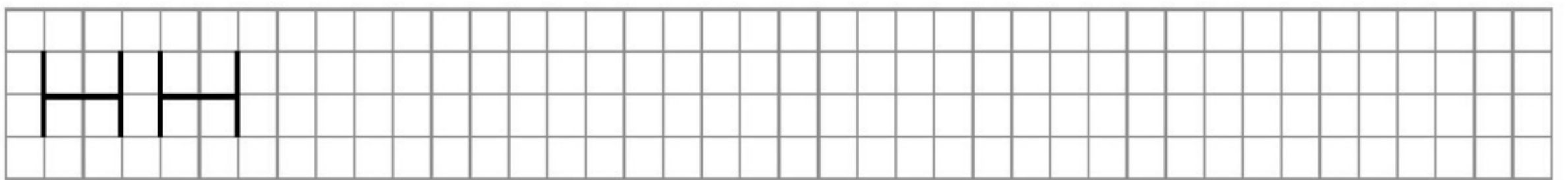
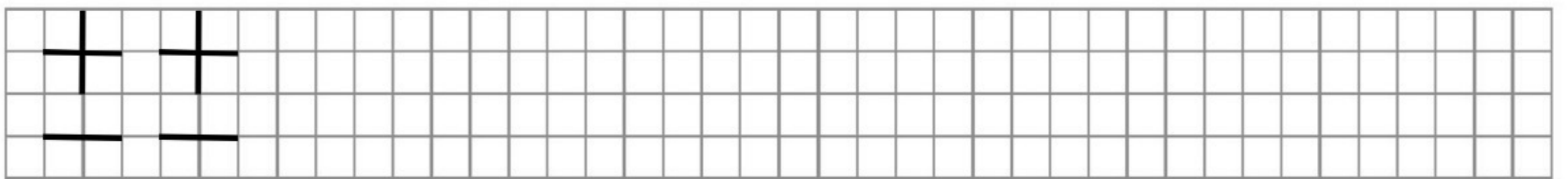
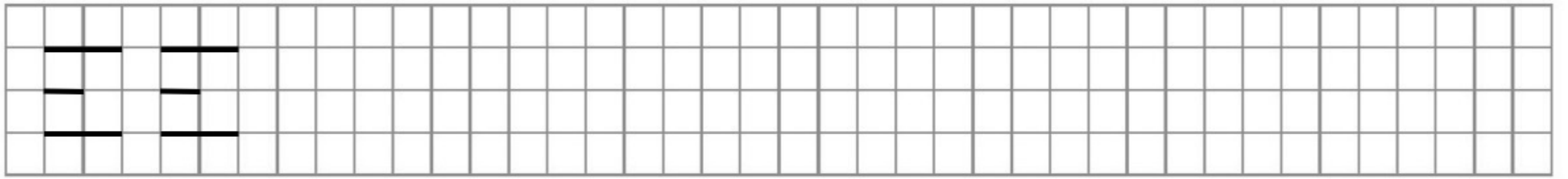
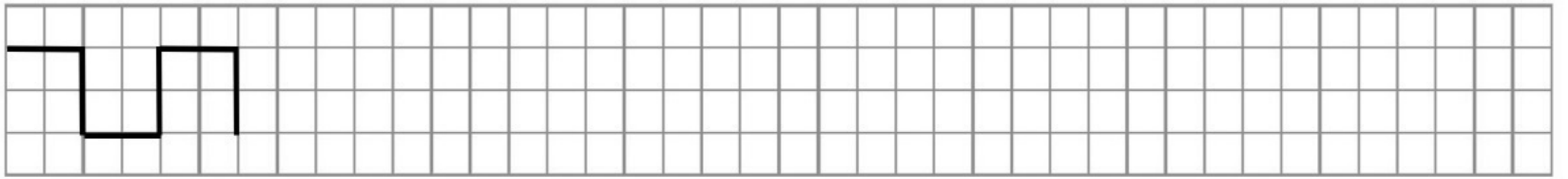
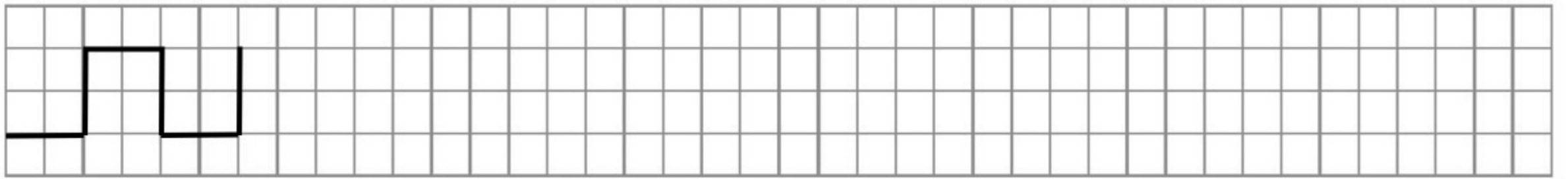
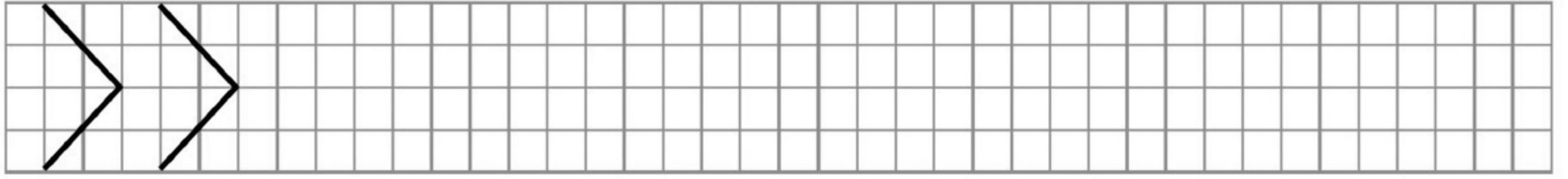
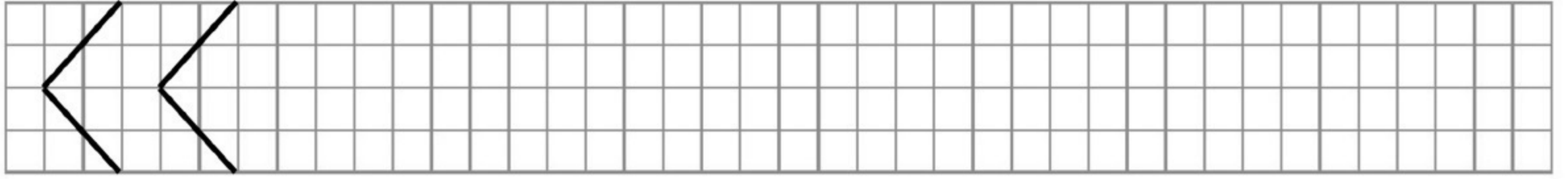

Настави као што је започето.

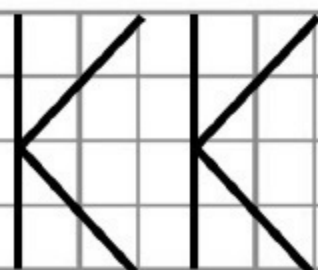
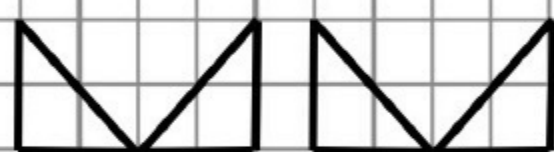
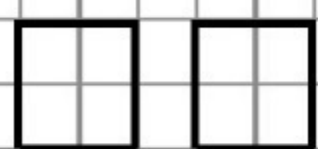

Настави као што је започето.

С С

О О

8 8

р р

б б

д д

в в

о о

о о

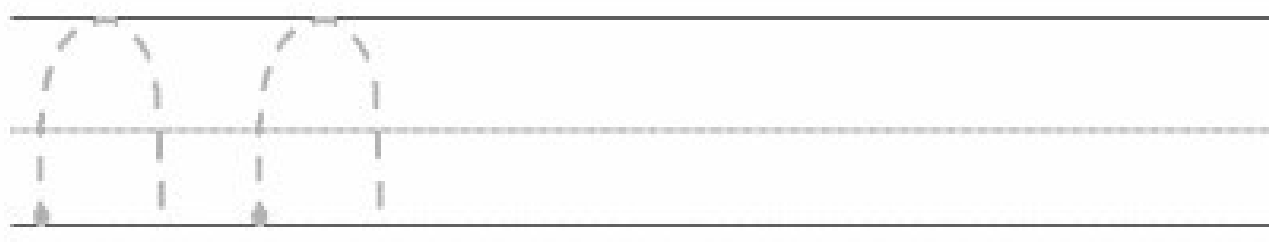
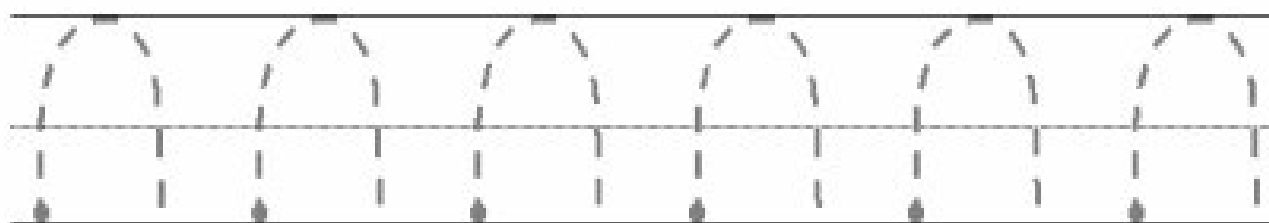
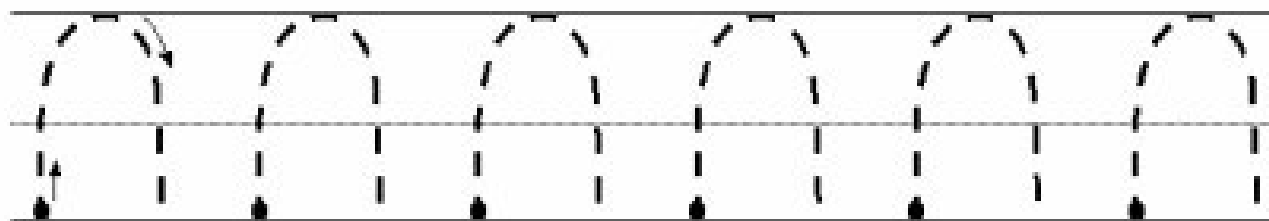
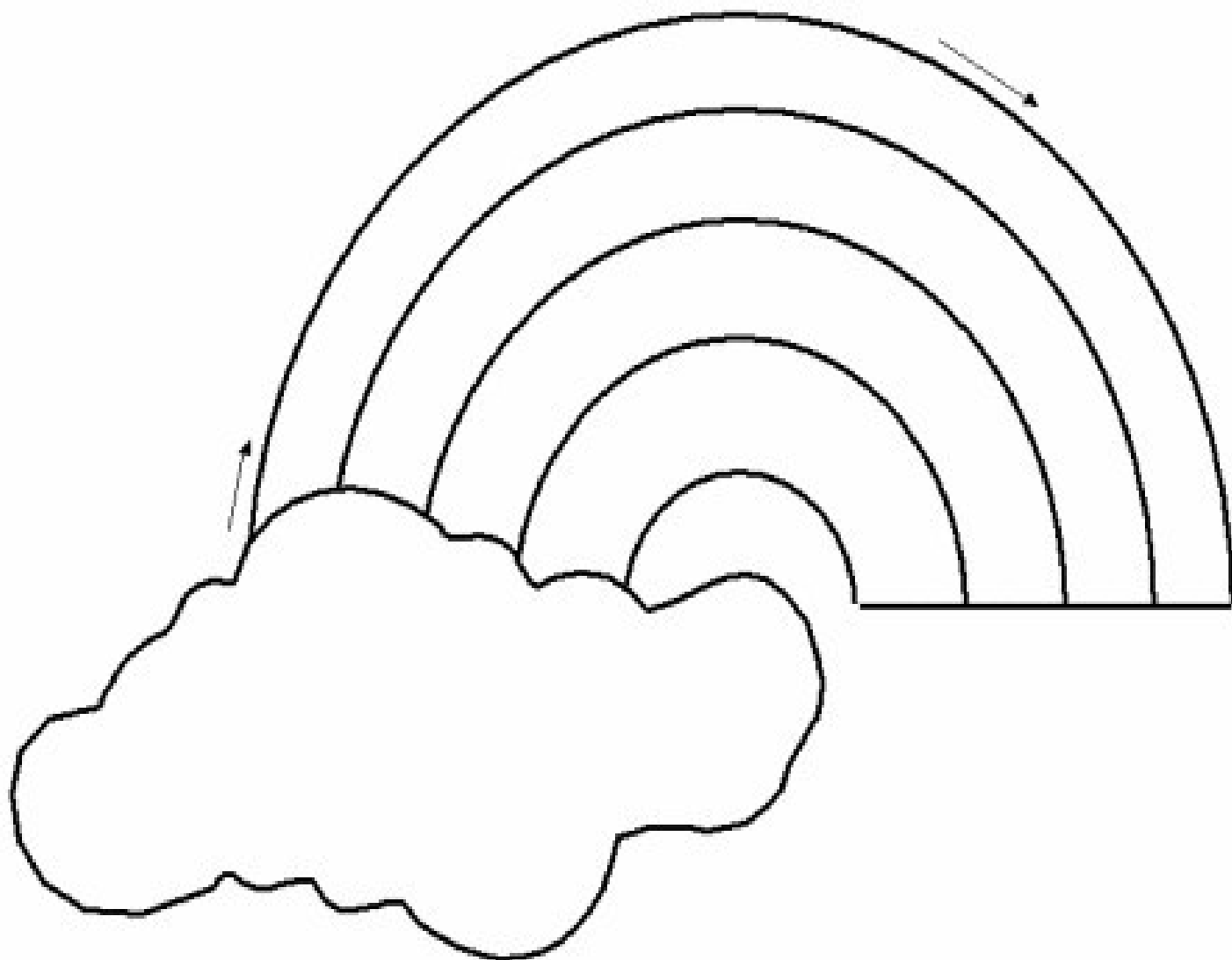

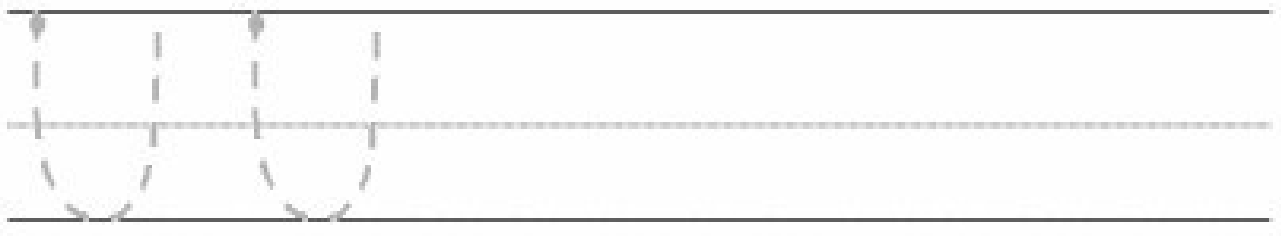
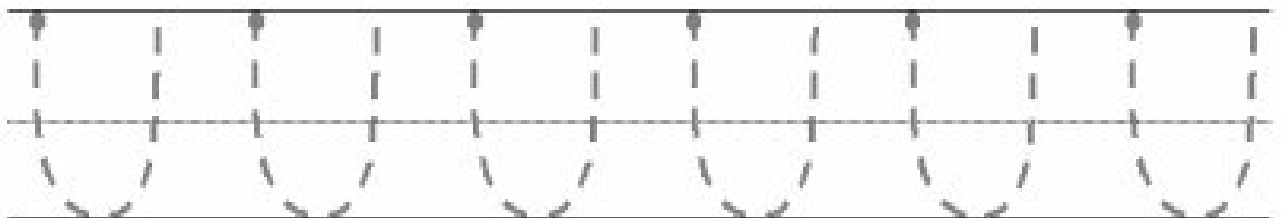
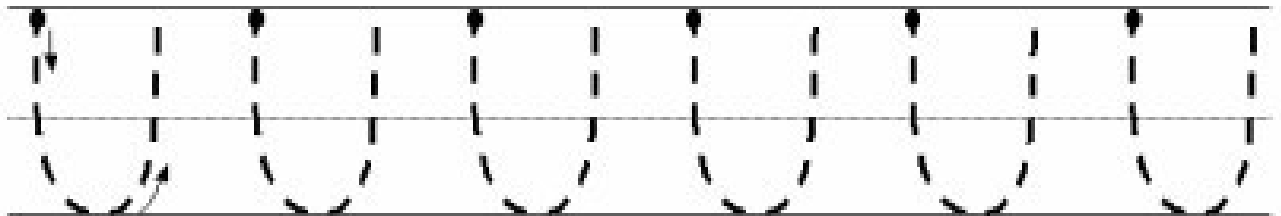
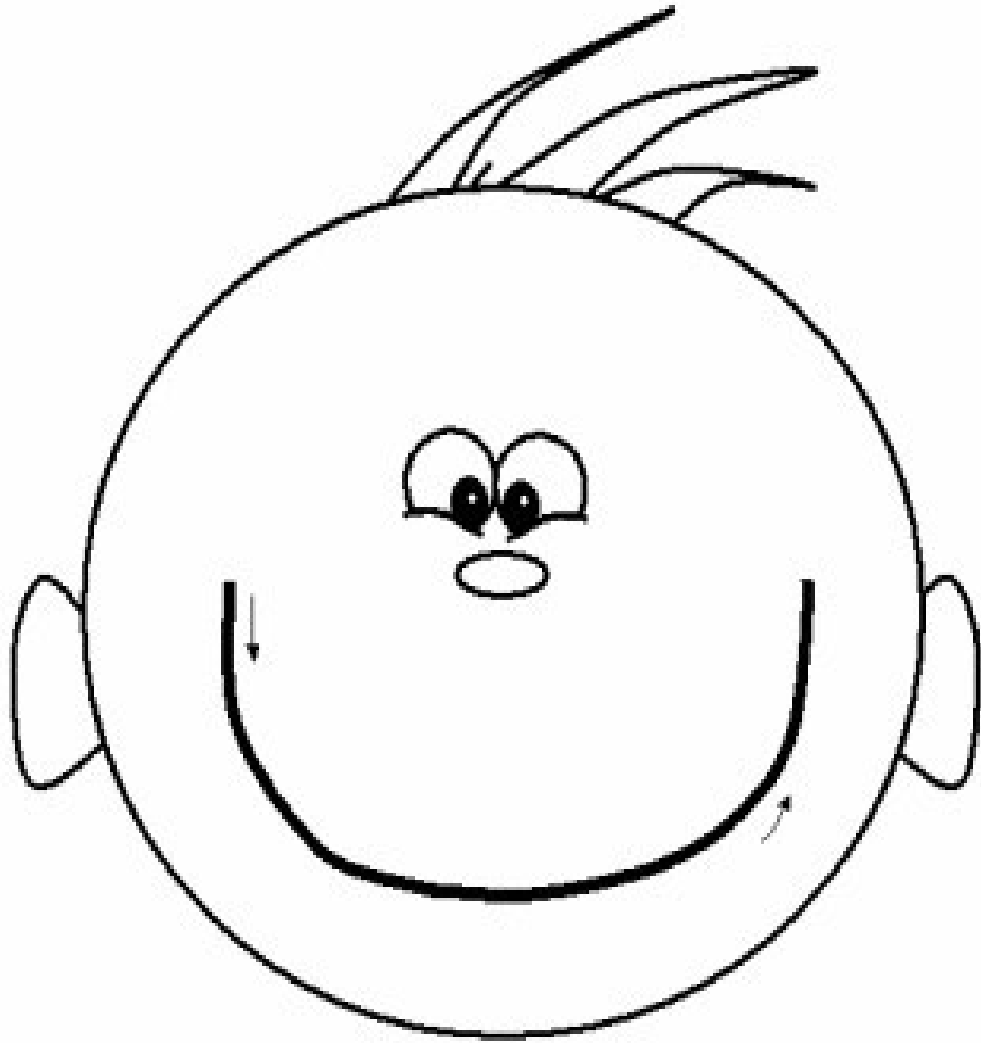

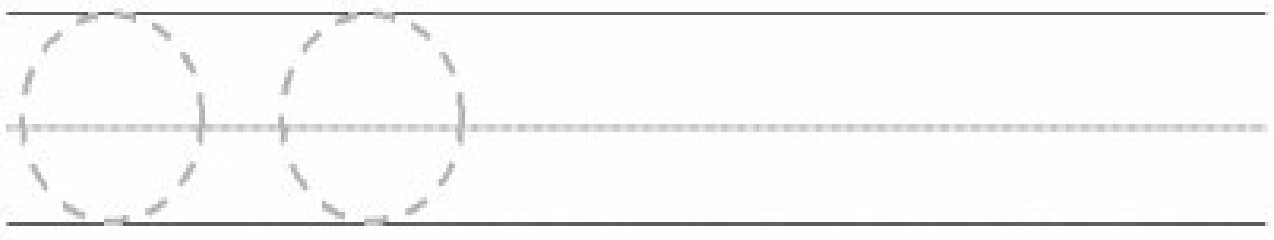
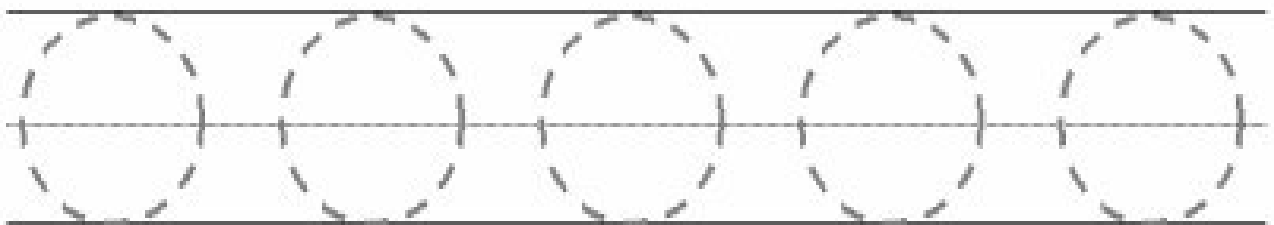
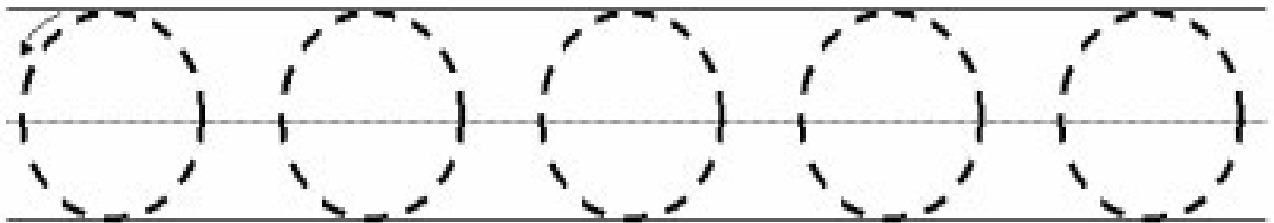
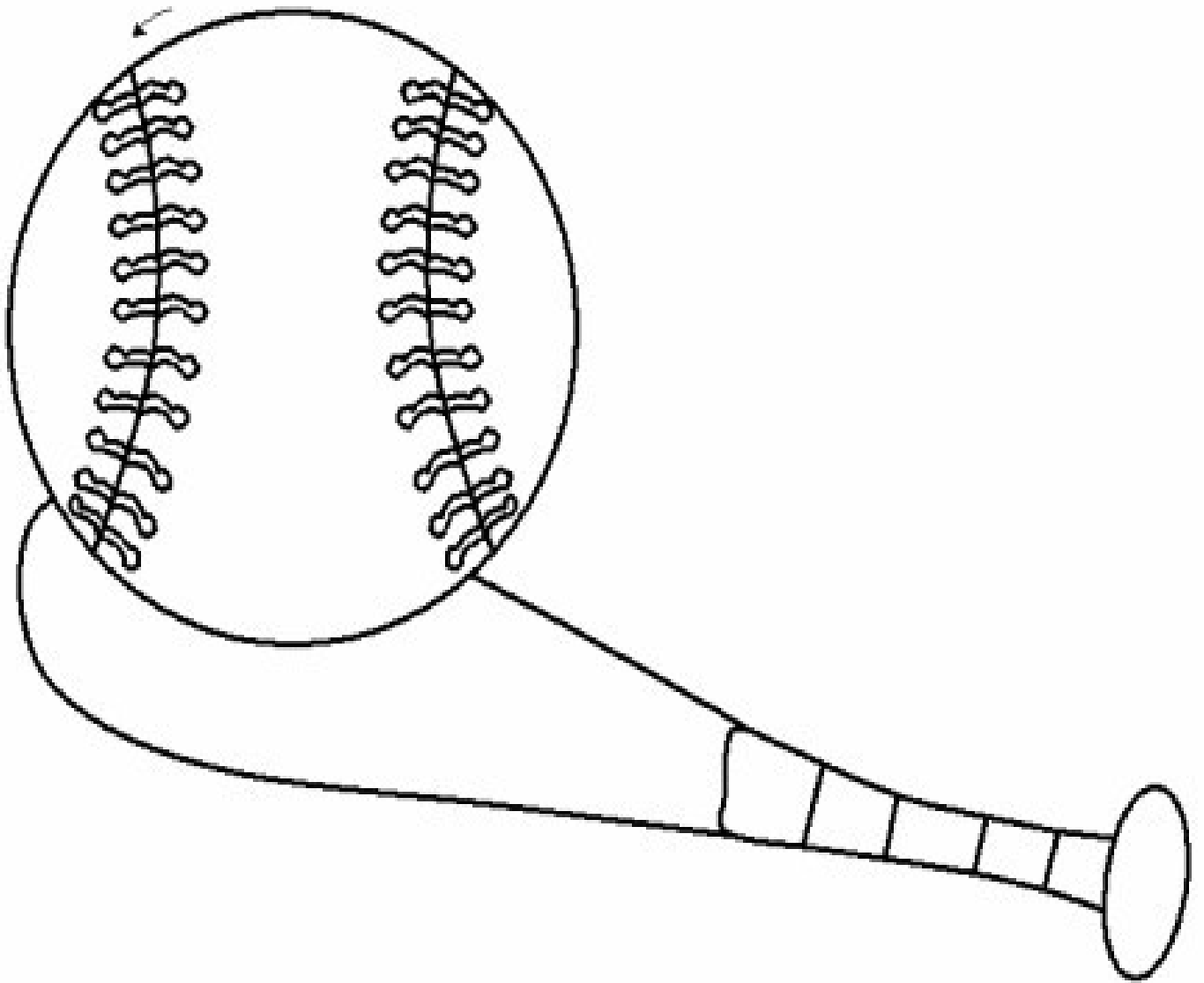

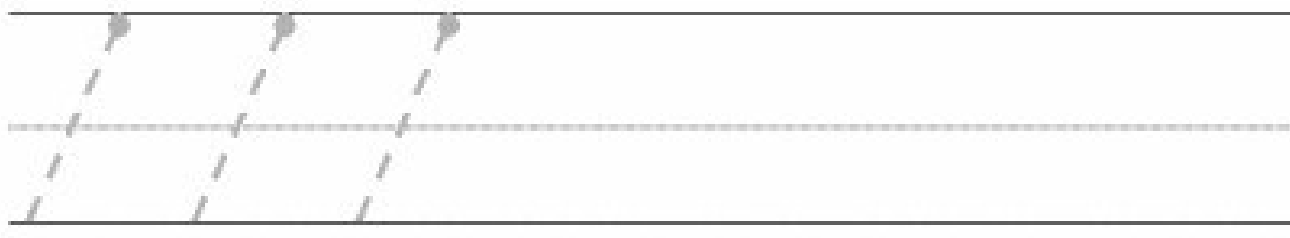
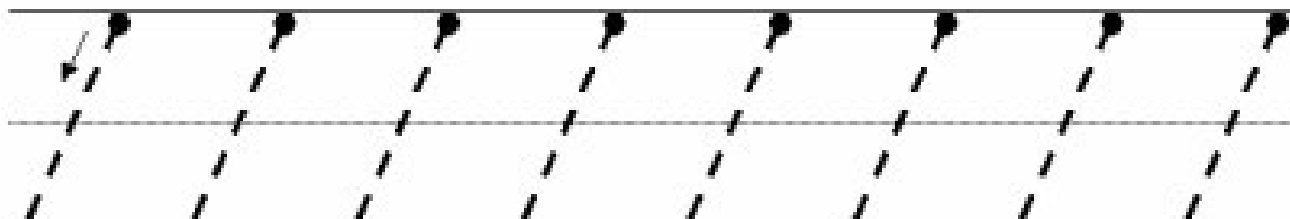

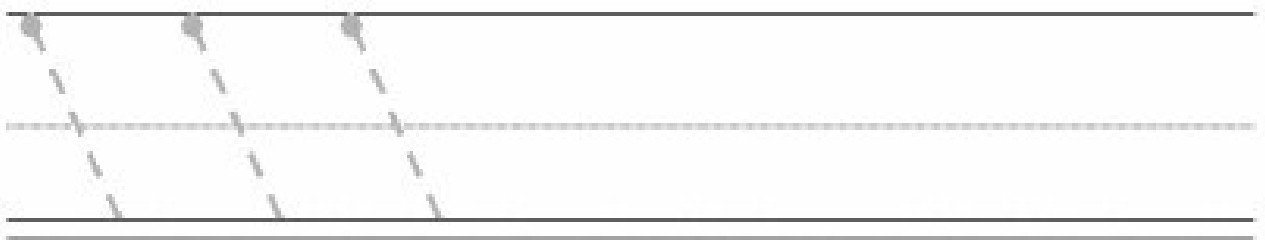
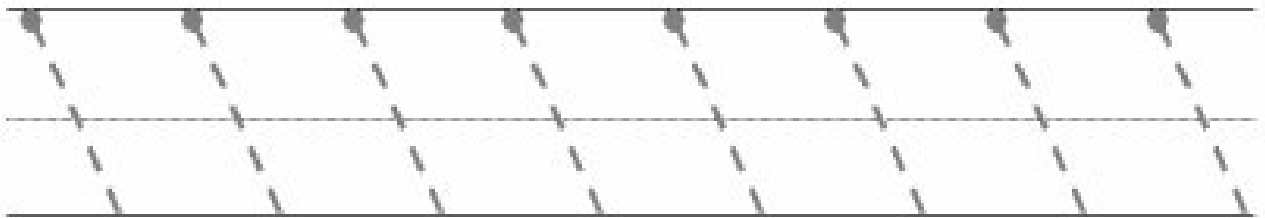
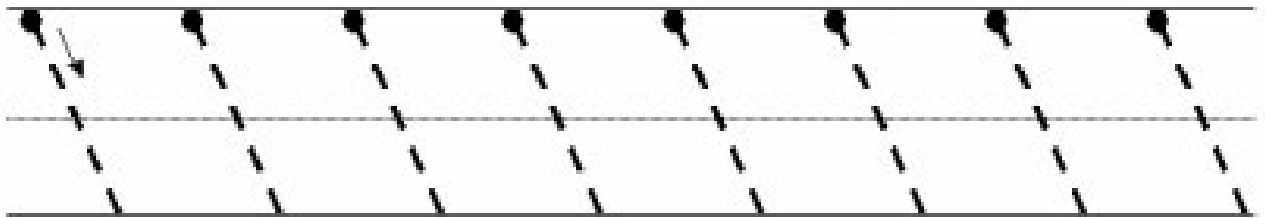
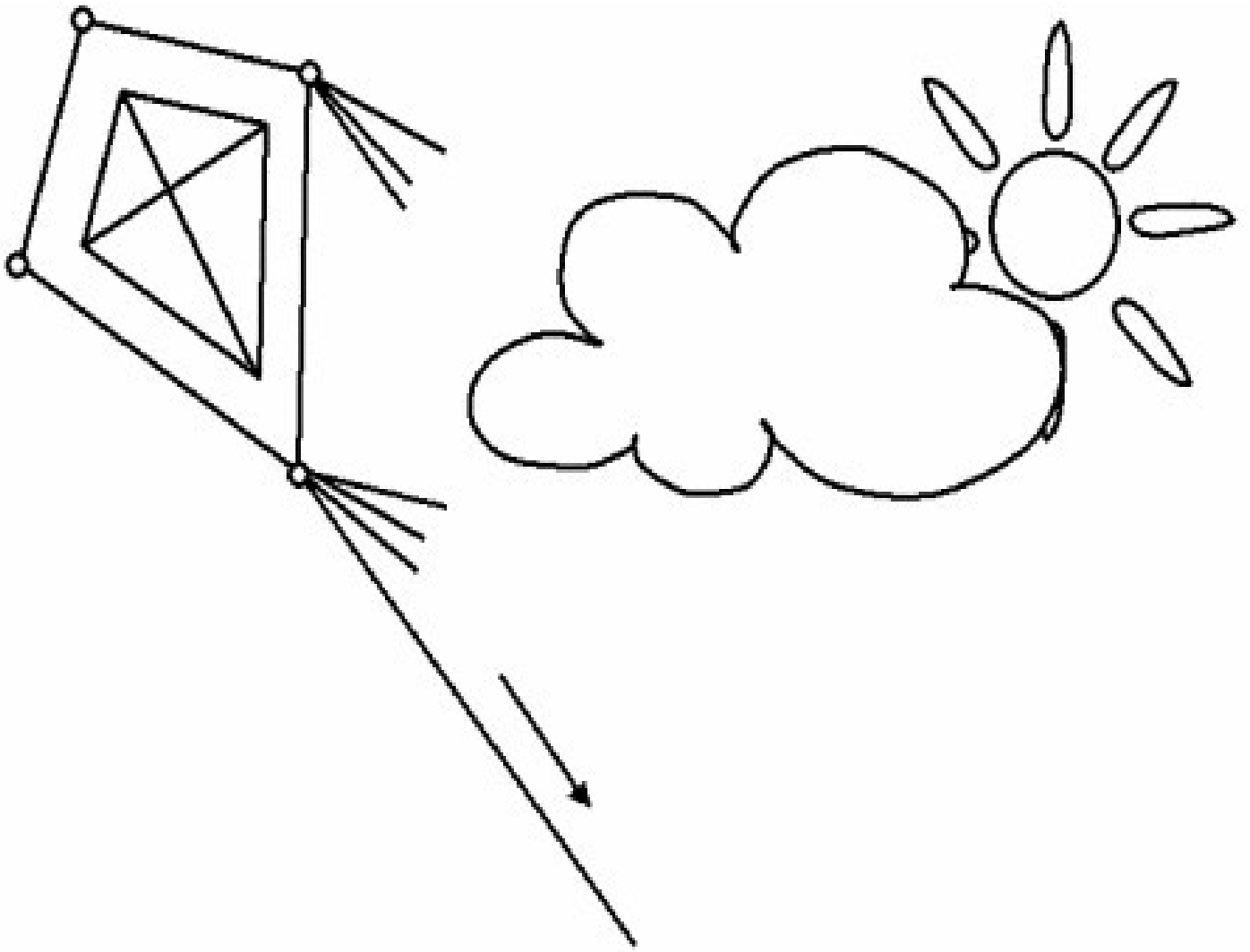

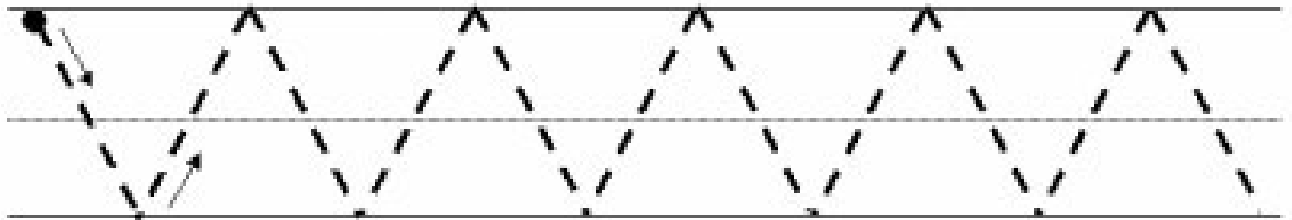
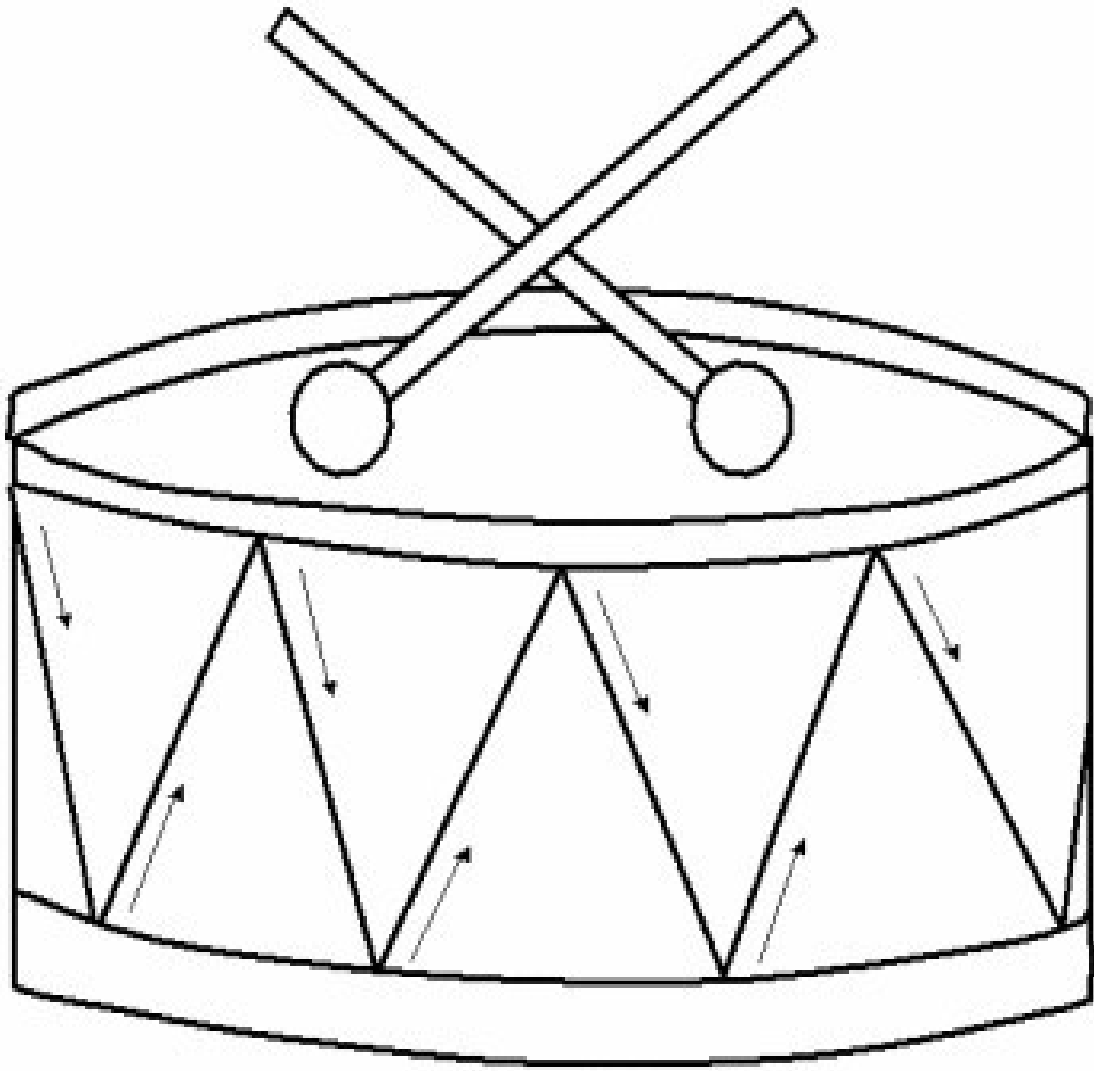

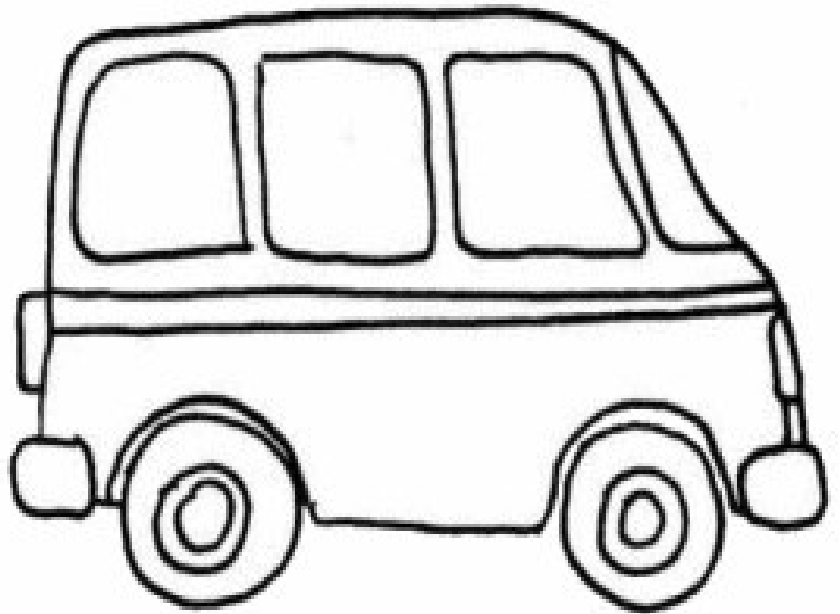
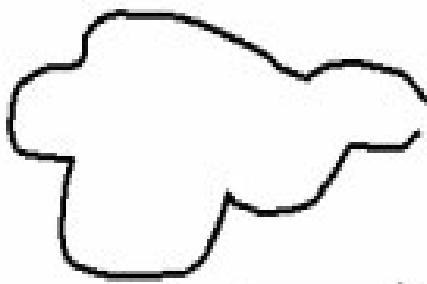
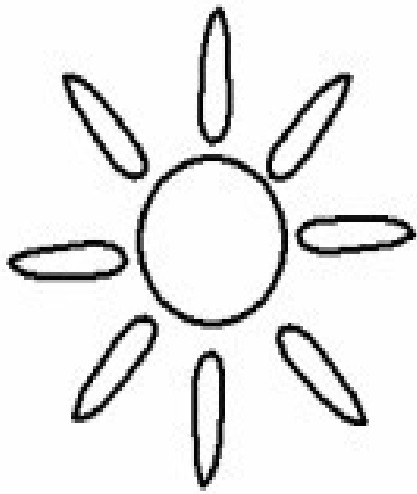

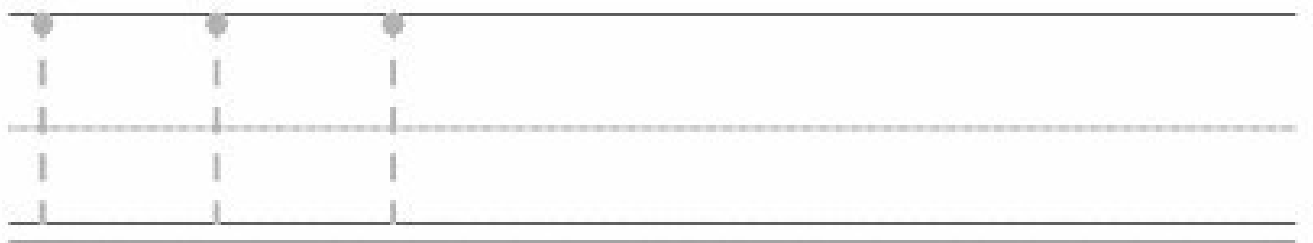
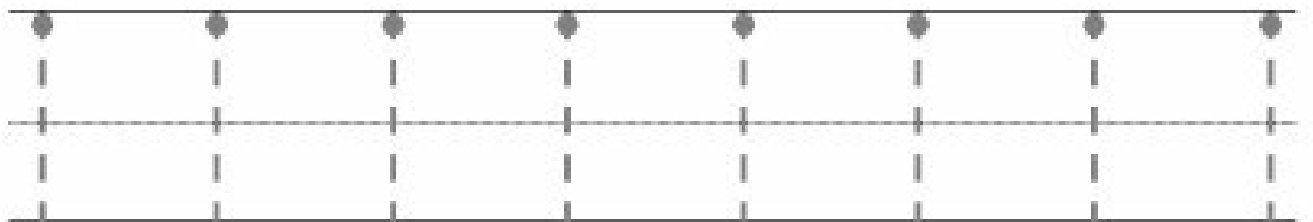
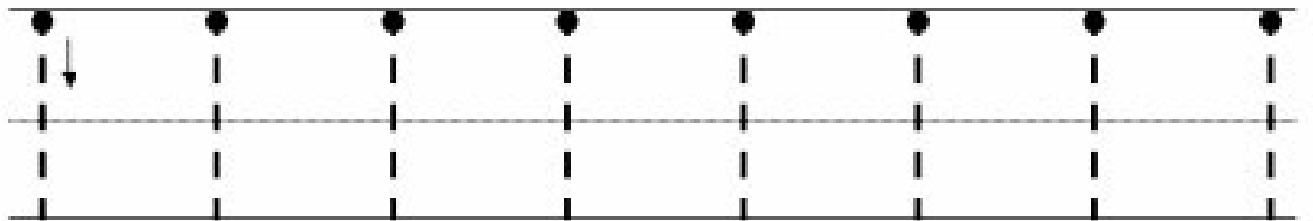
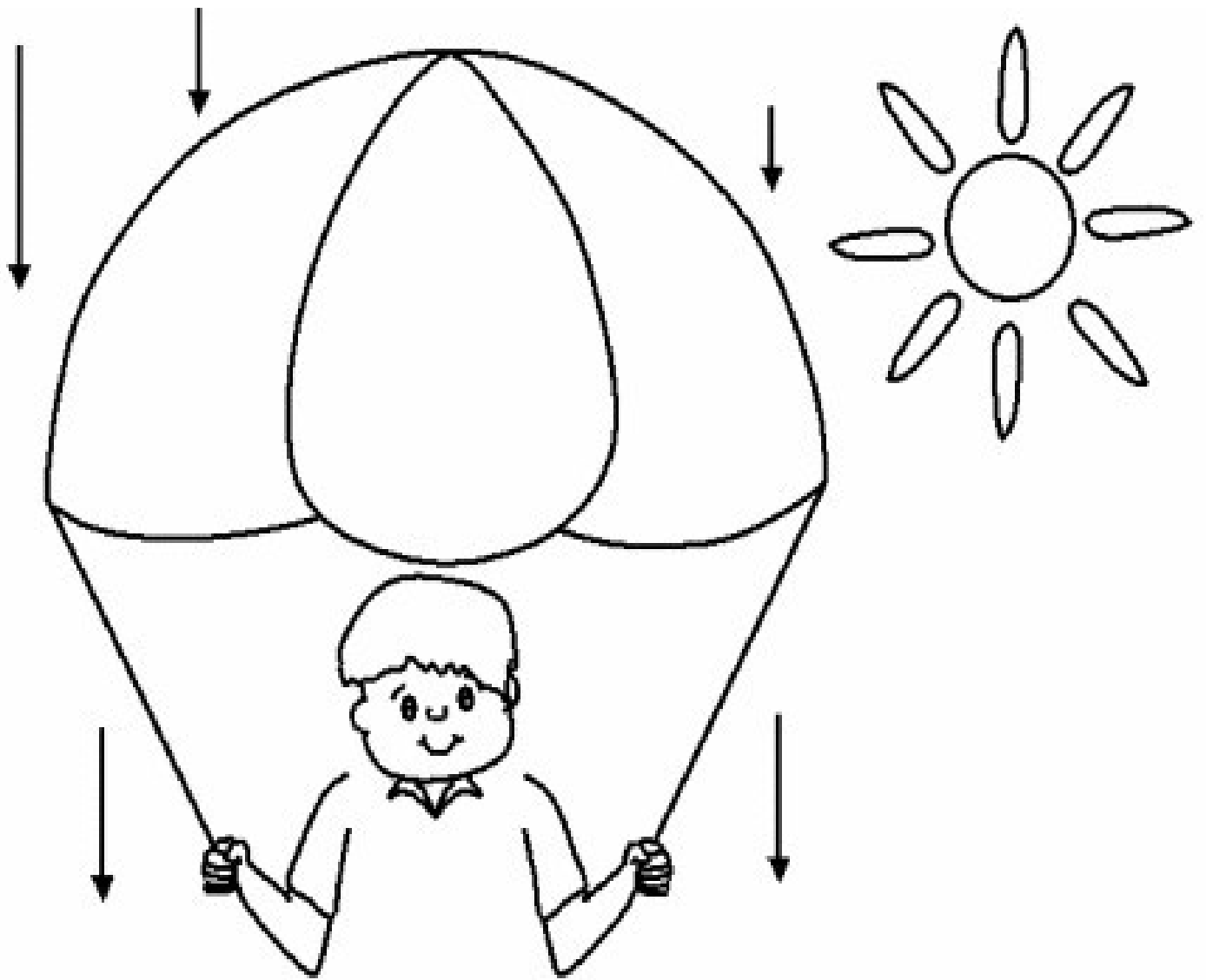

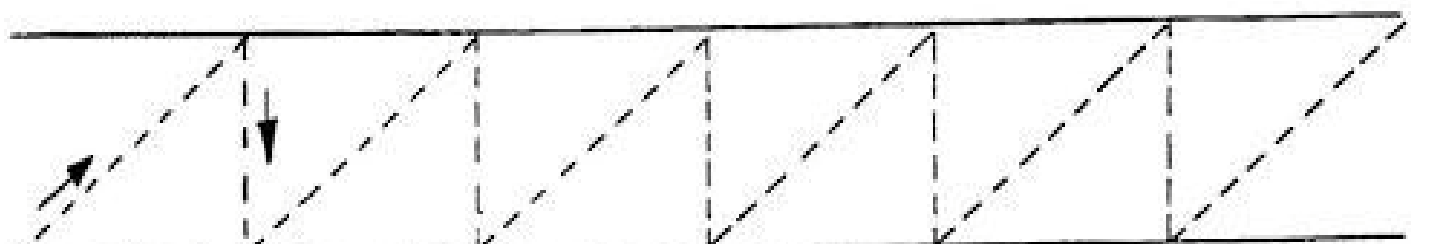
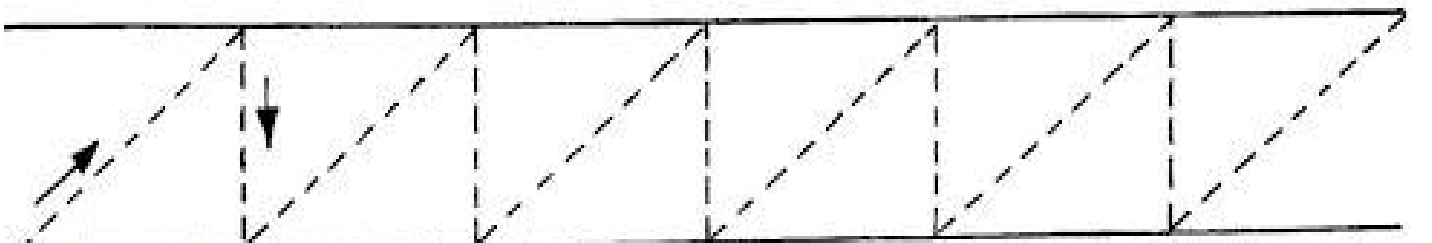
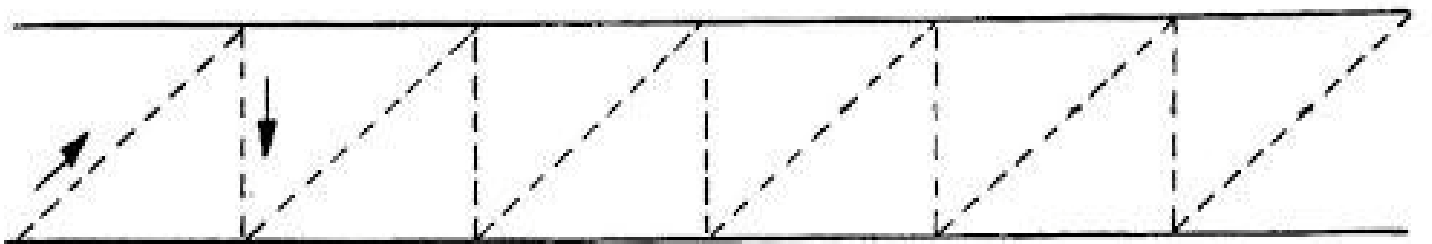
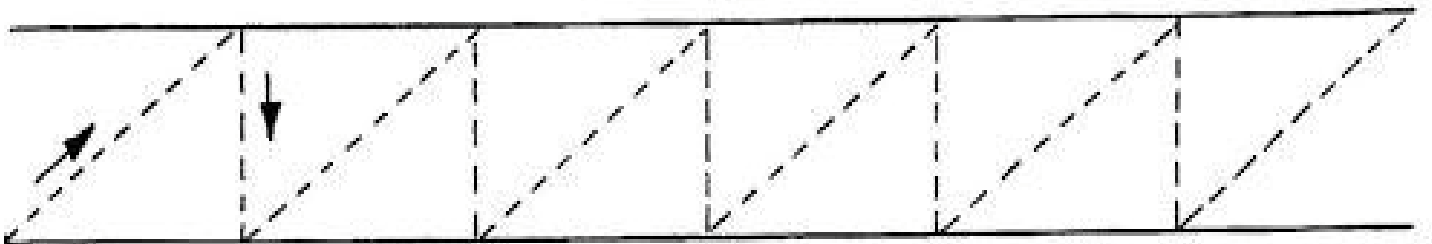
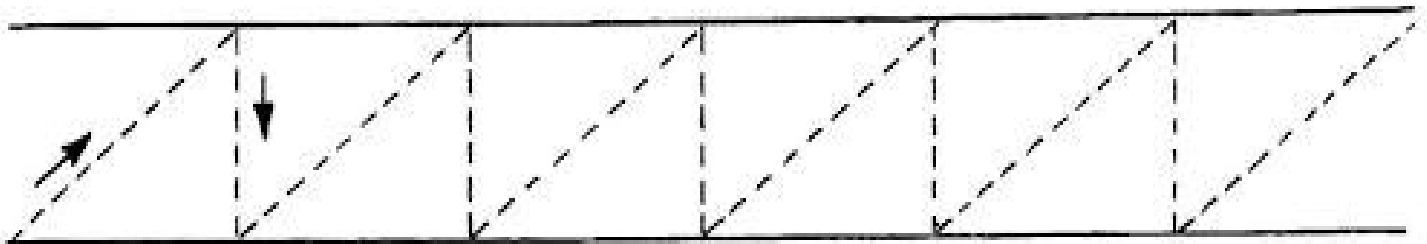
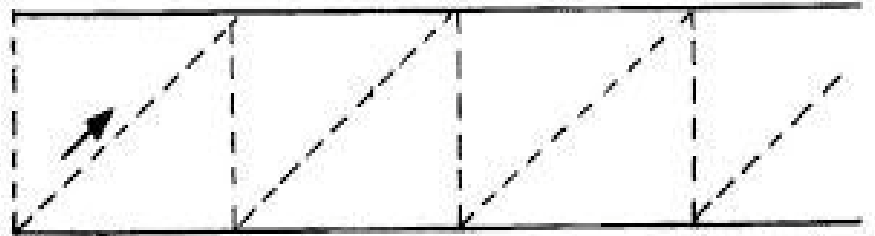
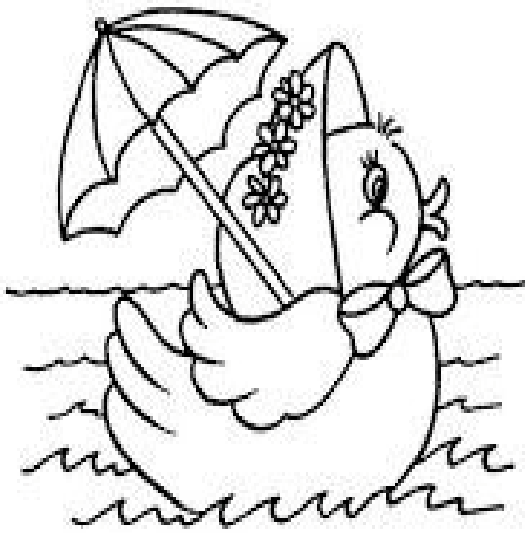

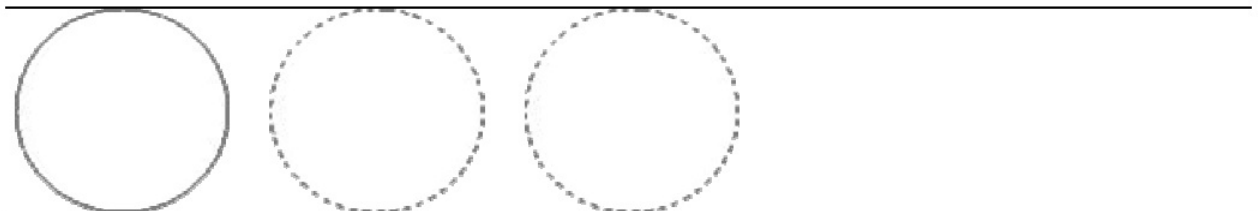
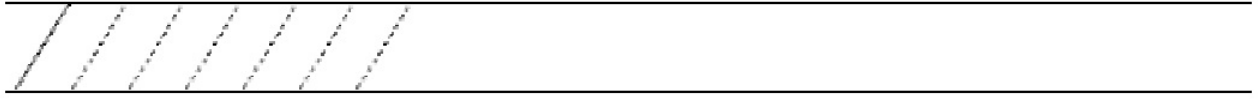

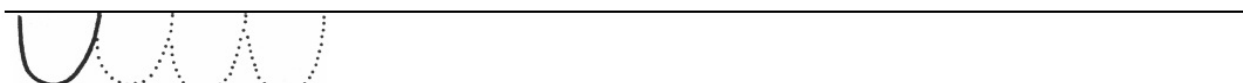
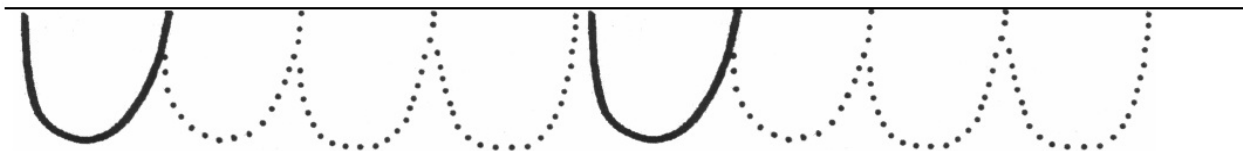
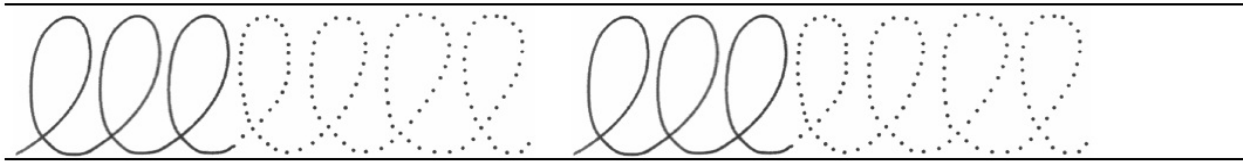
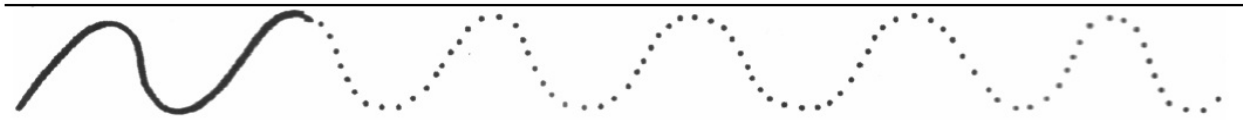
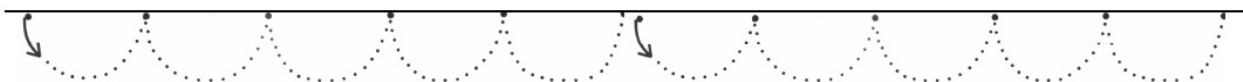
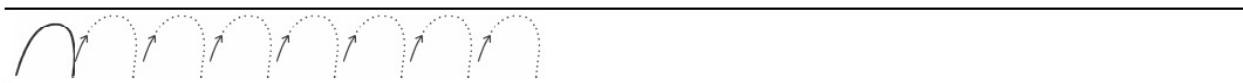
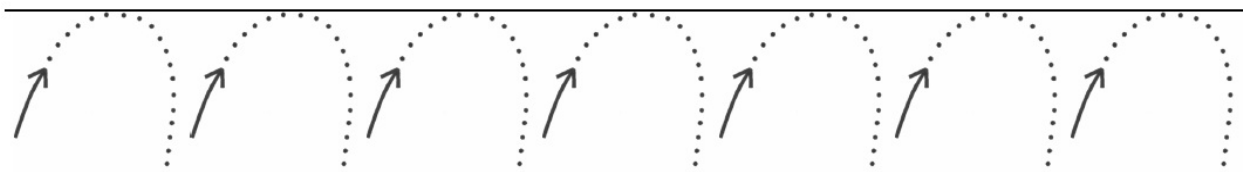

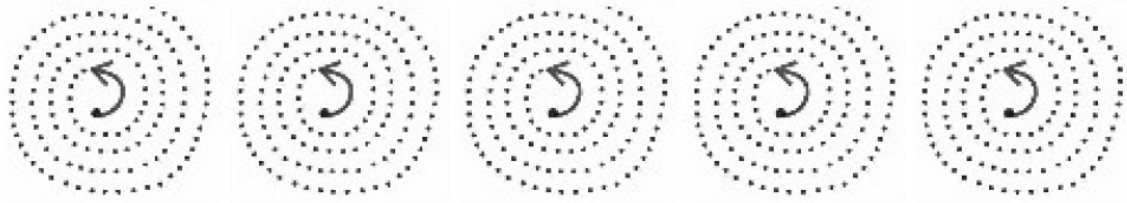

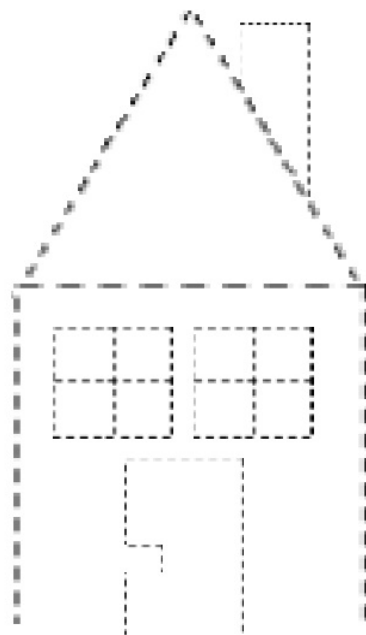
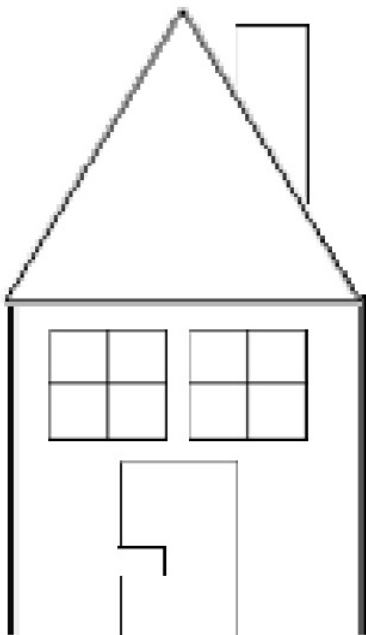
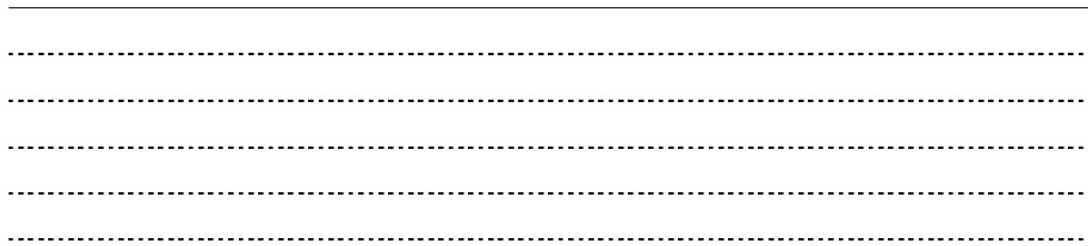
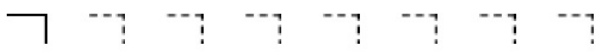
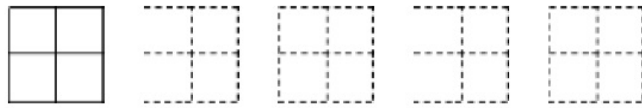

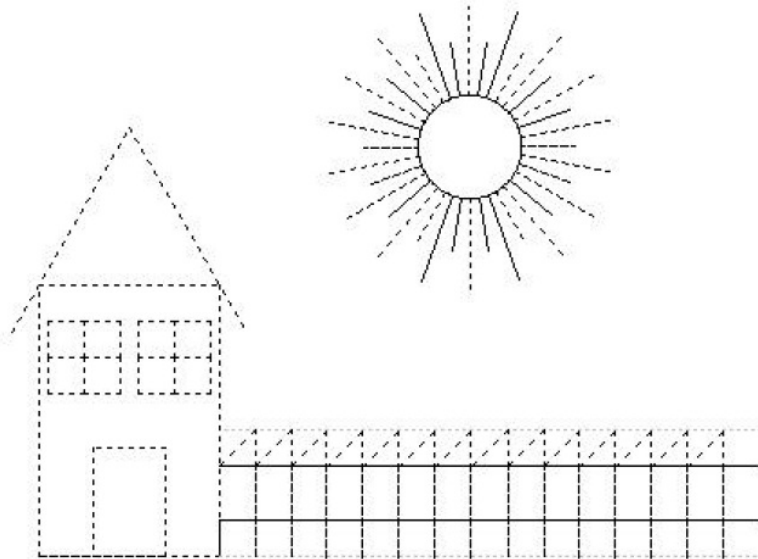
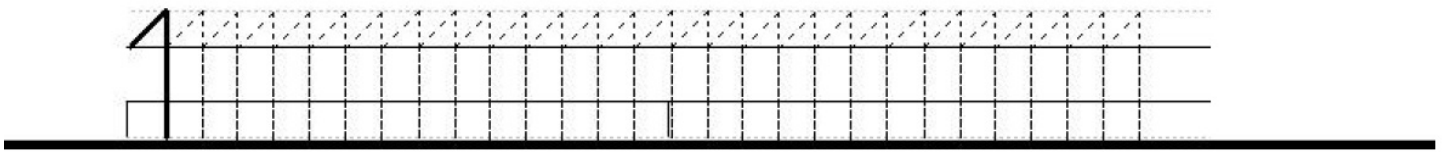
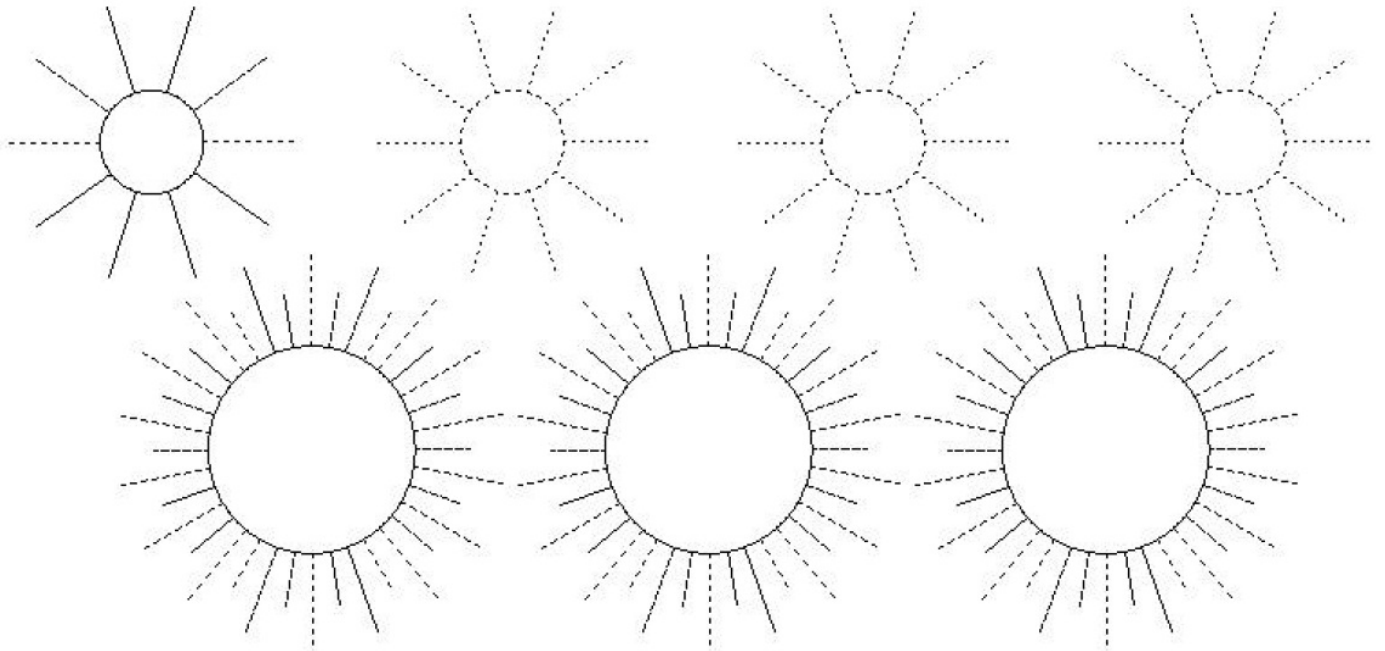

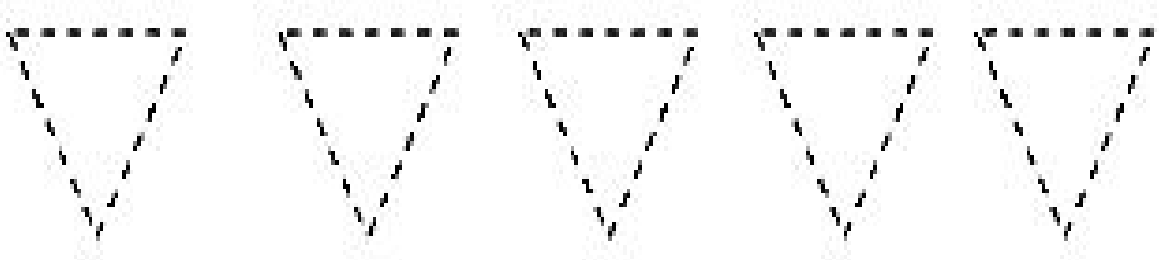
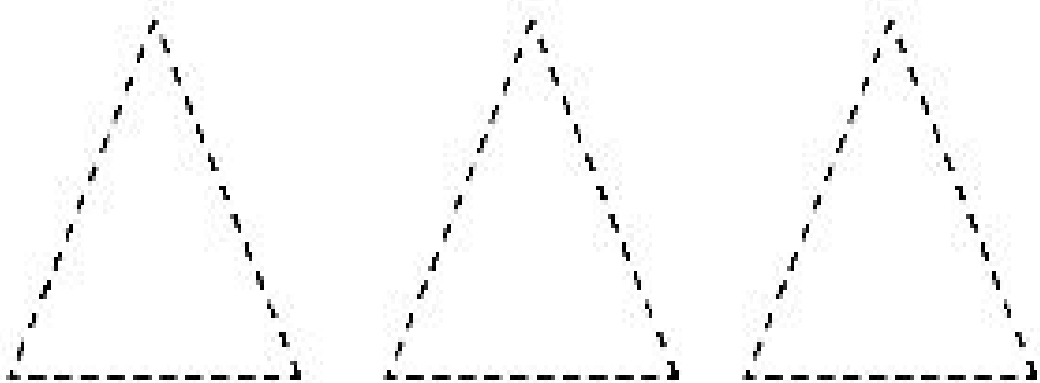
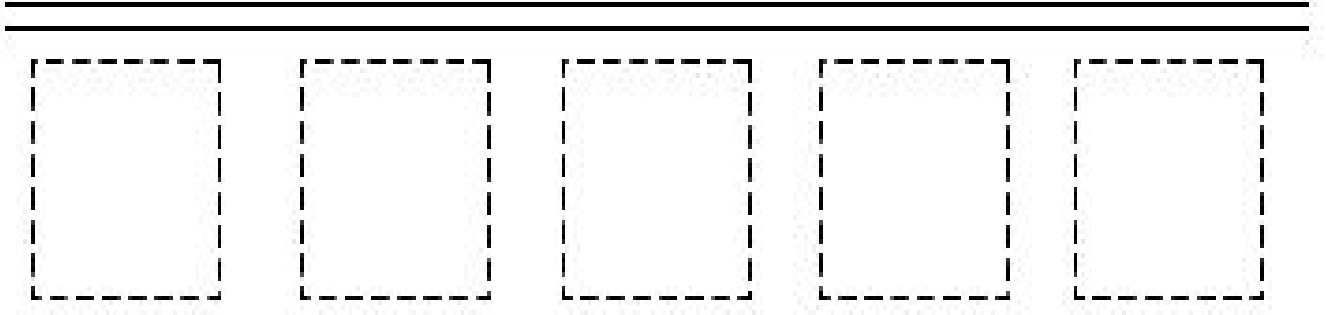
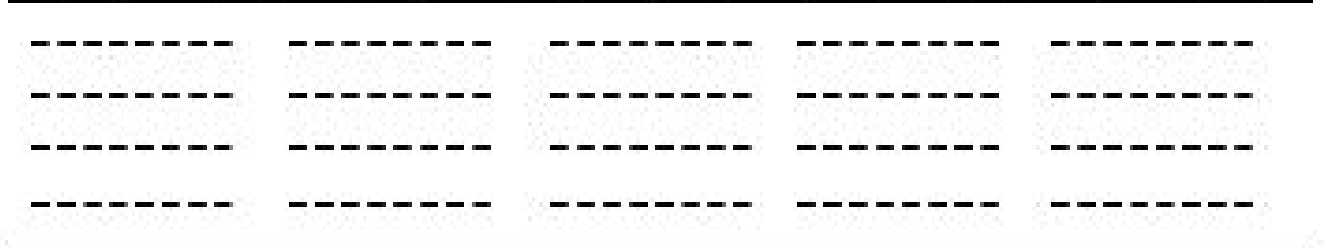
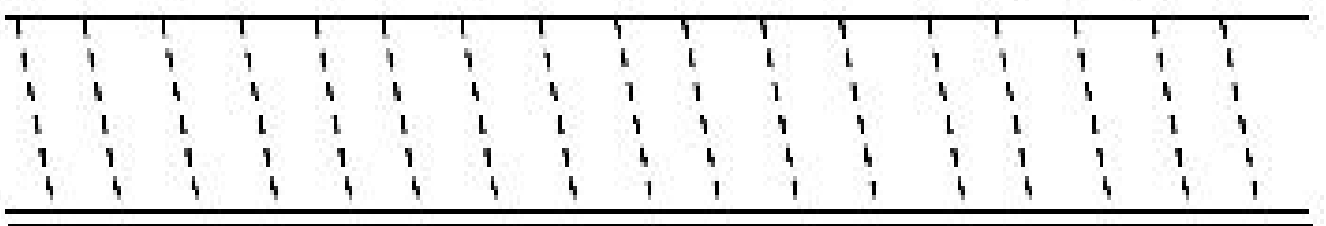
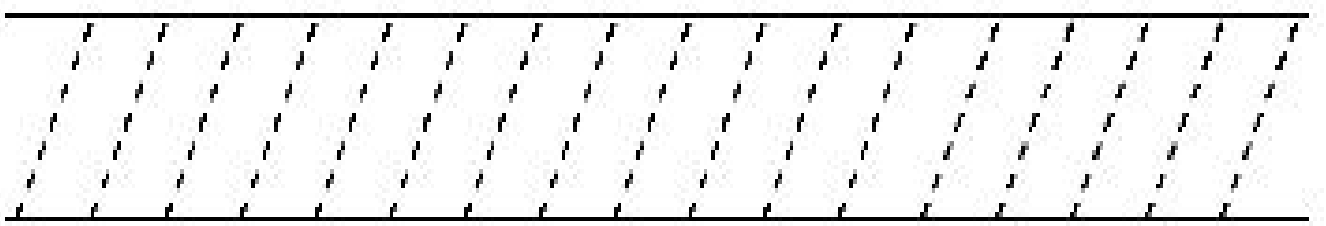
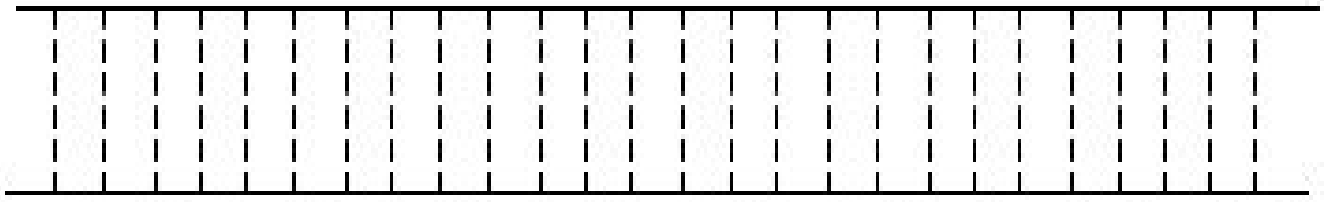

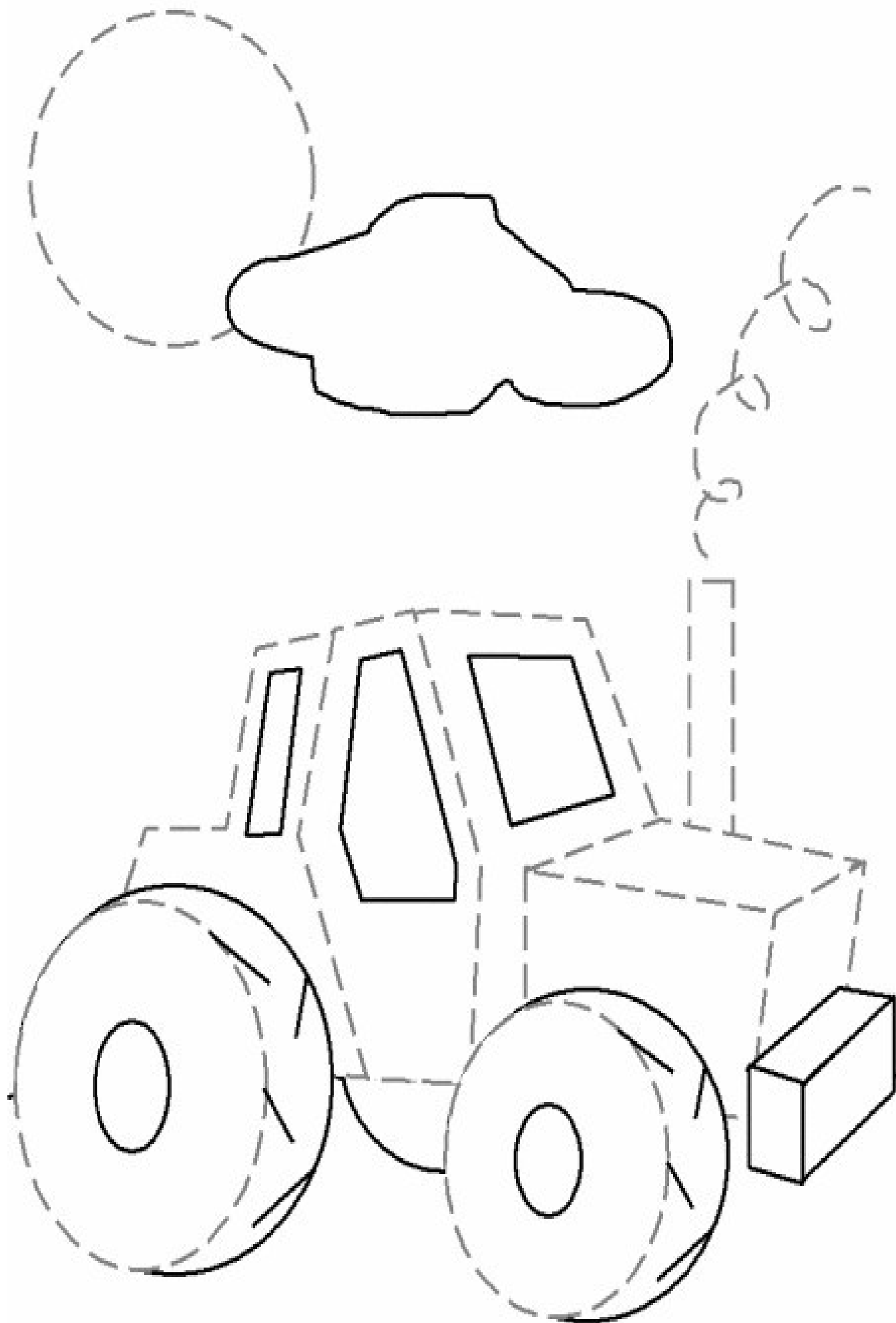

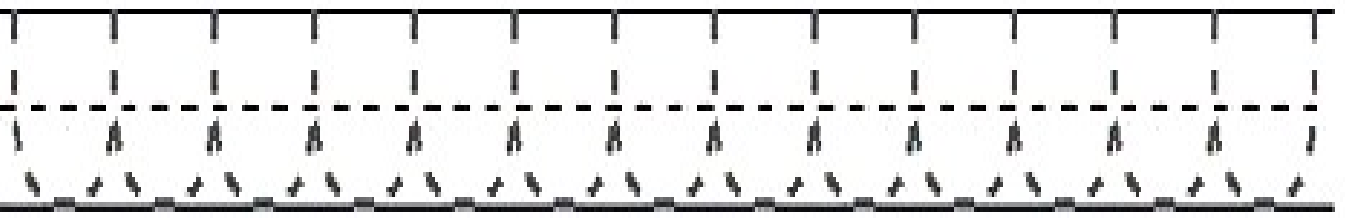
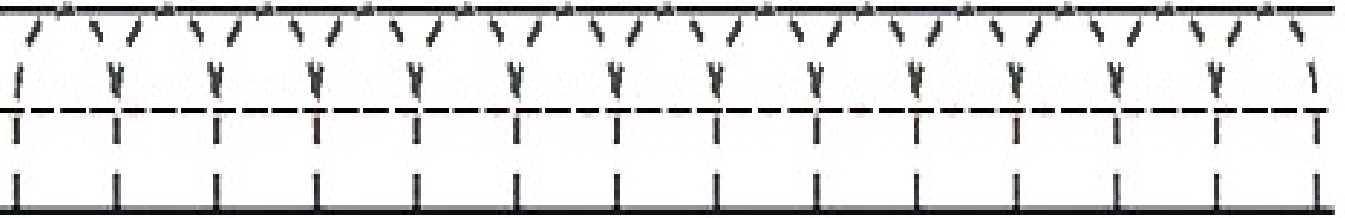
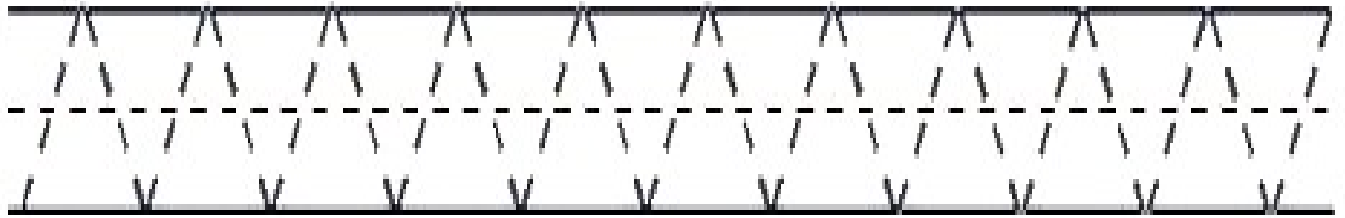
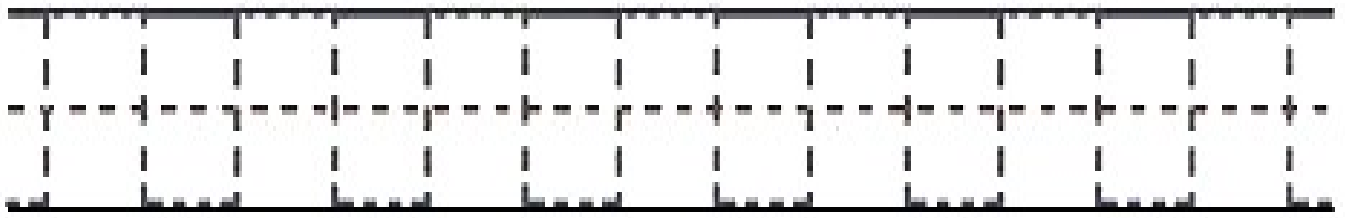
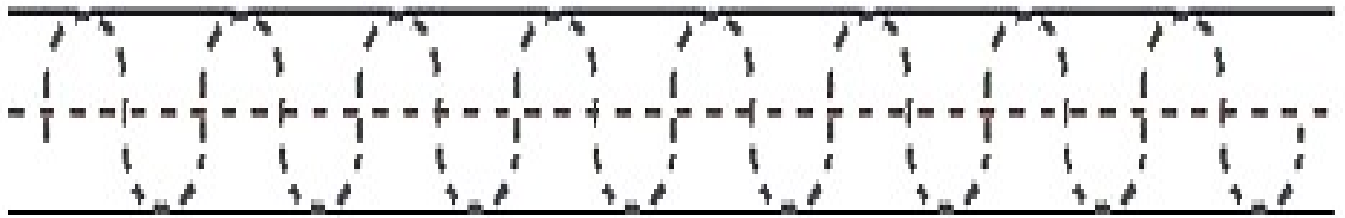

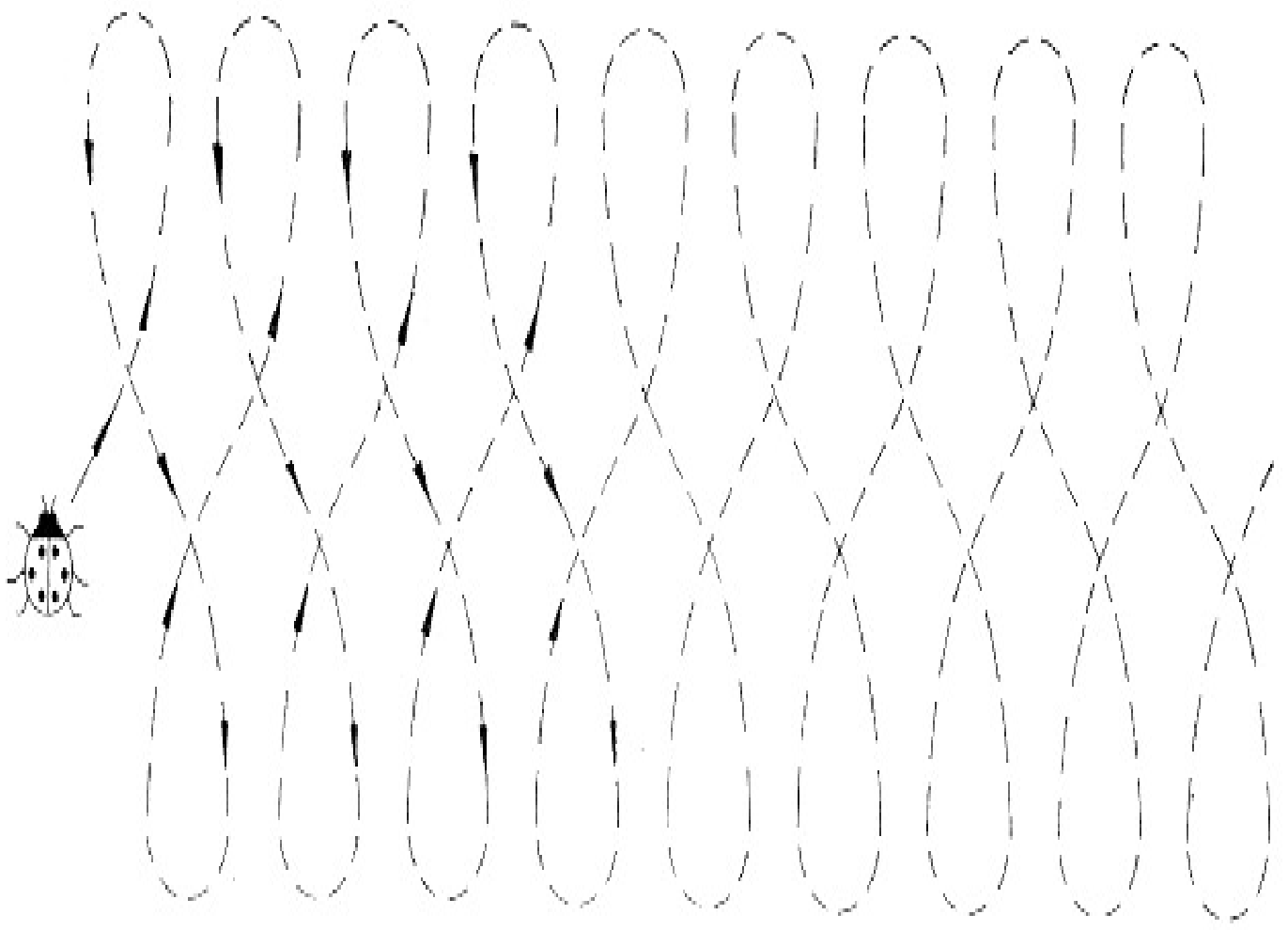

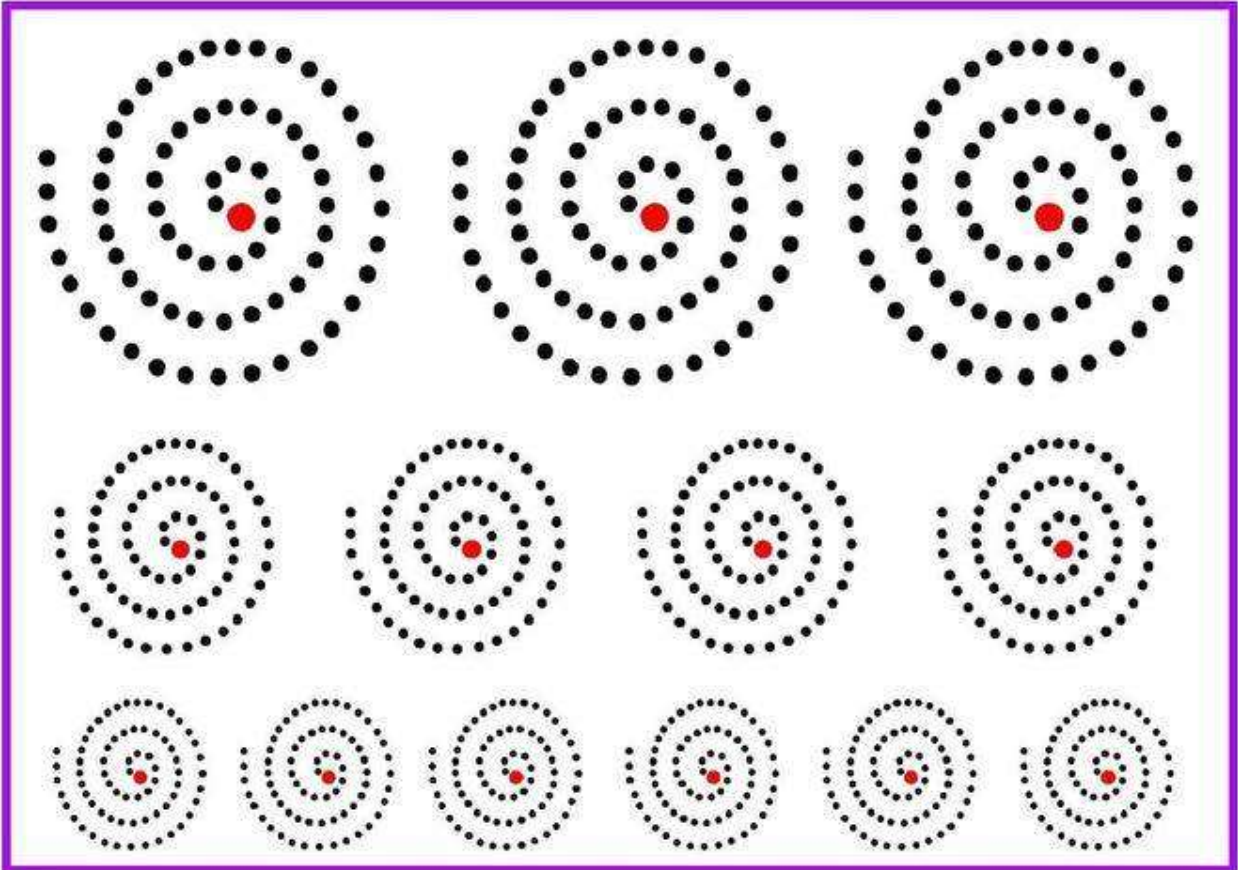

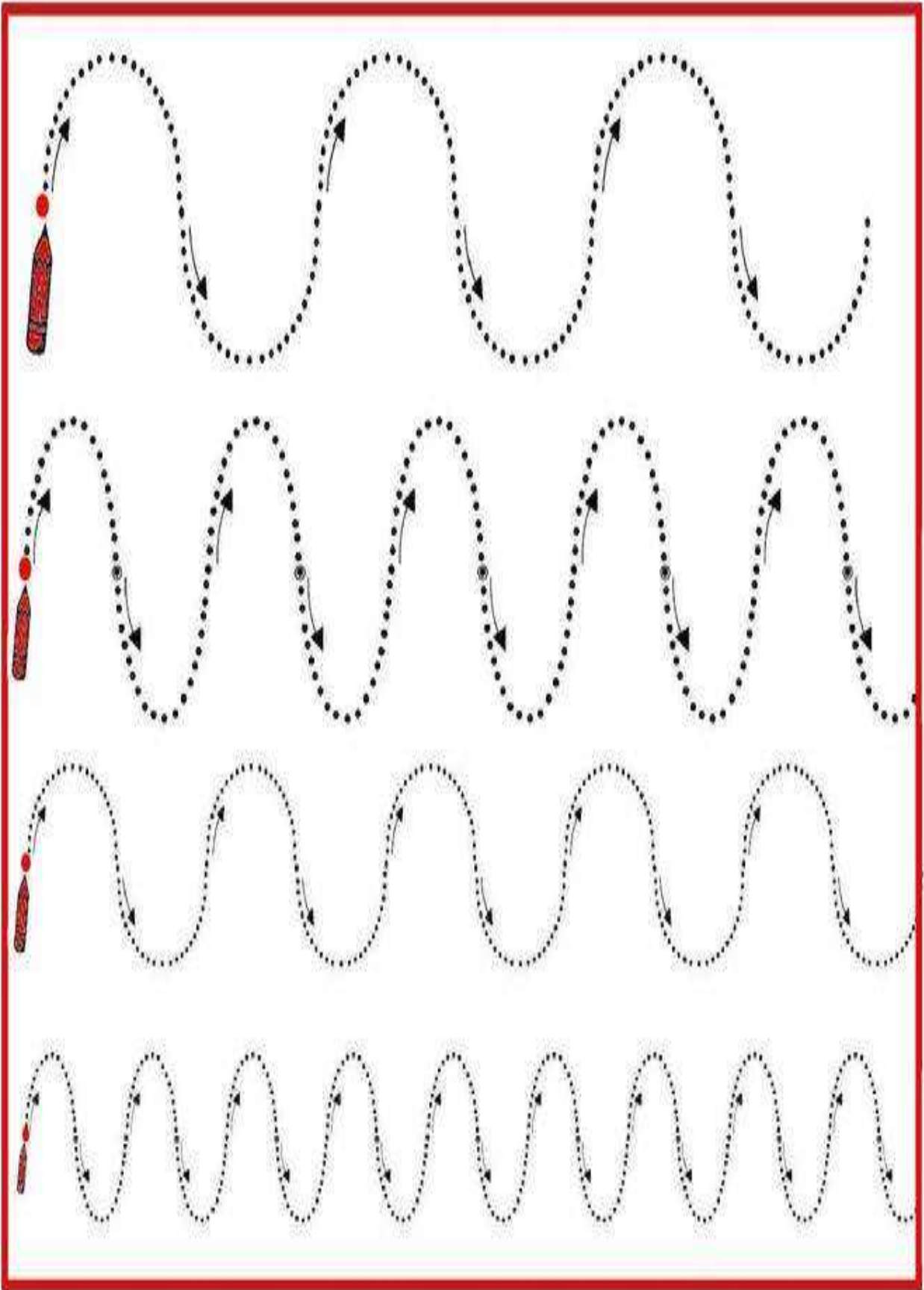

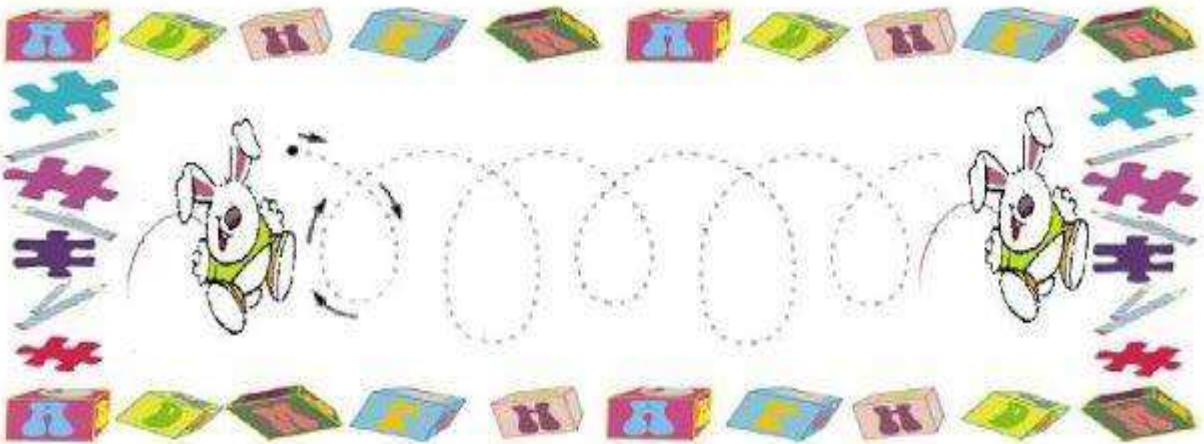
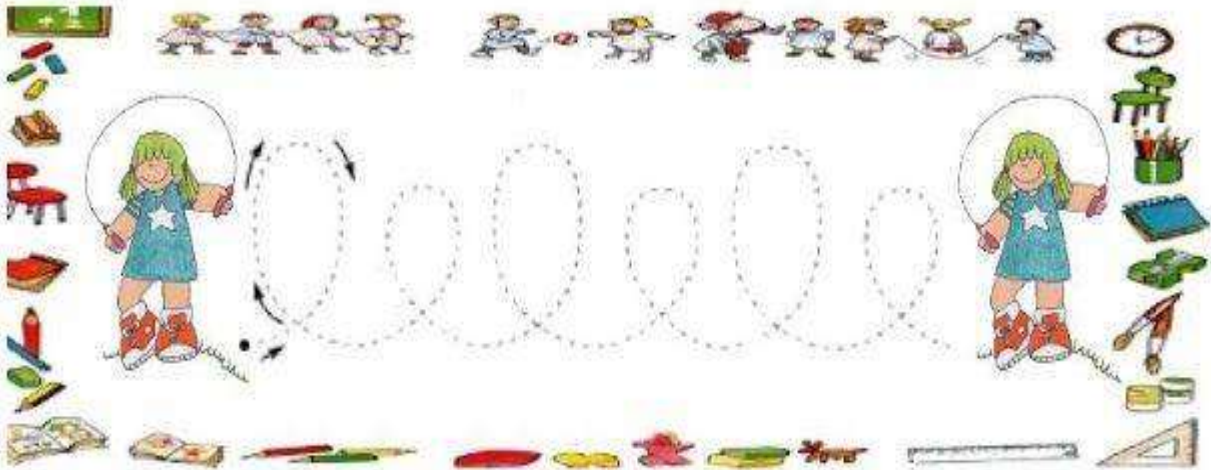
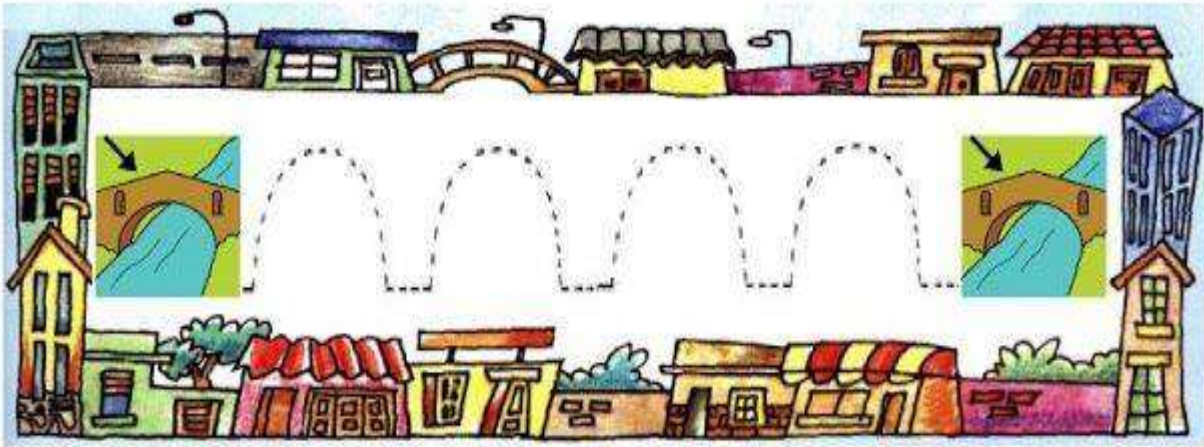

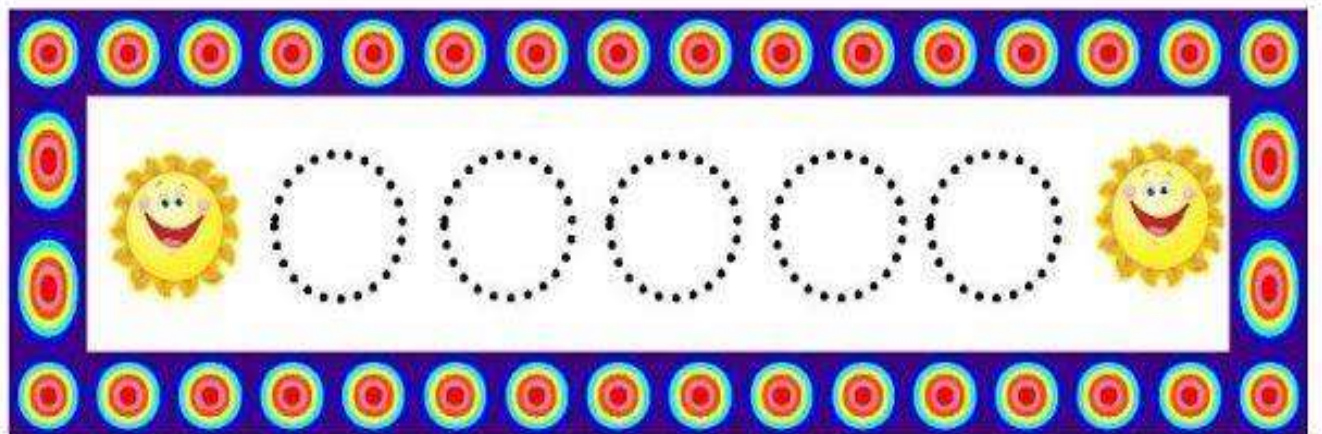
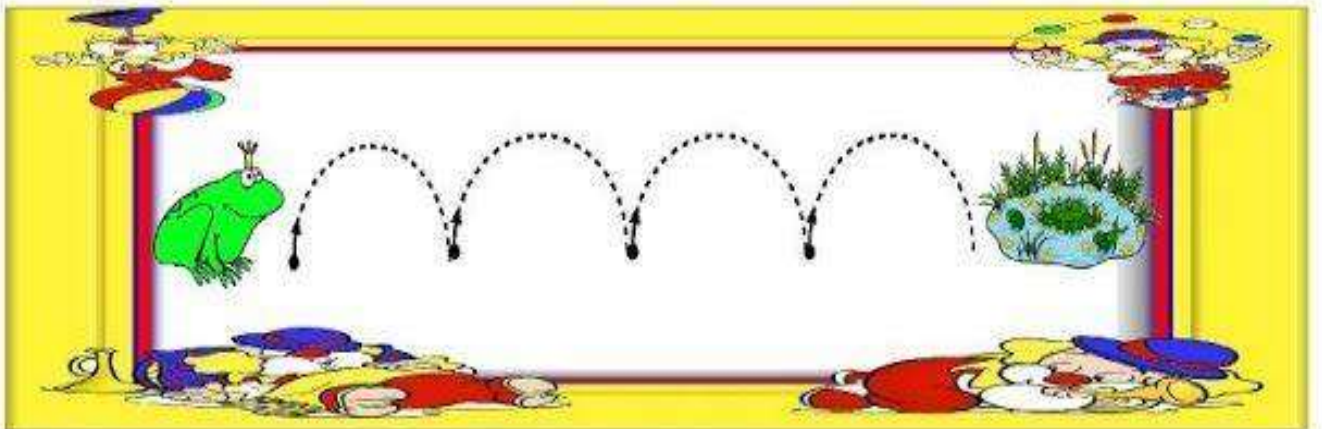
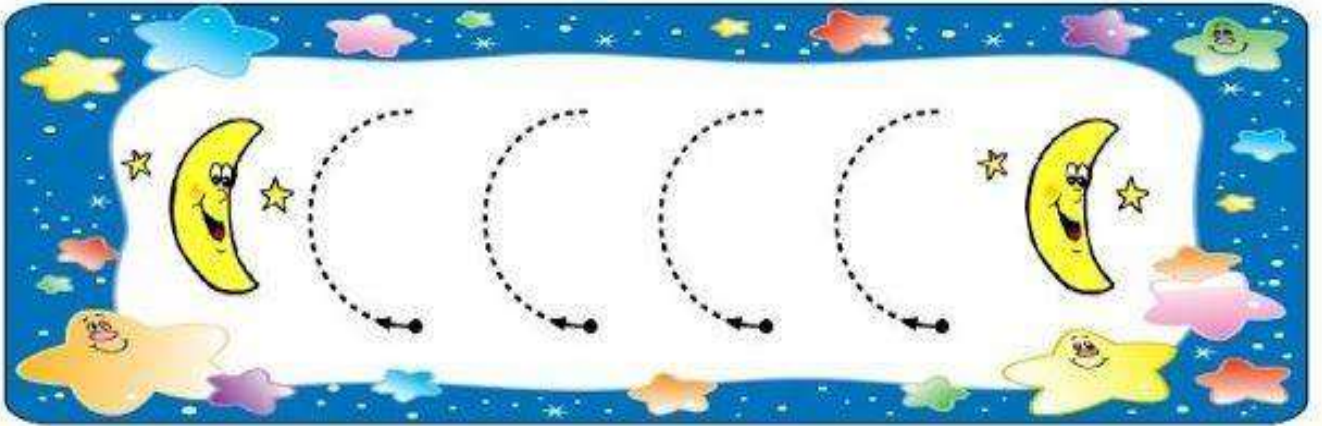
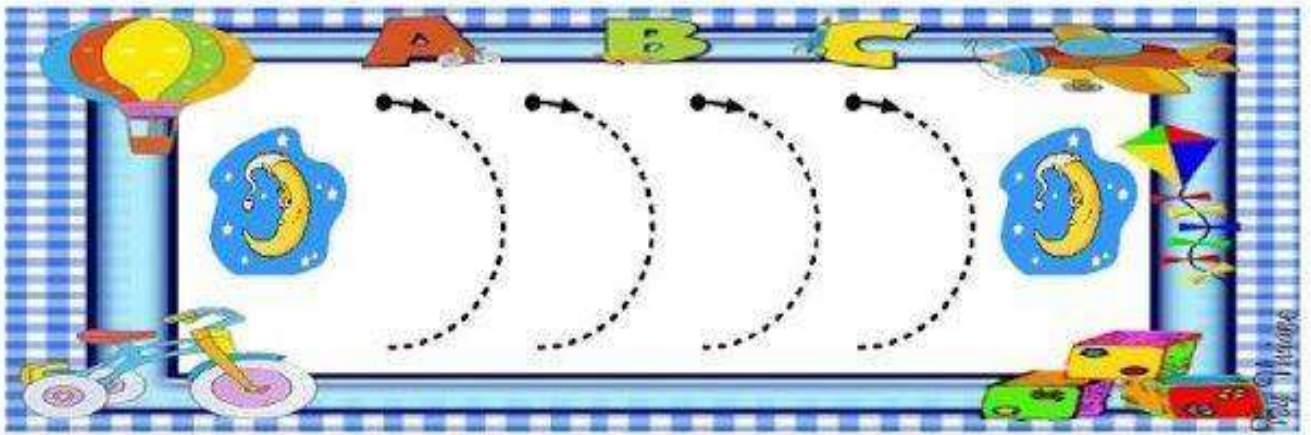

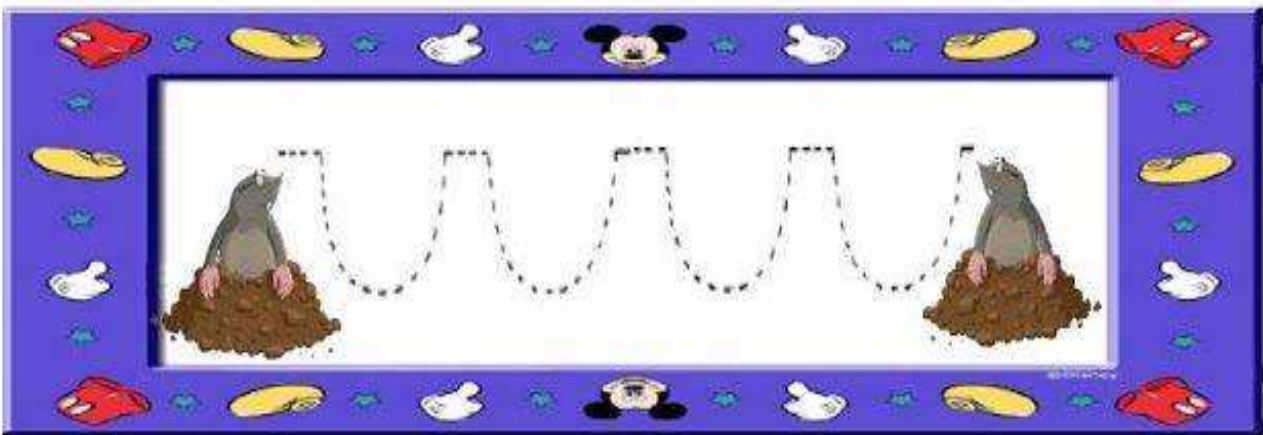
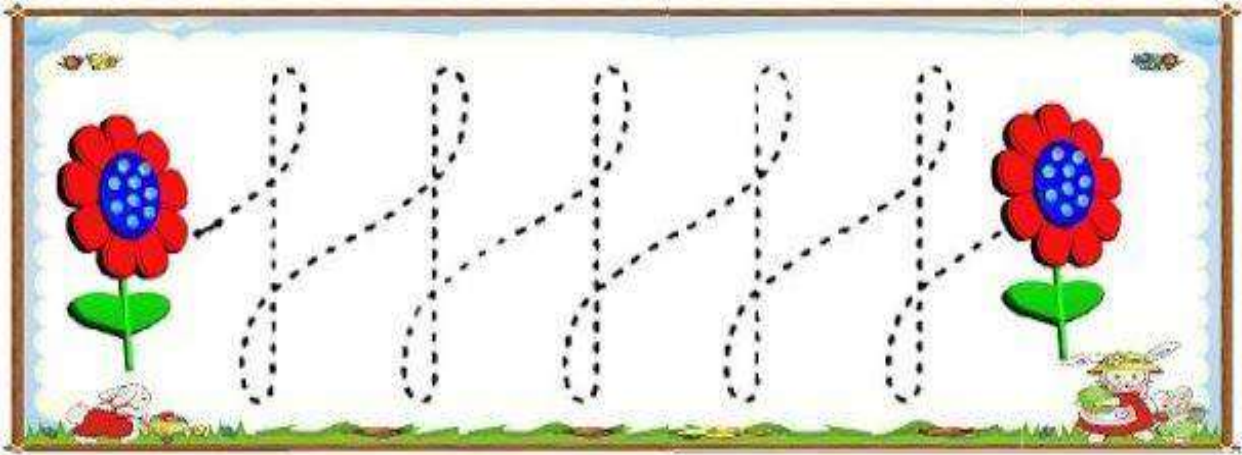
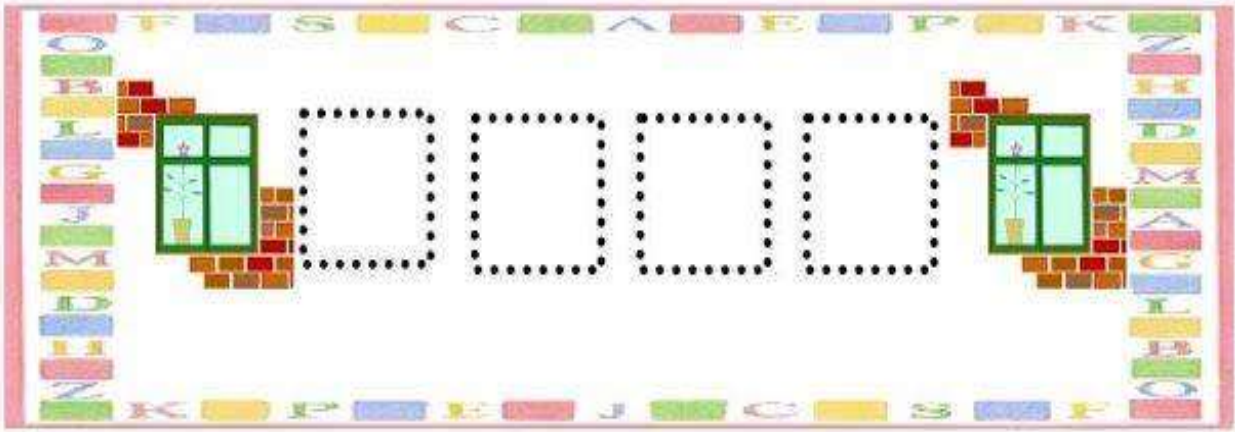

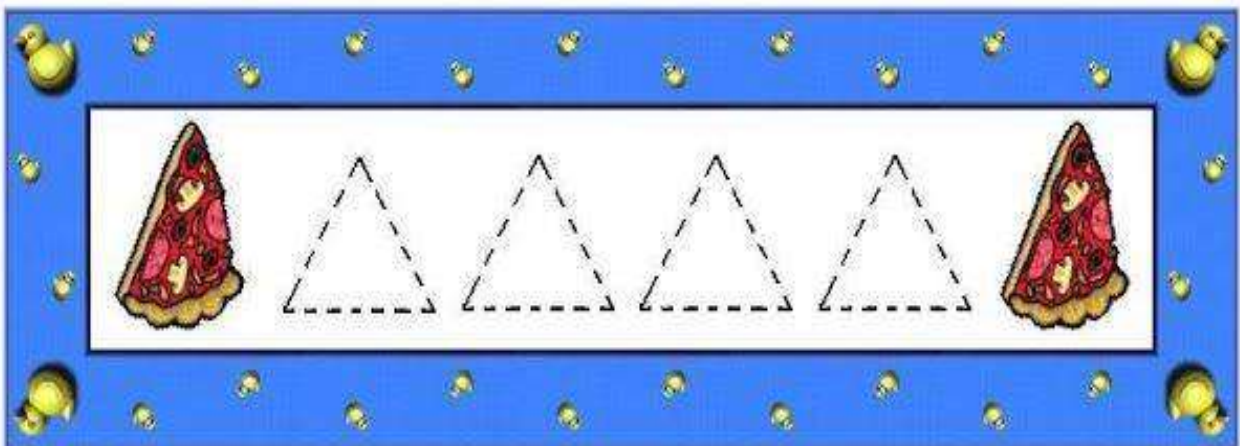
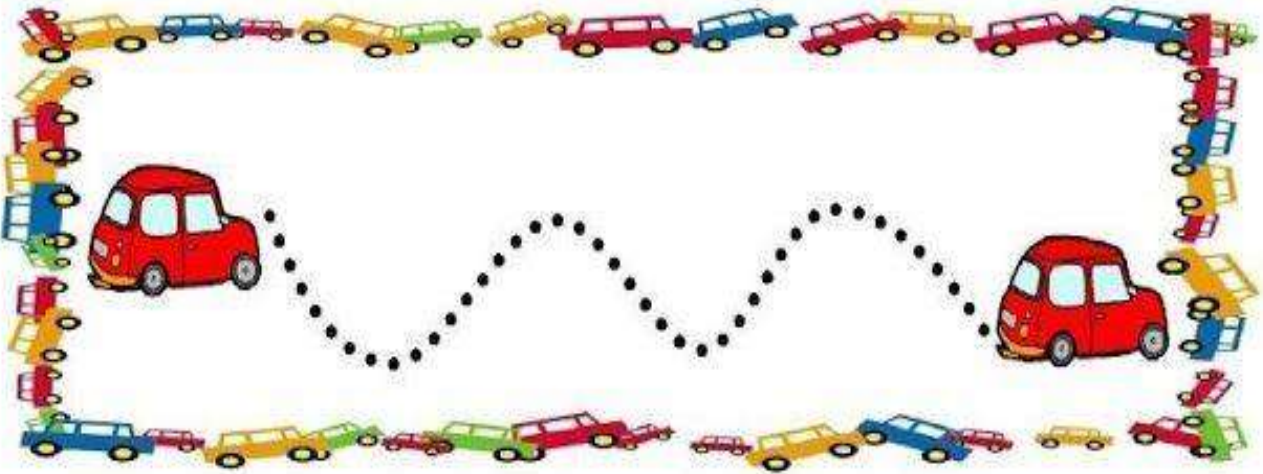
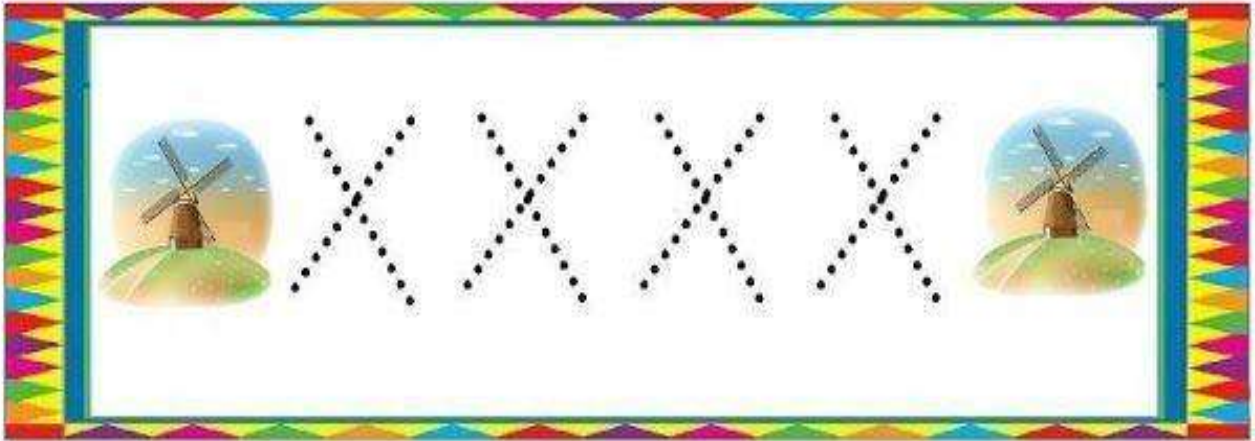
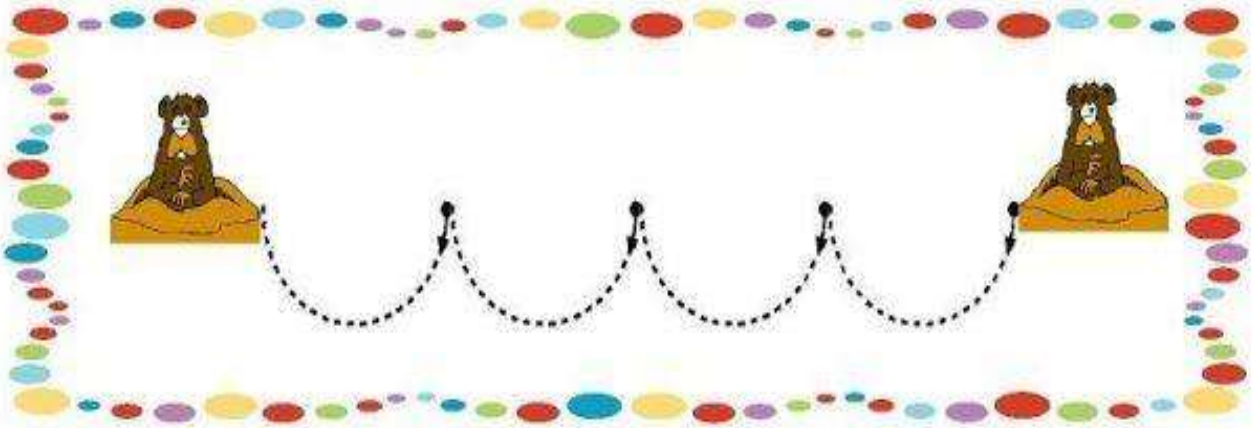

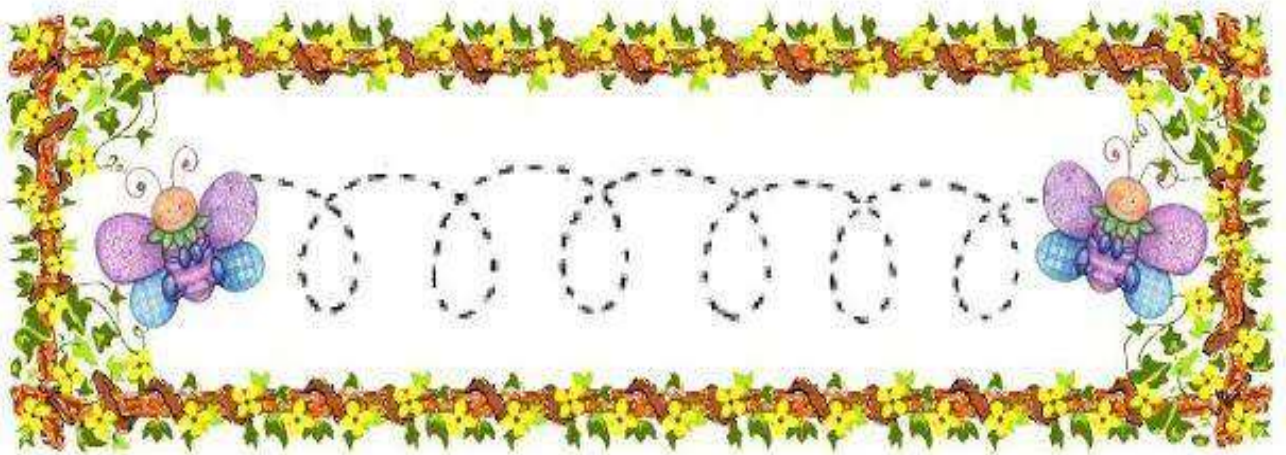
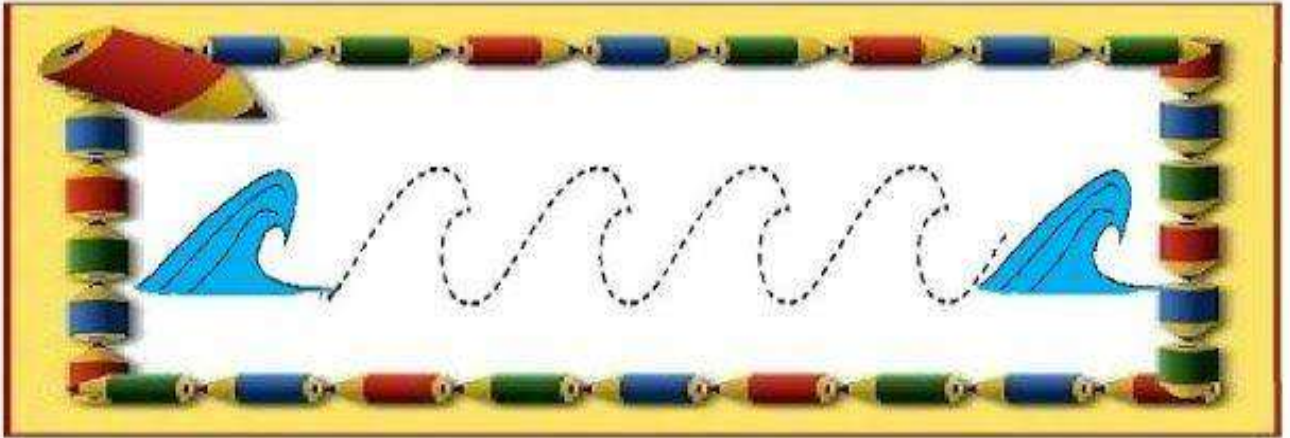
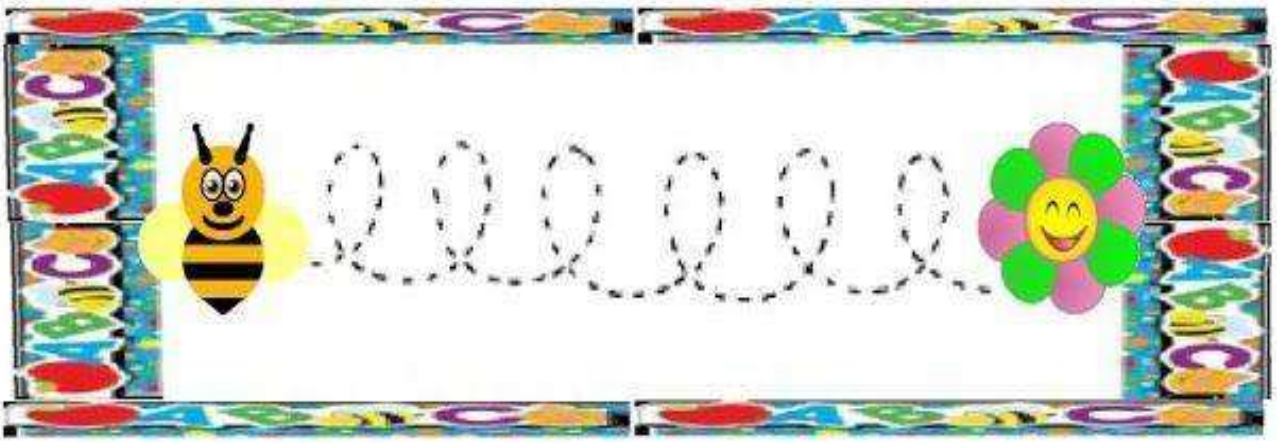

СПОЈИ ТАЧКИЦЕ ПА ОБОЈИ ДОБИЈЕНЕ СЛИЧИЦЕ

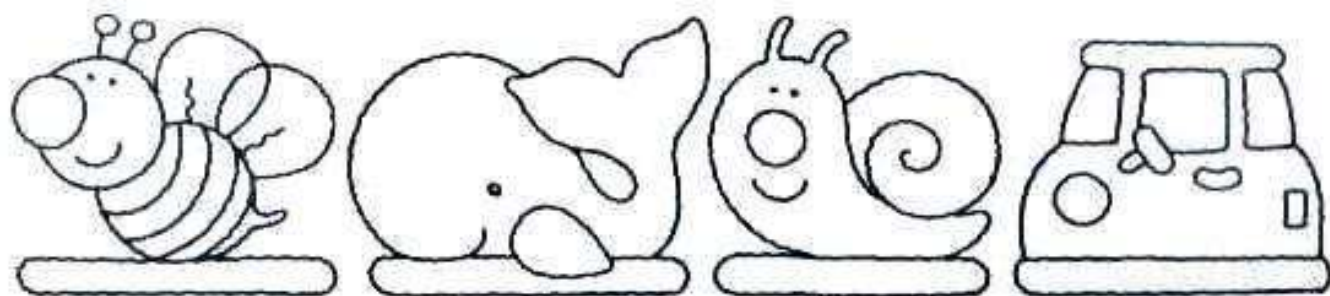
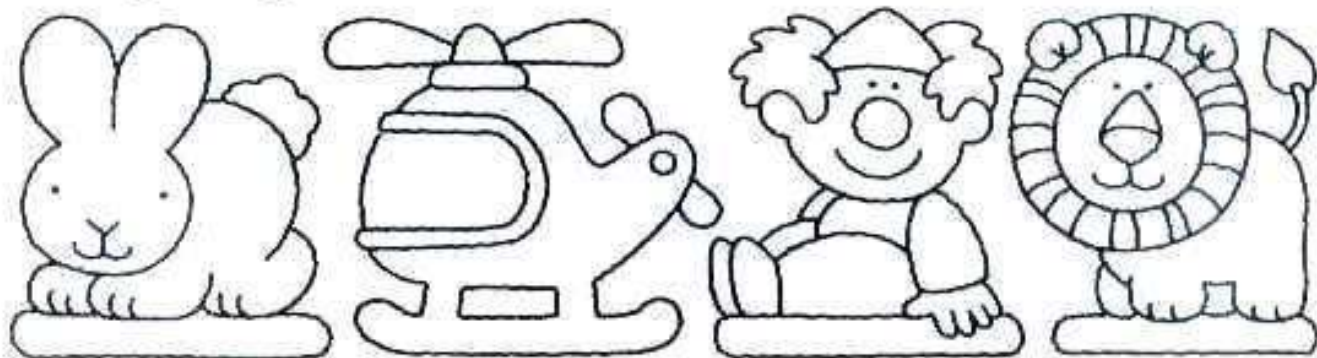
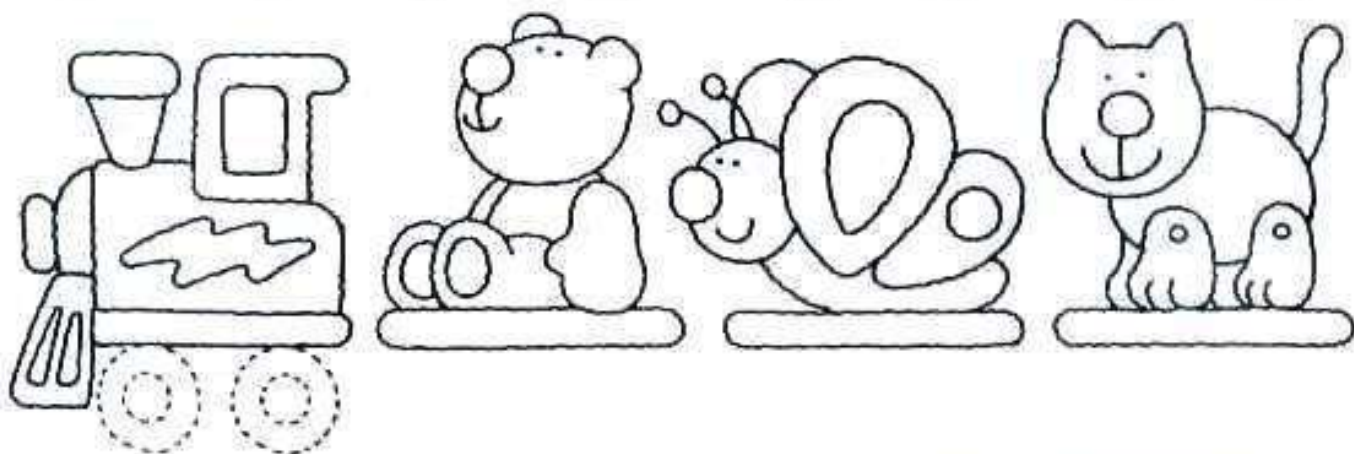
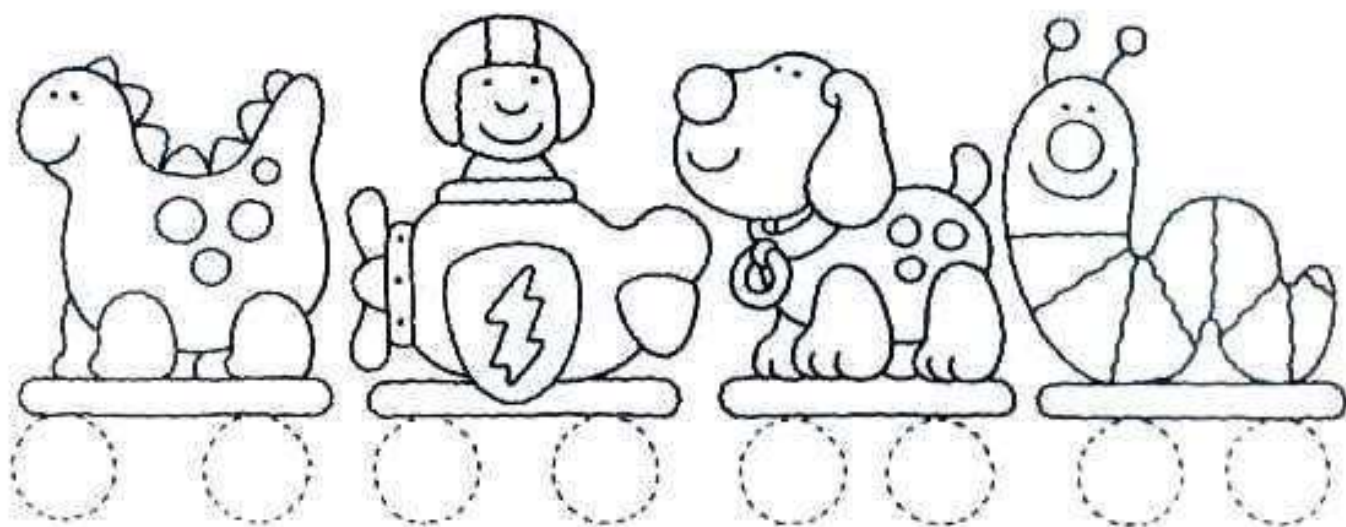

СПОЛИ ТАЧКИЦЕ ПА ОБОЈИ ДОБИЈЕНЕ СЛИЧИЦЕ

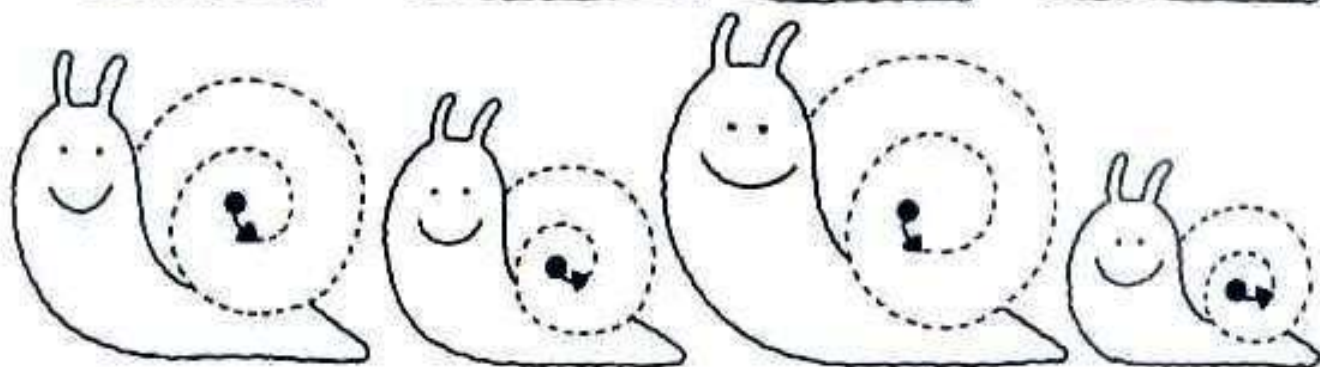
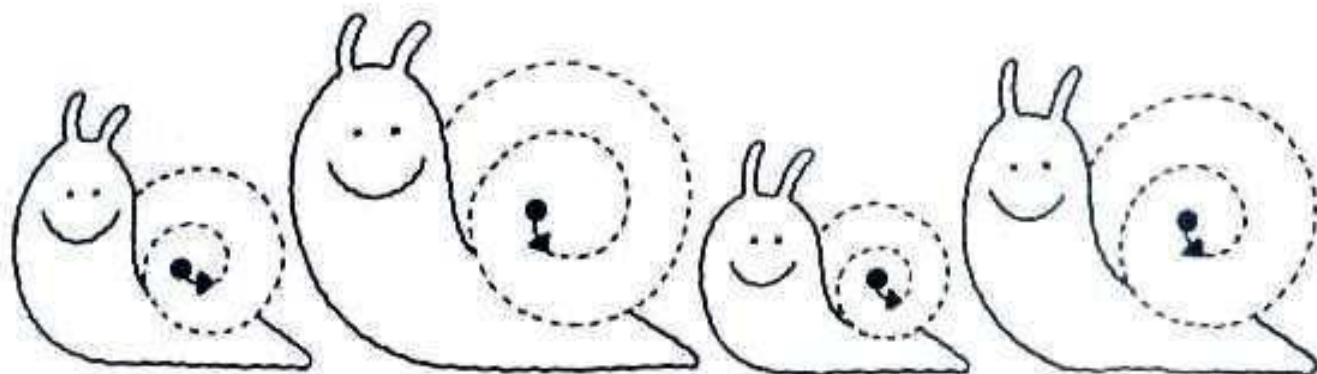
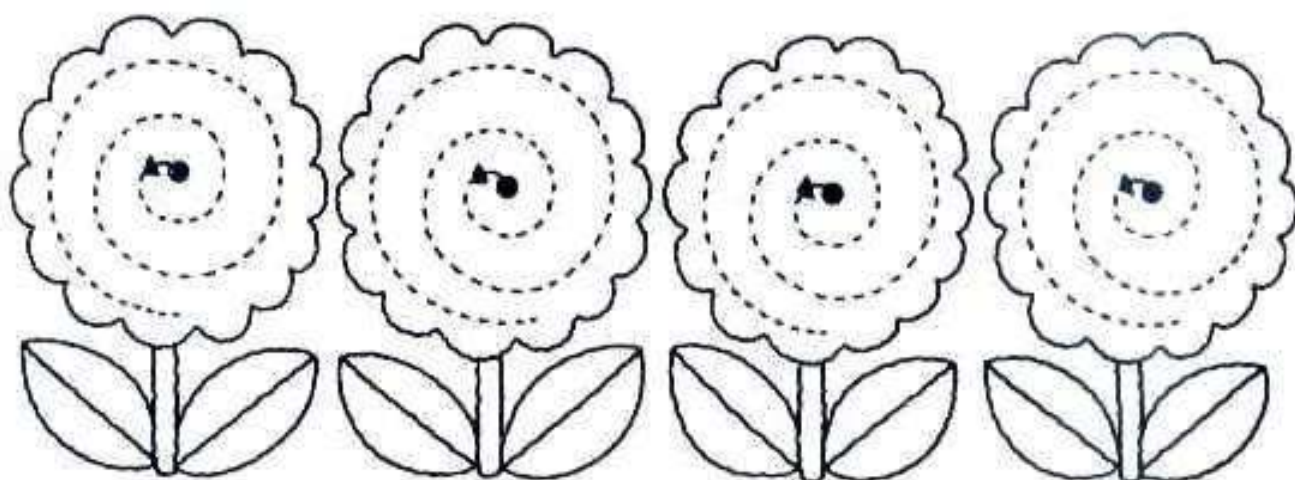
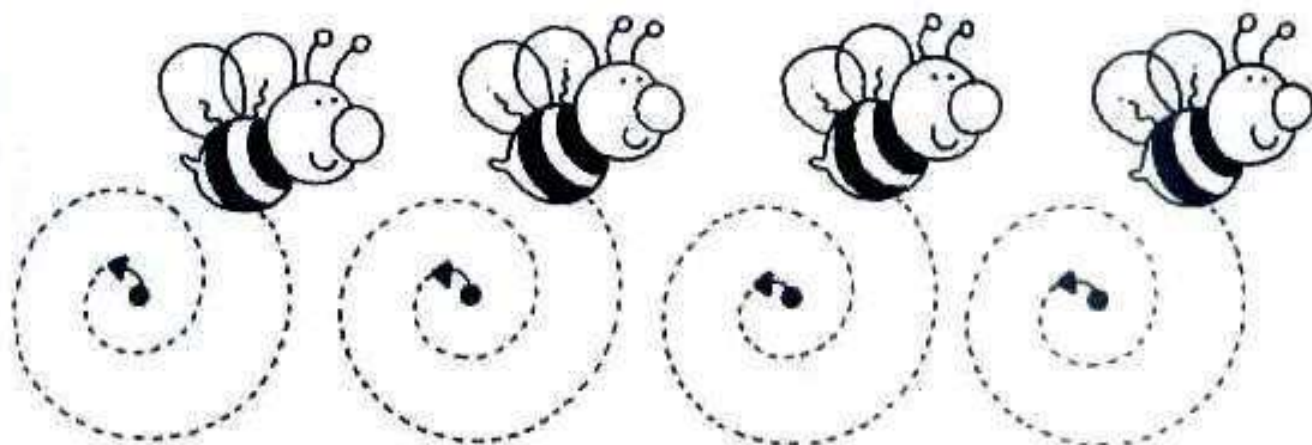

СПОЛИ ТАЧКИЦЕ ПА ОБОЛИ ДОБИЈЕНЕ СЛИЧИЦЕ

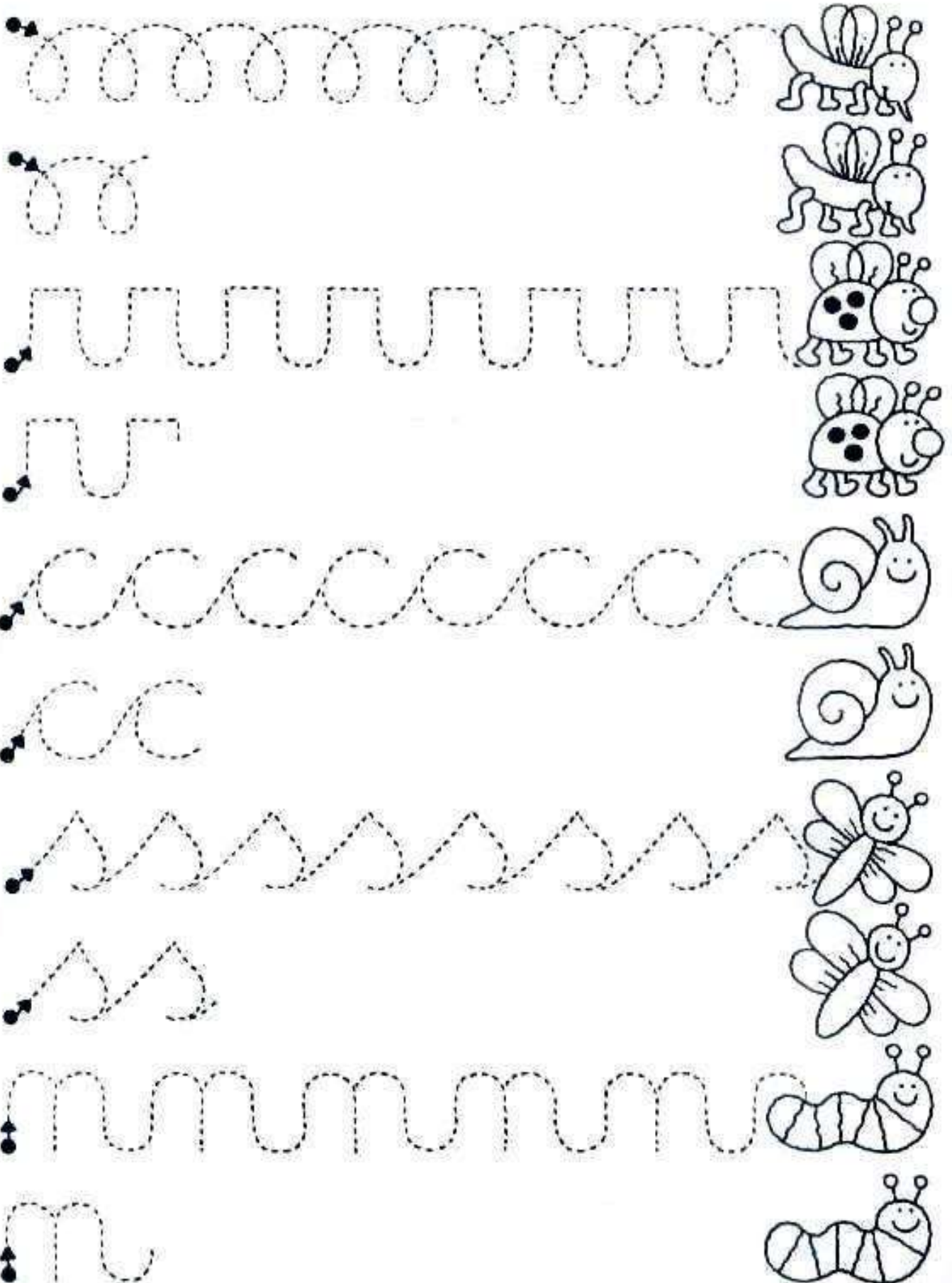

СПОЛИ ТАЧКИЦЕ ПА ДОЦРТАЈ ШАРЕ НА
ЧАРОБНОМ ТЕПИХУ И ОБОЈИ ДОБИЈЕНУ СЛИКУ



СПОЛИ ТАЧКИЦЕ ПА ДОЦРТАЈ ШАРЕ
НА КАПАМА И ОБОЈИ ДОБИЈЕНЕ СЛИЧИЦЕ

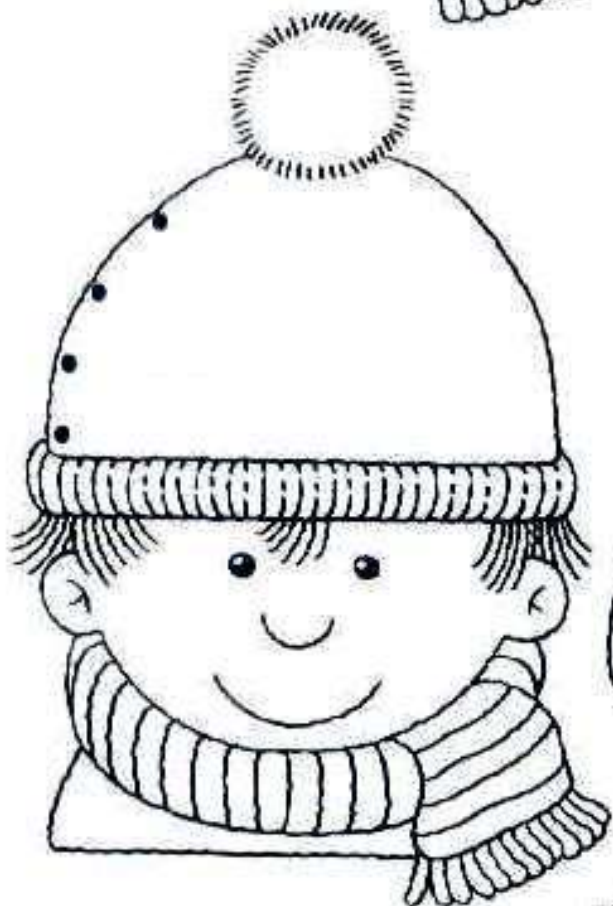

СПОЈИ ТАЧКИЦЕ ПА ОБОЈИ ДОБИЈЕНУ СЛИКУ

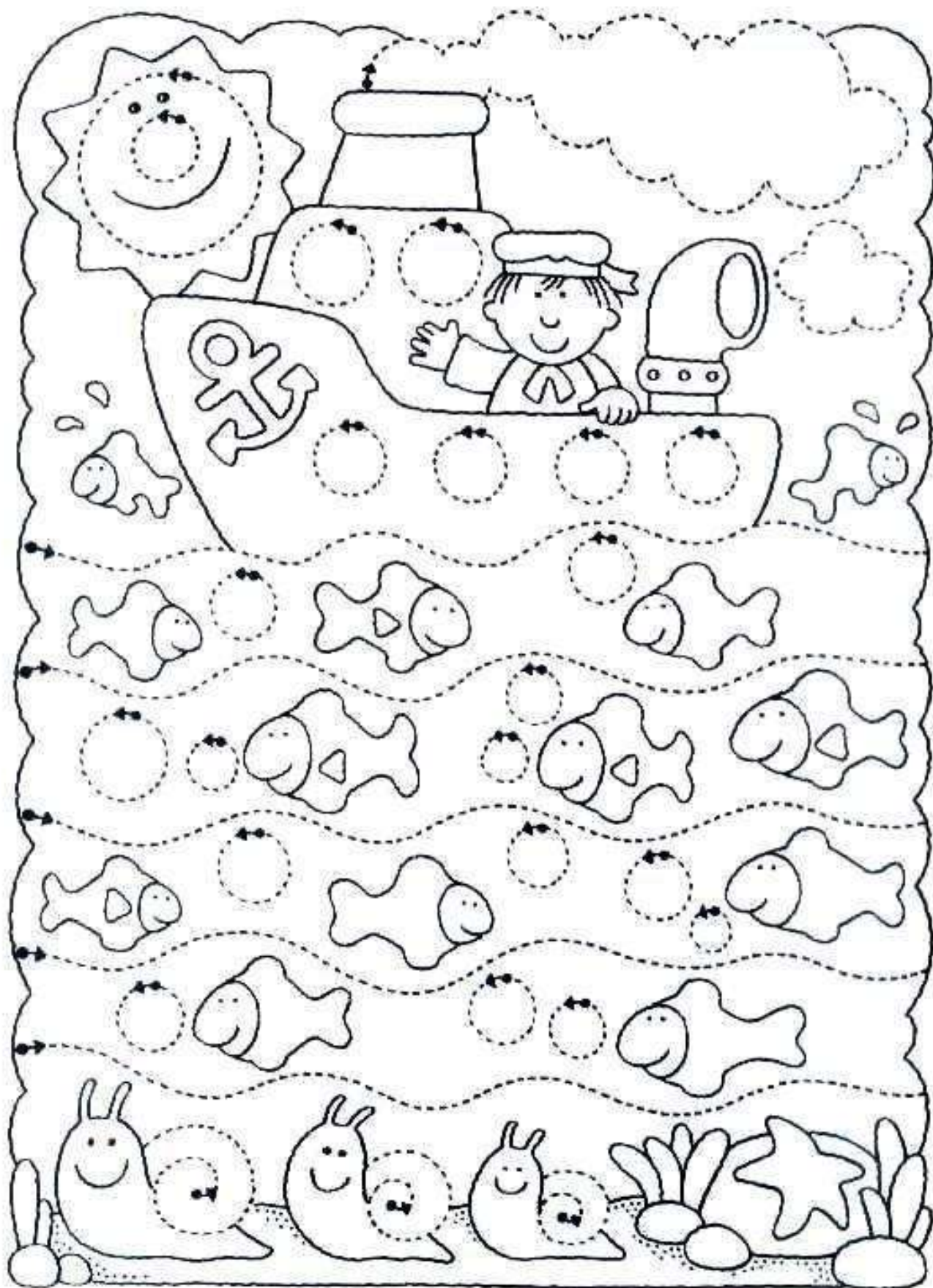

СПОЈИ ТАЧКИЦЕ ПА ОБОЈИ ДОБИЈЕНЕ СЛИЧИЦЕ



Нацртај осмехе и украси торту

Име: _____

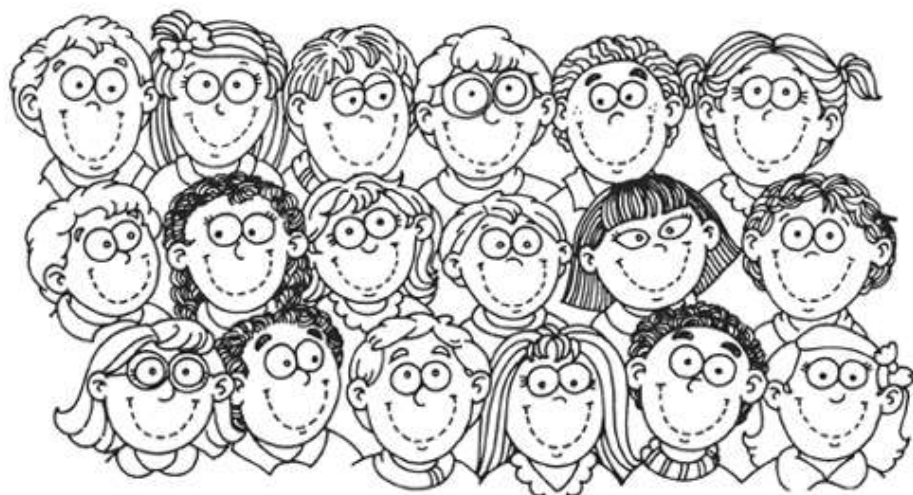

Име: _____

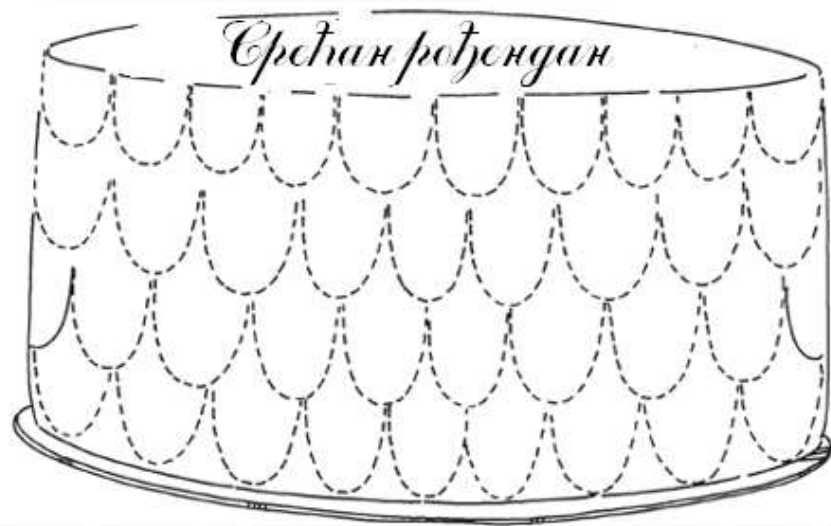

Нацртај осмехе и украси торту

Име: _____

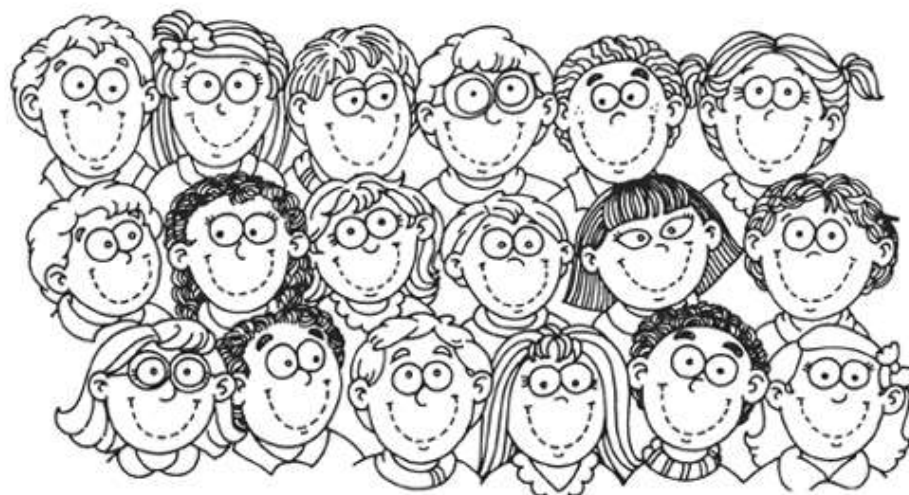

Име: _____

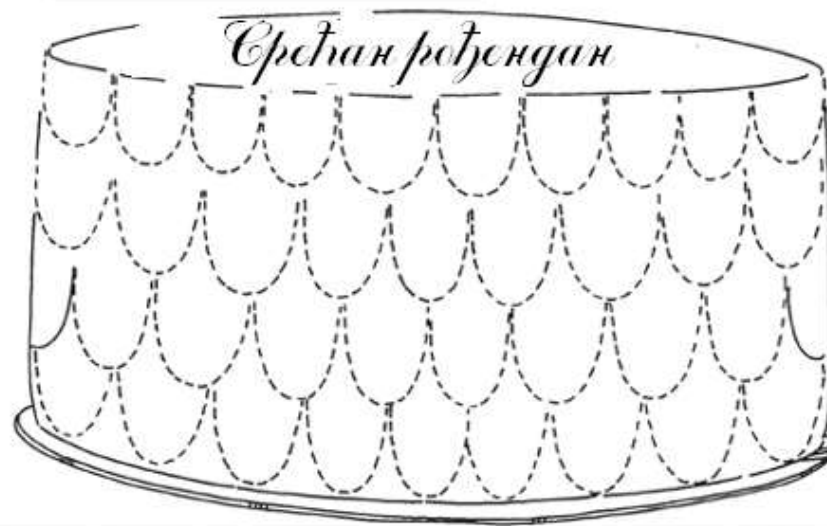

o o o o

f f f f

g g g g

n n n n

A A A A

a a a a

u u u u

o o o o

G G G G

Q Q Q Q

w w w w

z z z z

x x x x

l l l l

u u u u

u u u u

s s s s

t t t t t t

x x x x x x

z z z z

o o o o

y y y y

c c c c

o o o o

c c c c

n n n n

l l l l

m m m m

z z z z

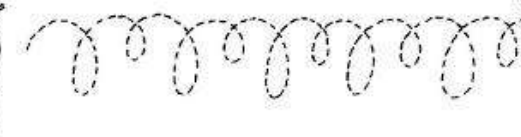
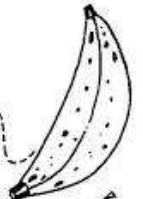
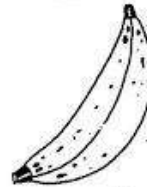
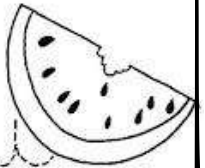
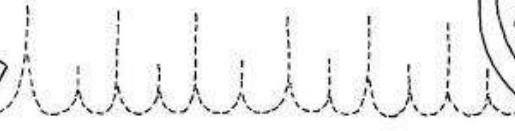
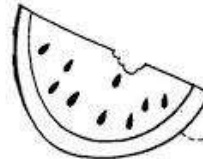
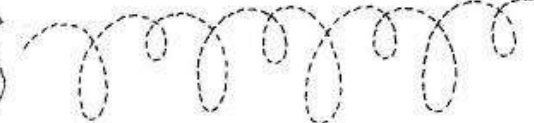
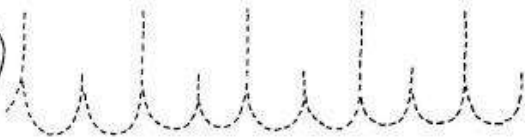

- Подебљај бројеве по тачкама.

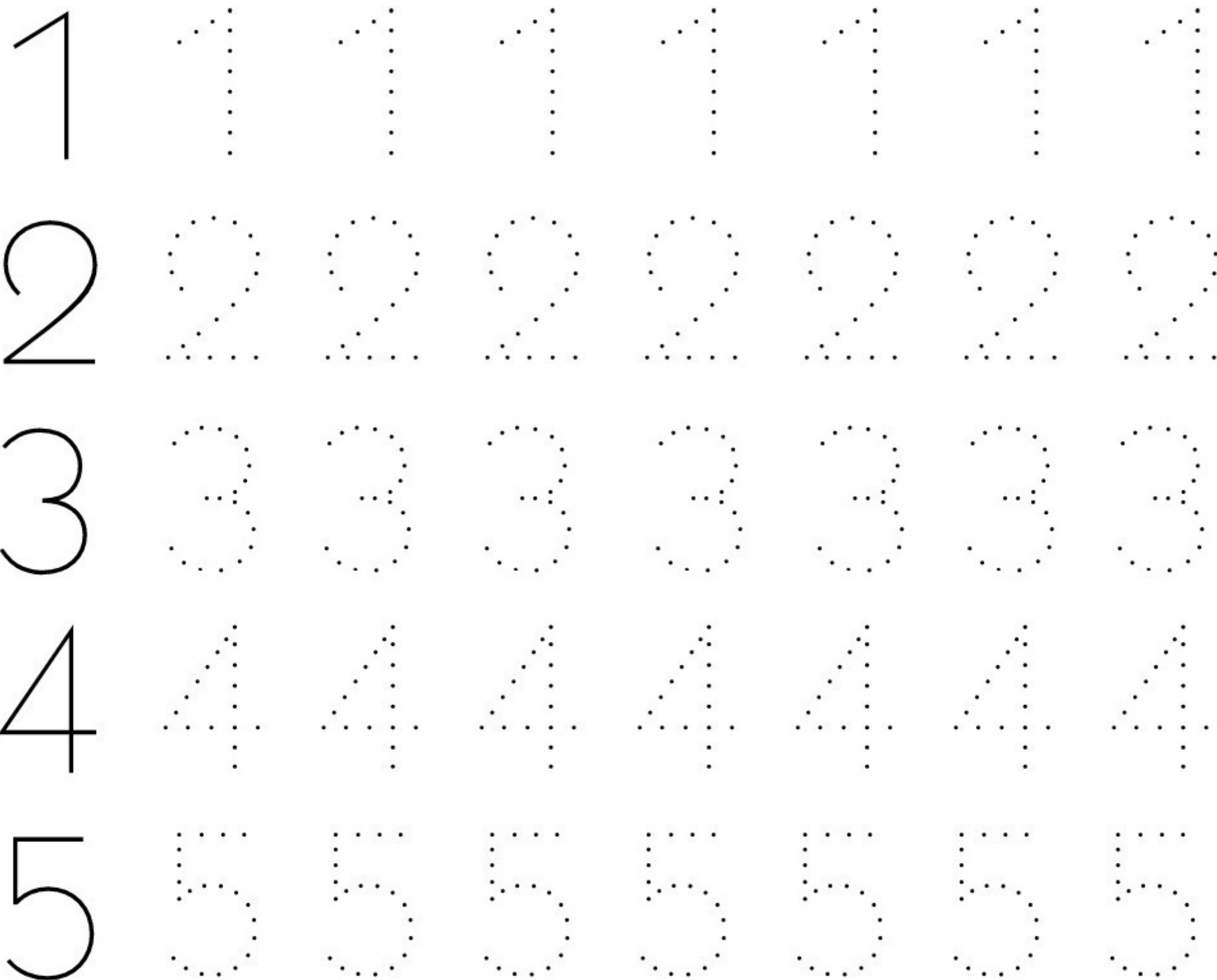

- Доцртај и обој.

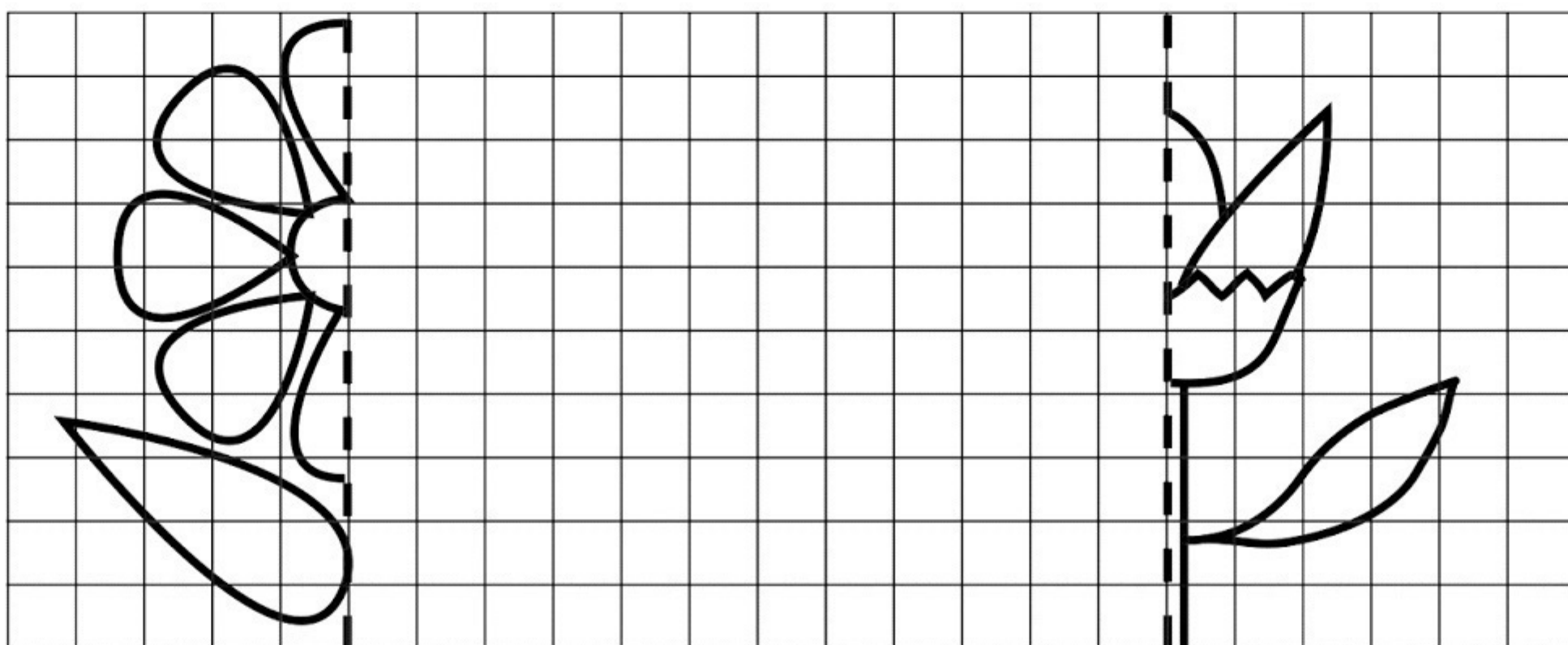

- Подебљај по тачкама и обој.

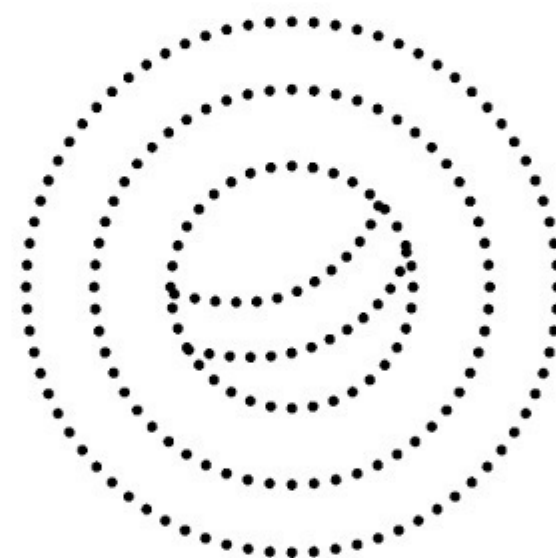
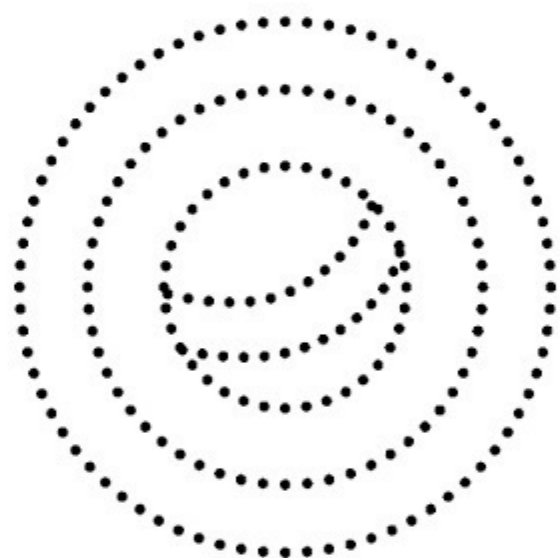
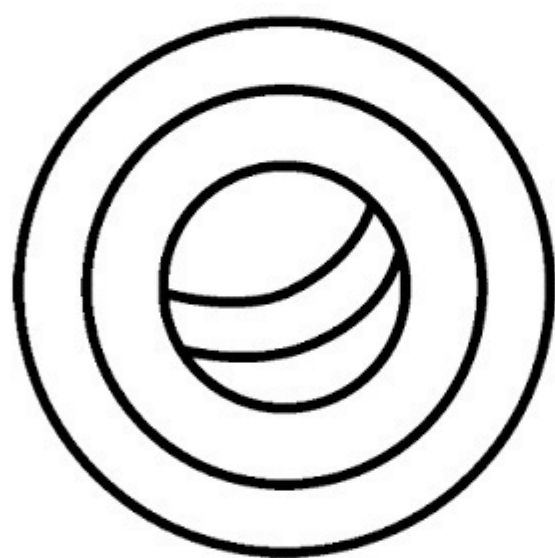
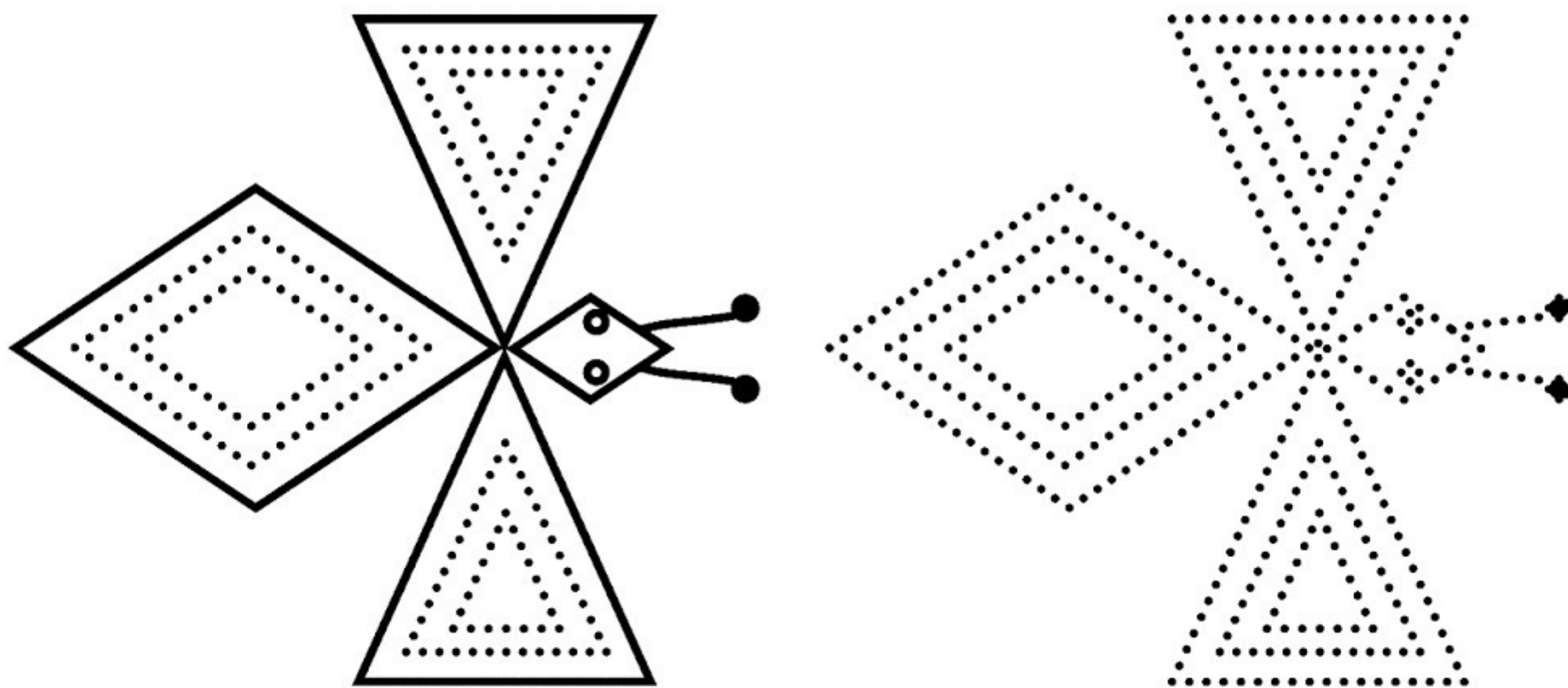

- Доцртај и обој.

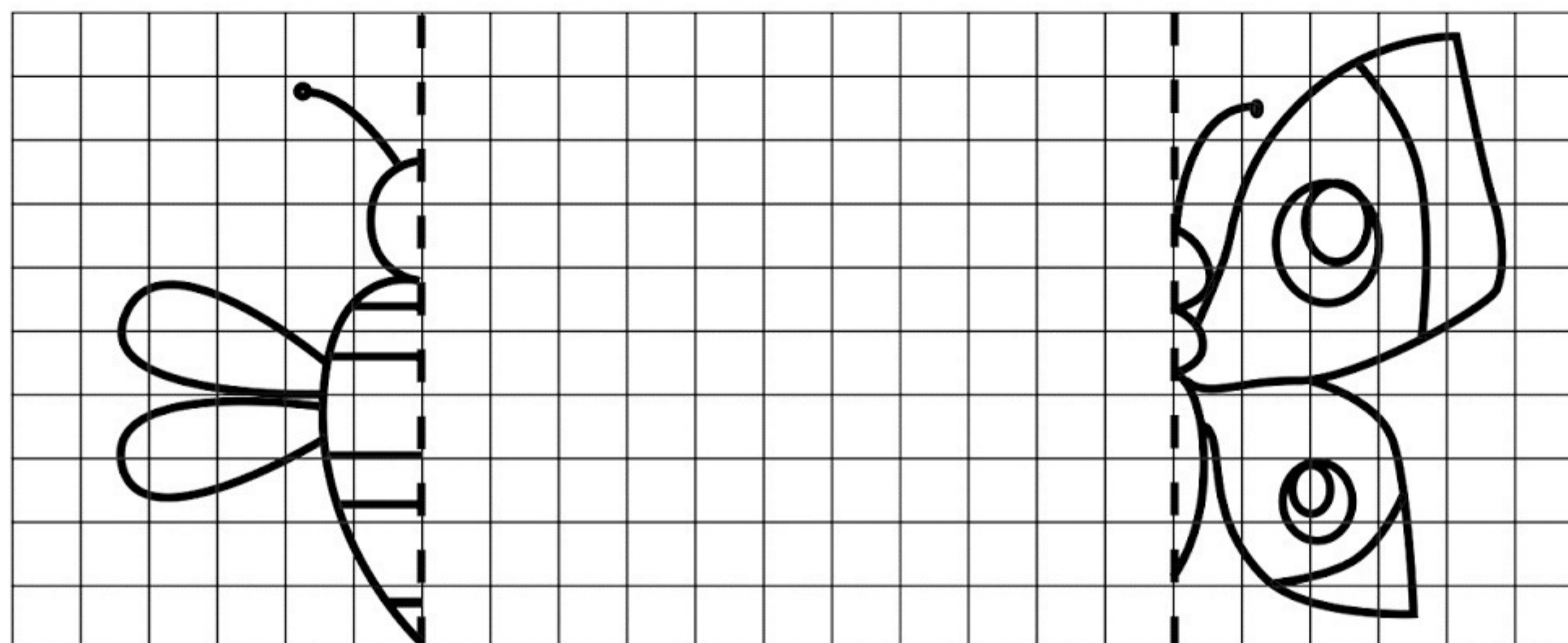

- Подебљај бројеве по тачкицама.

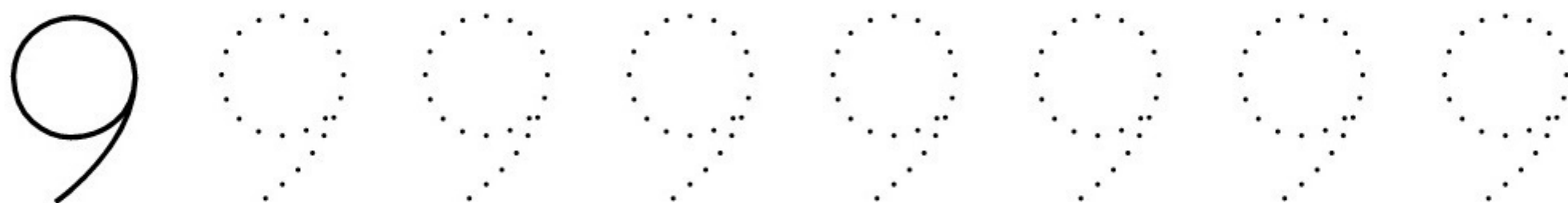

- Подебљај, доцртај и обој.



- Подебљај и обој животиње.

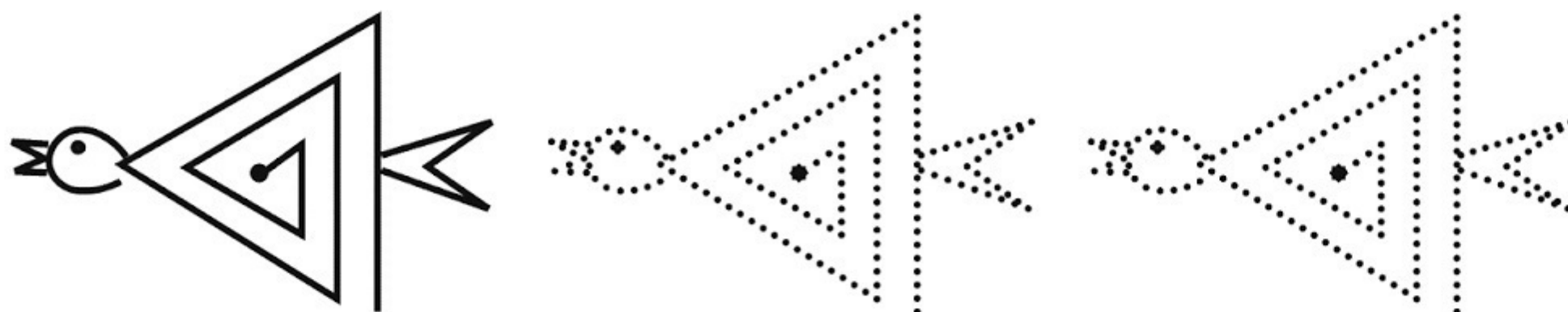

- Подебљај, доцртај и обој.

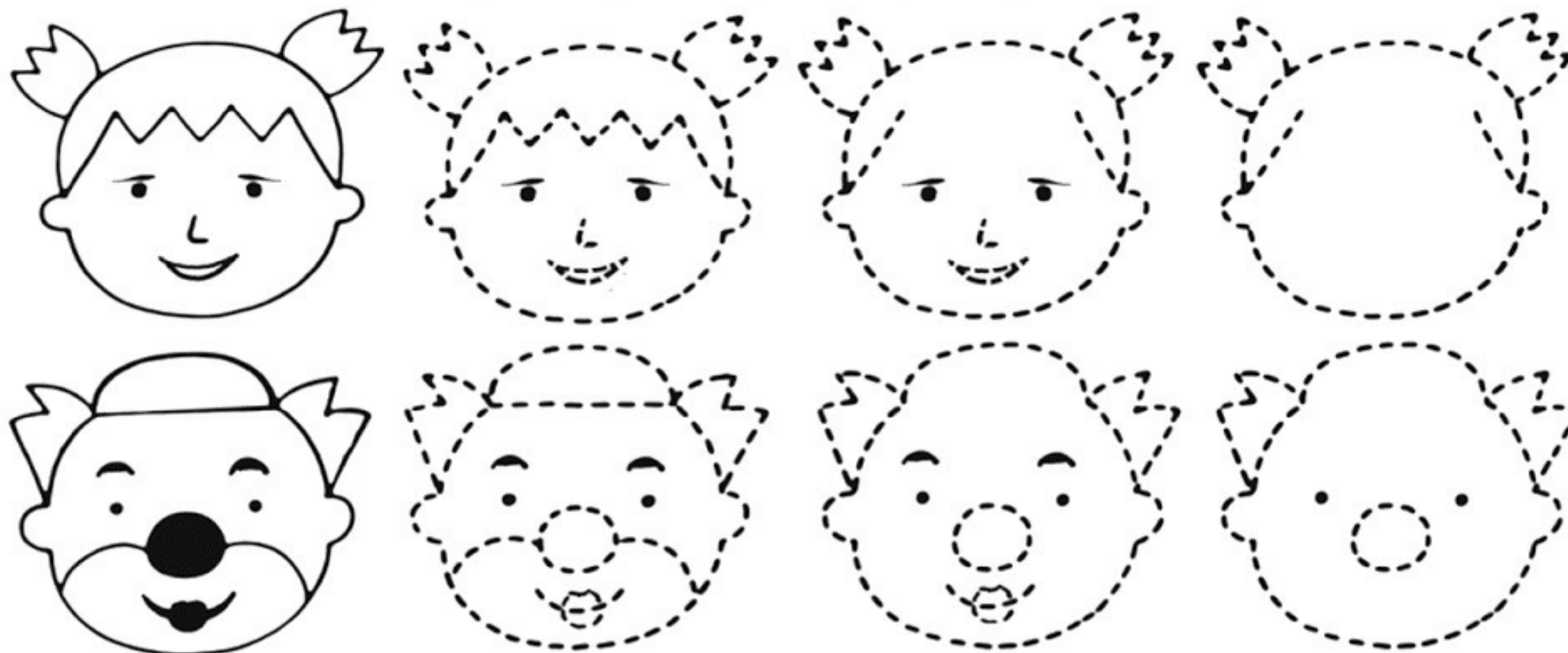

- Подебљај и обој принцезу.
Изброј колико има великих балона од сапунице.

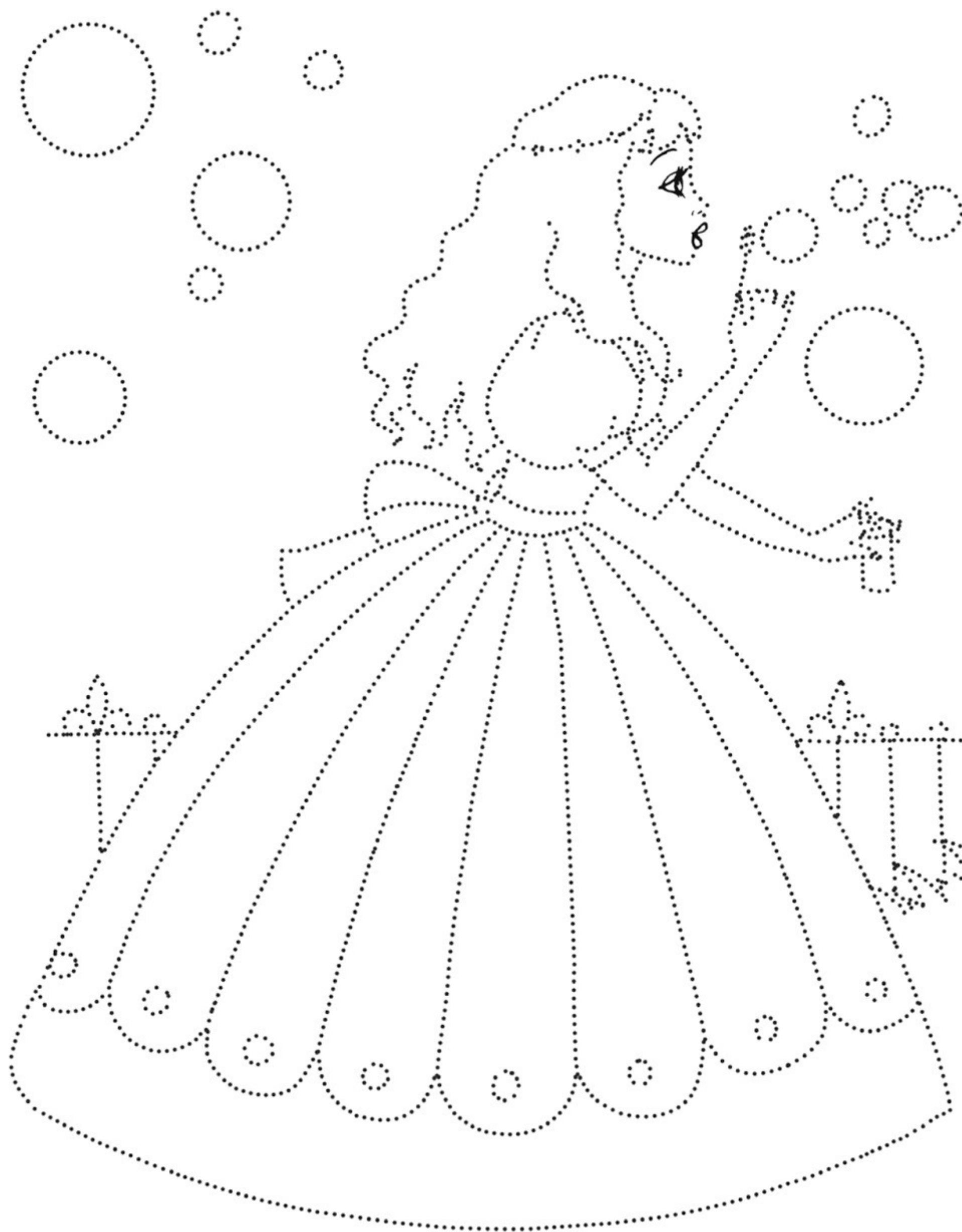

- Доврши цртеж као што је започето разнобојним оловкама.

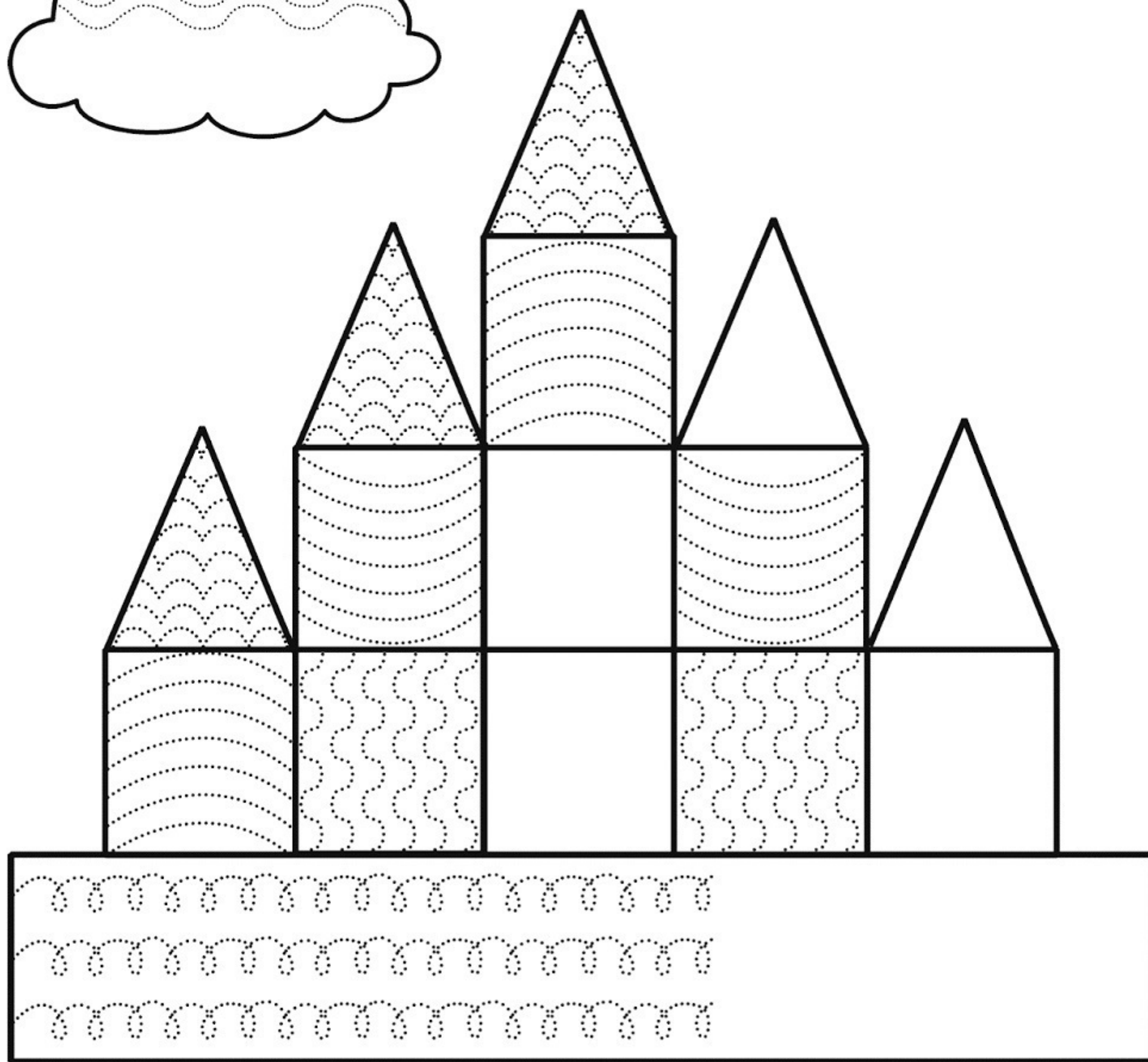
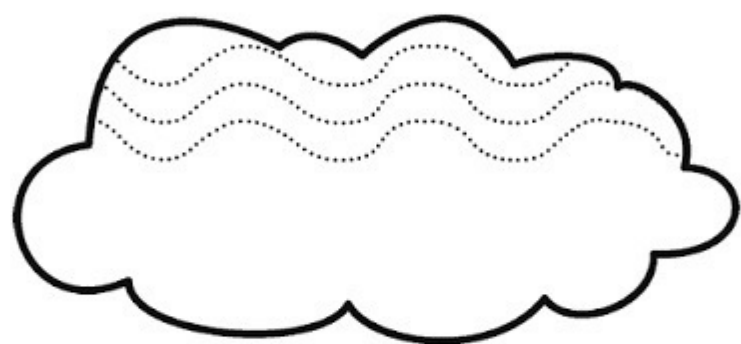
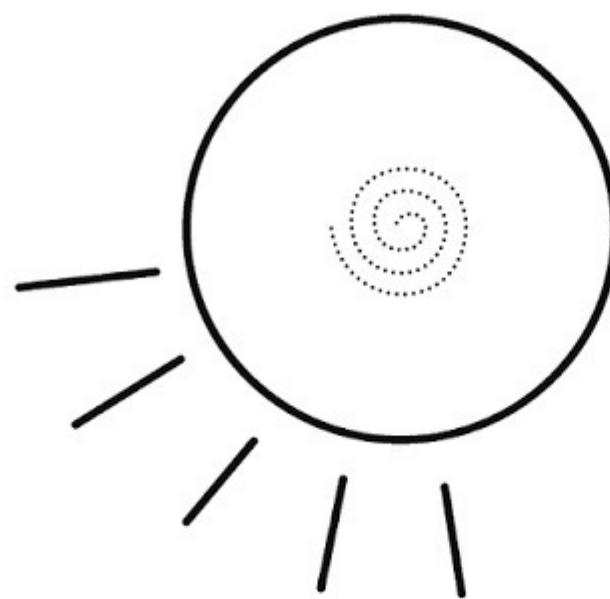
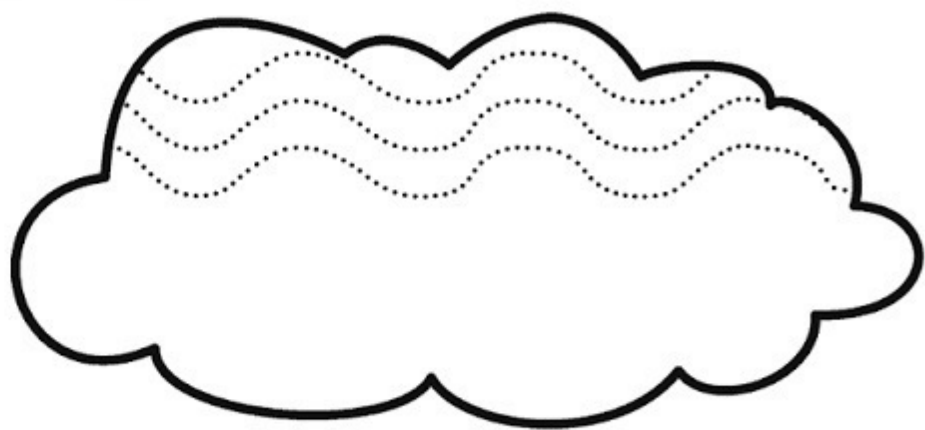

- Пронађи и обој три иста лептира.

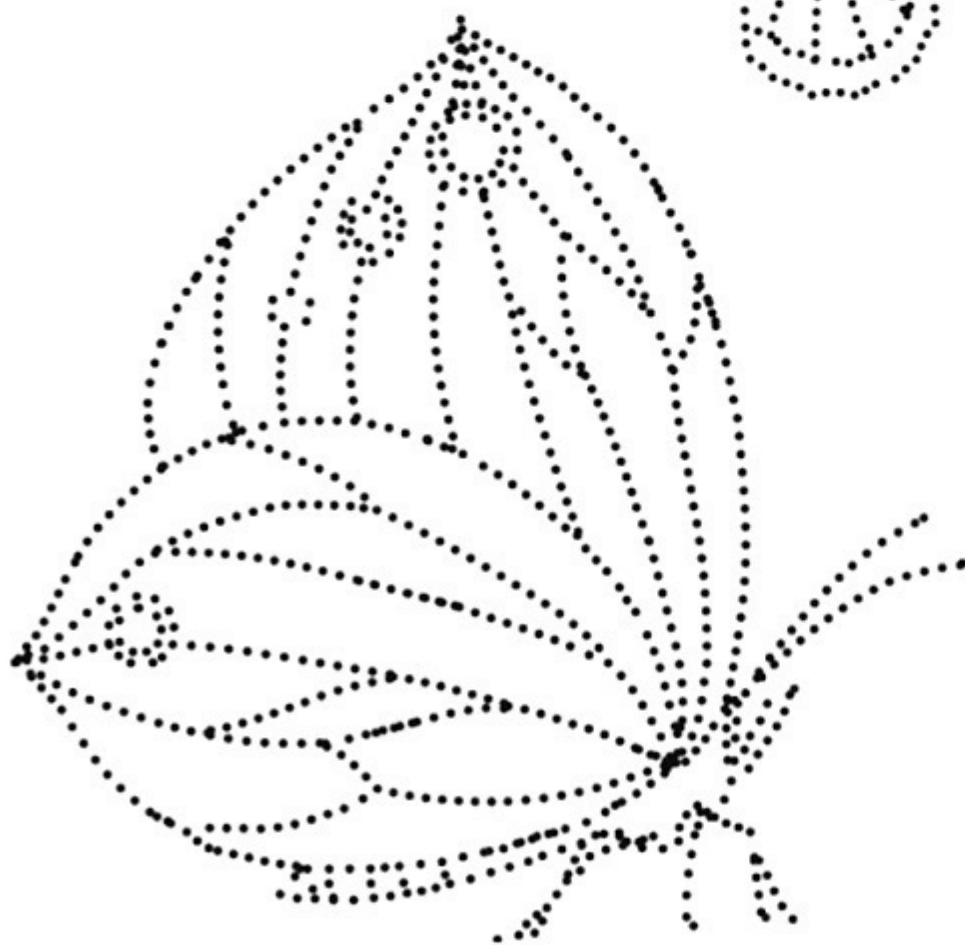
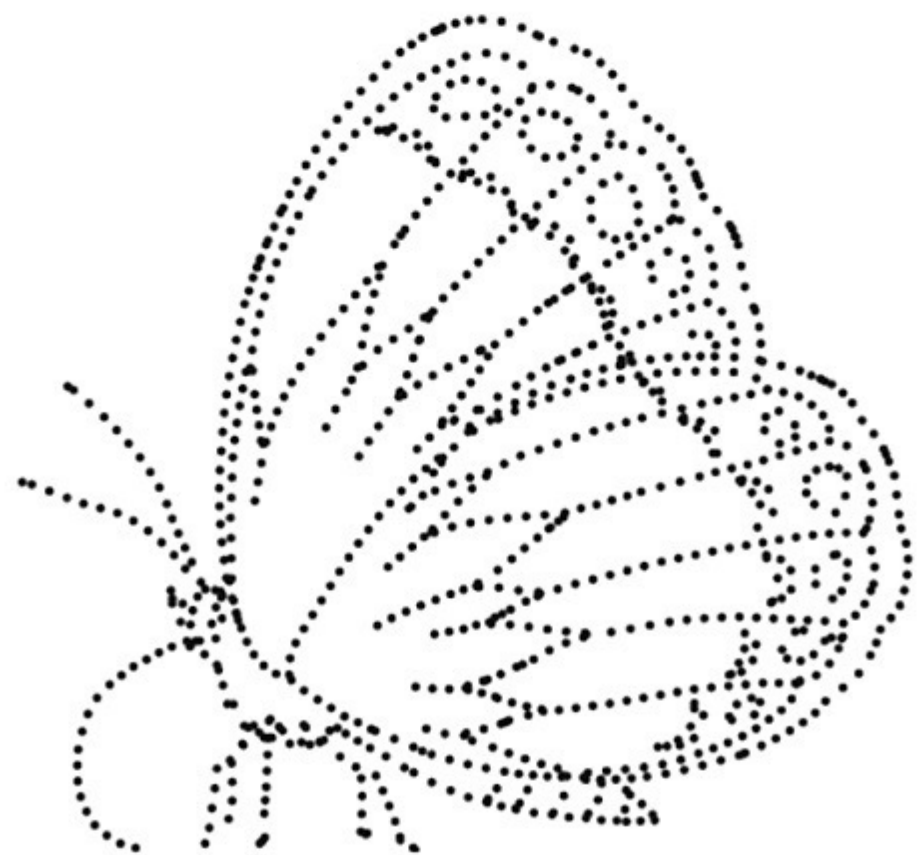
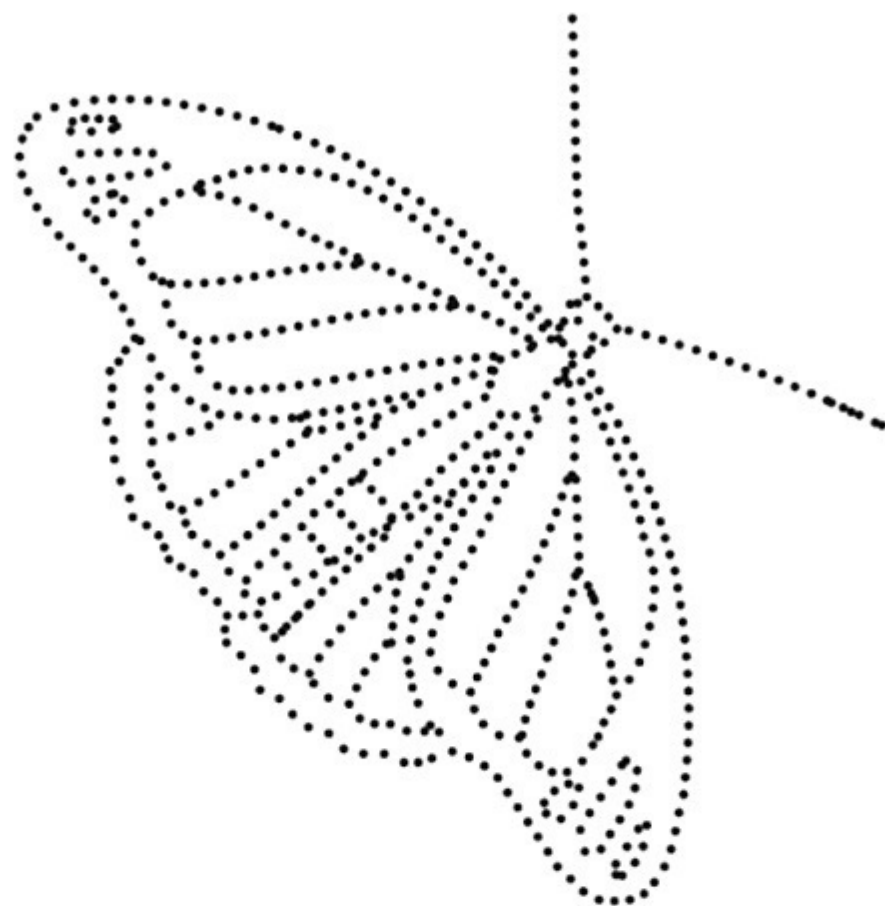

- Доцртај и обој лептира.

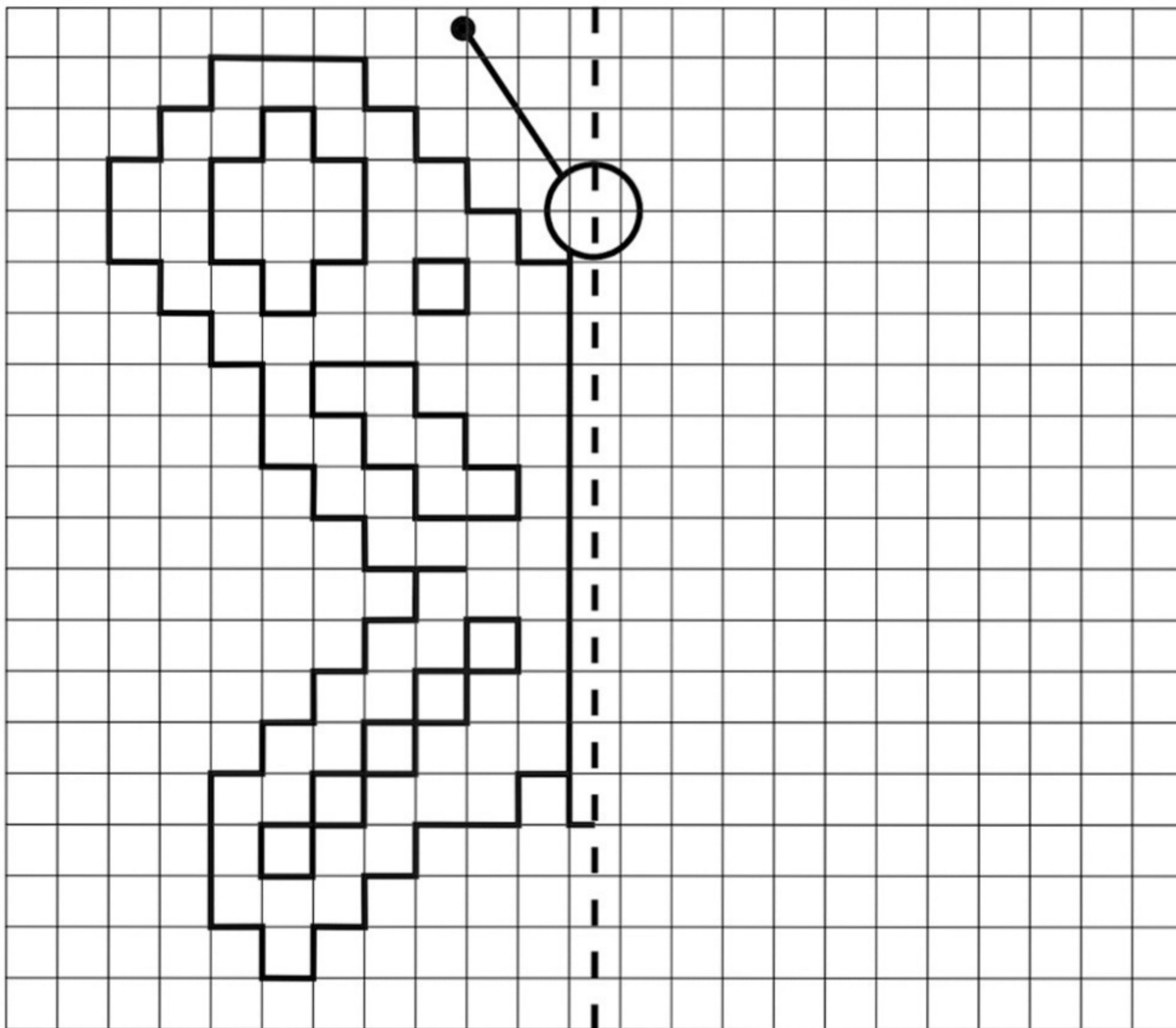

- Настави да црташ као што је започето.

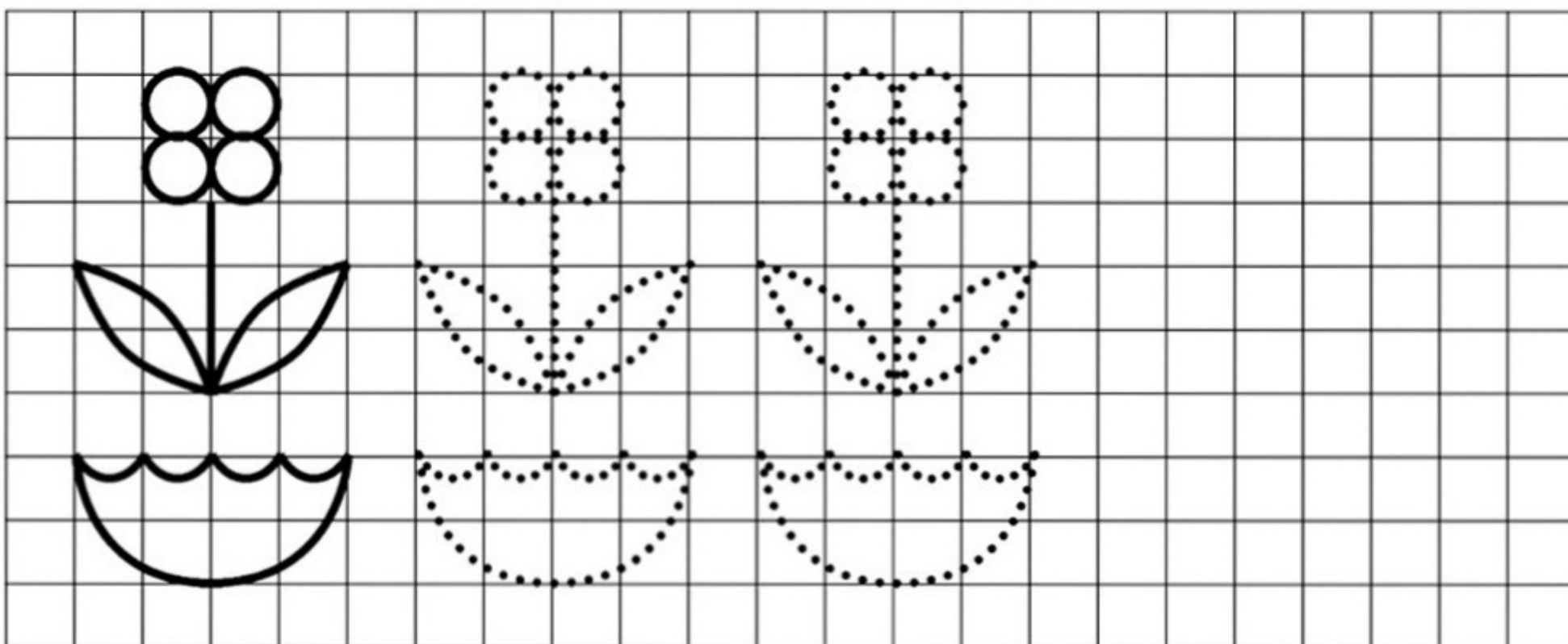

- Подебљај цветиће по тачкицама и обој.

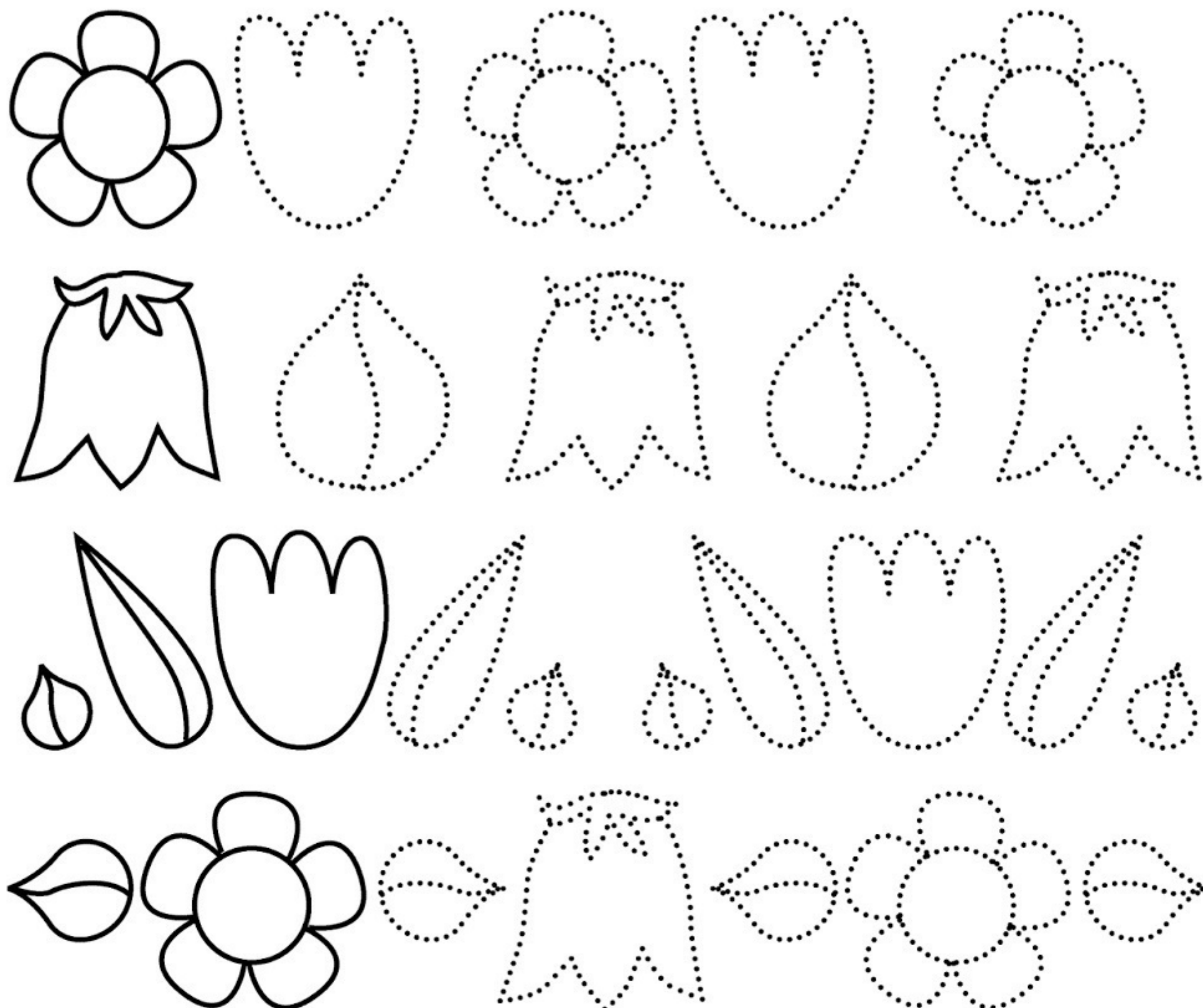

- Подебљај шаре на тепиху. Нацртај исте такве на тепиху десно и обој оба.

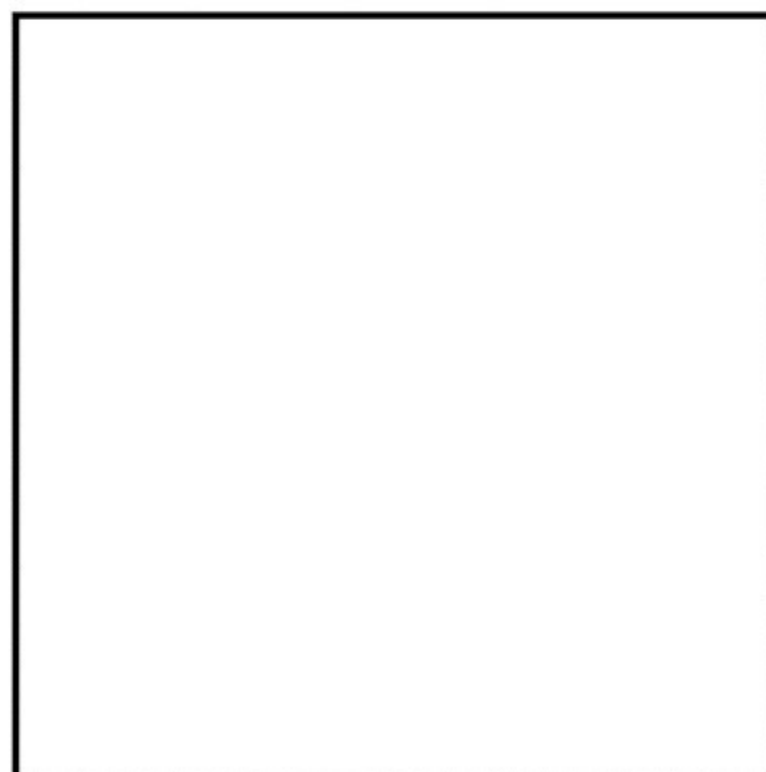
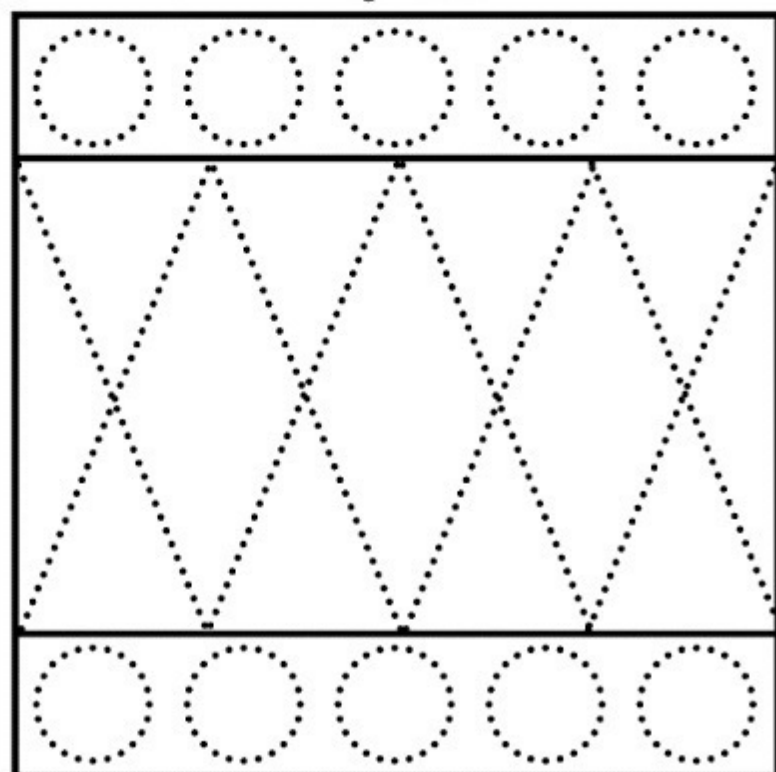

- Доцртај и обој цртеже.

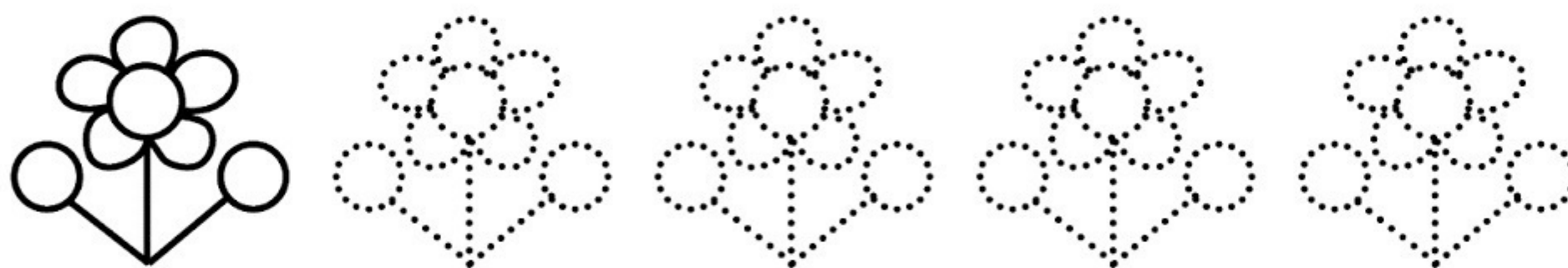
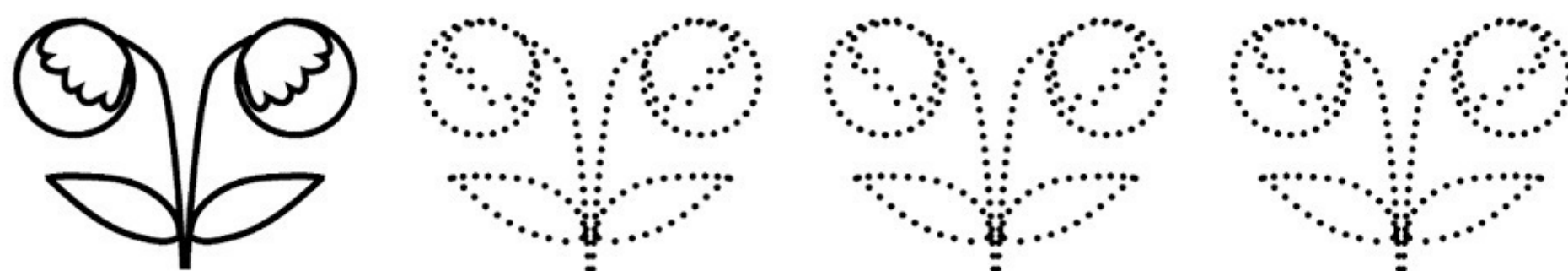

- Подебљај шаре на тепиху. Нацртај исте такве на тепиху десно и обој оба.

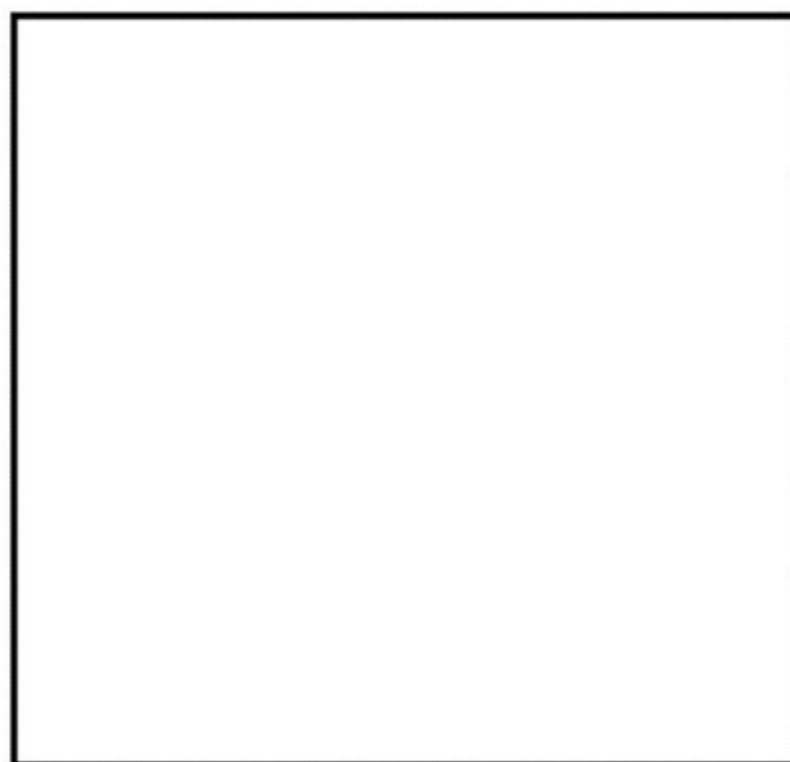
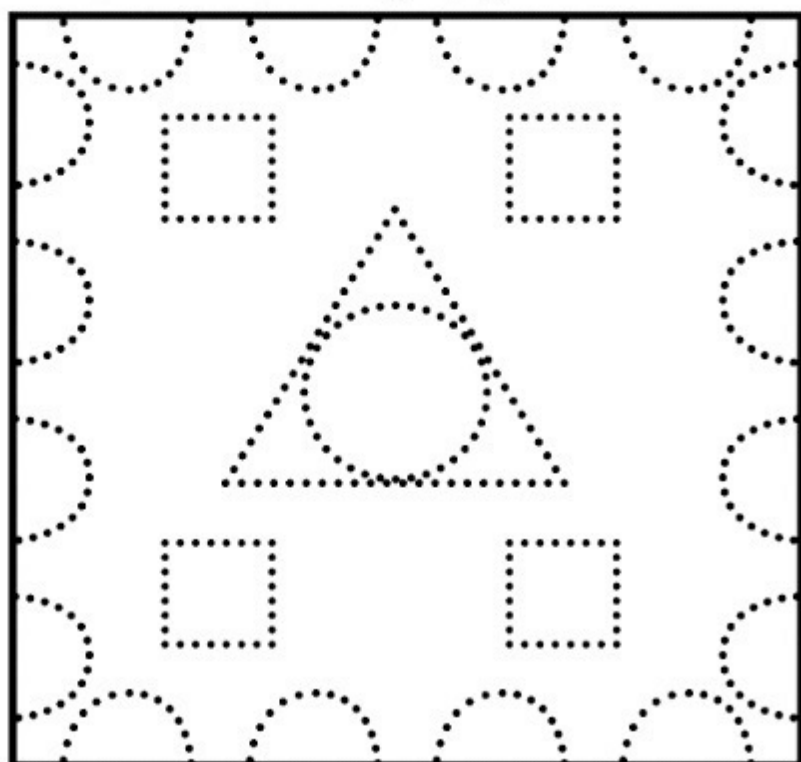

- Уз помоћ лењира нацртај исти цртеж. Обој.

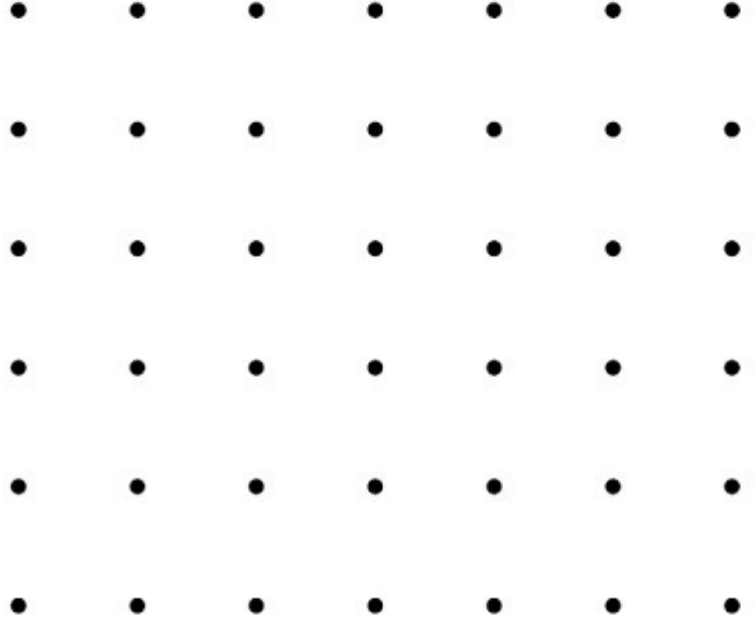
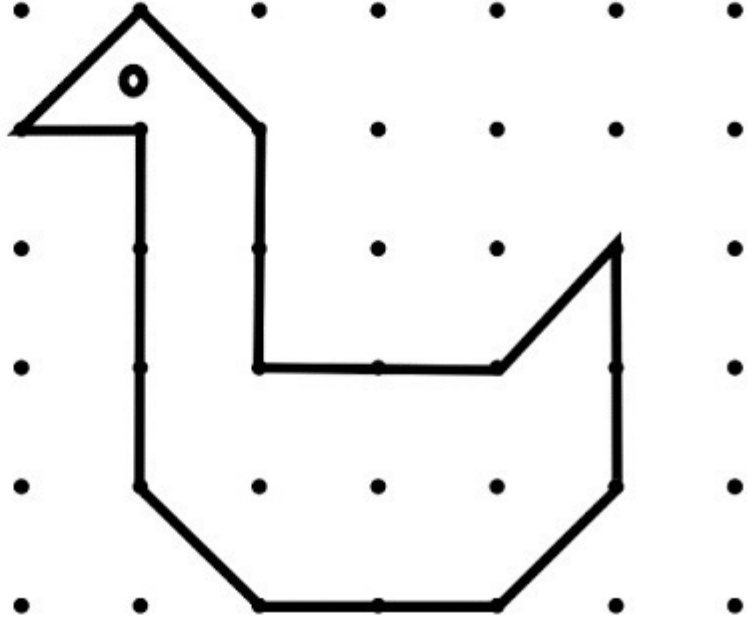
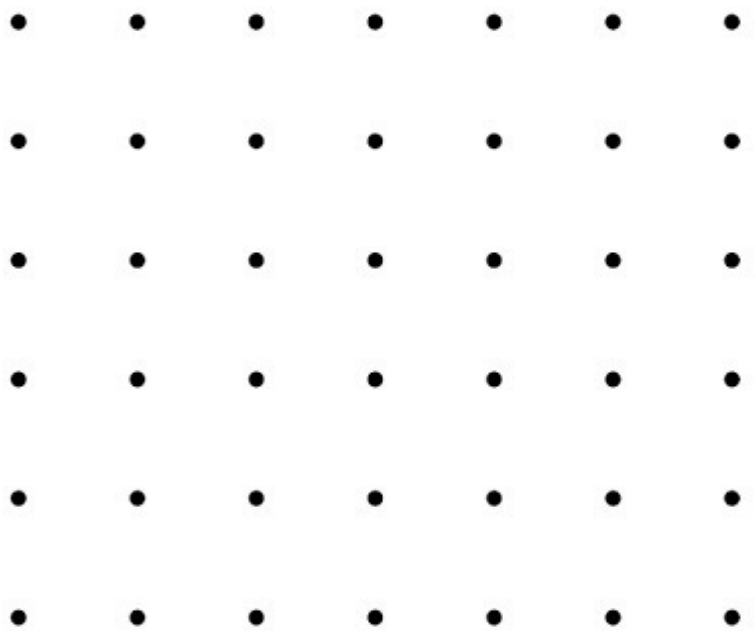
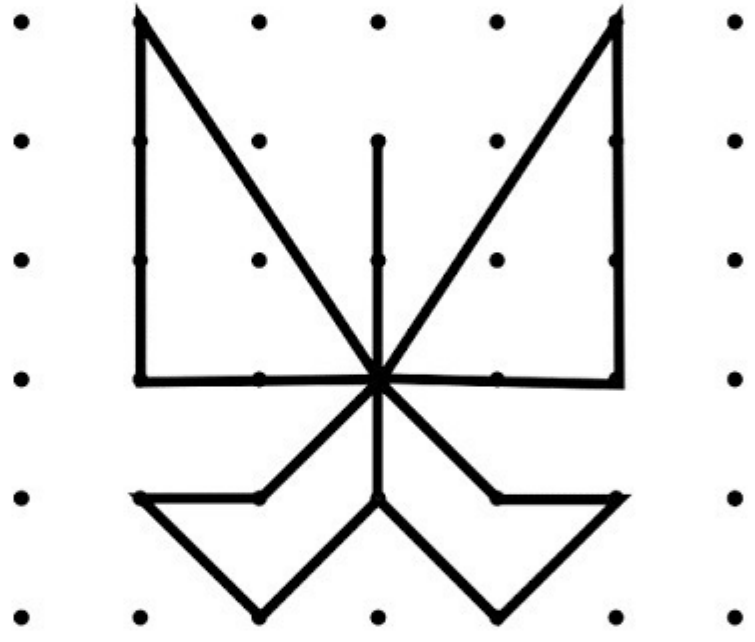
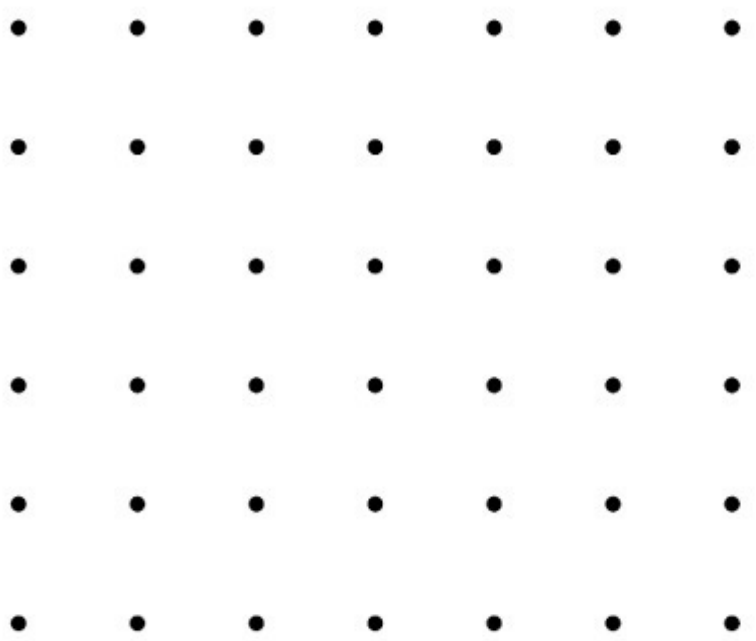
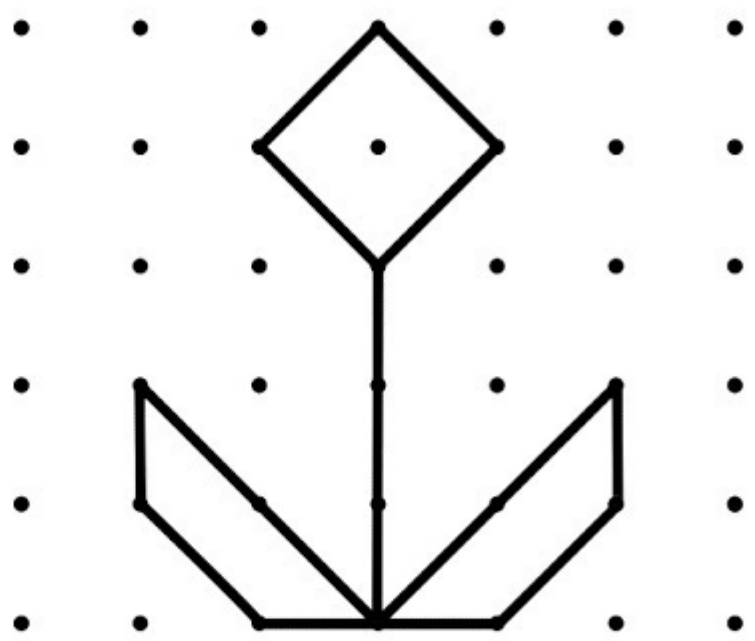

- Повежи тачке по реду и обој цвеће.

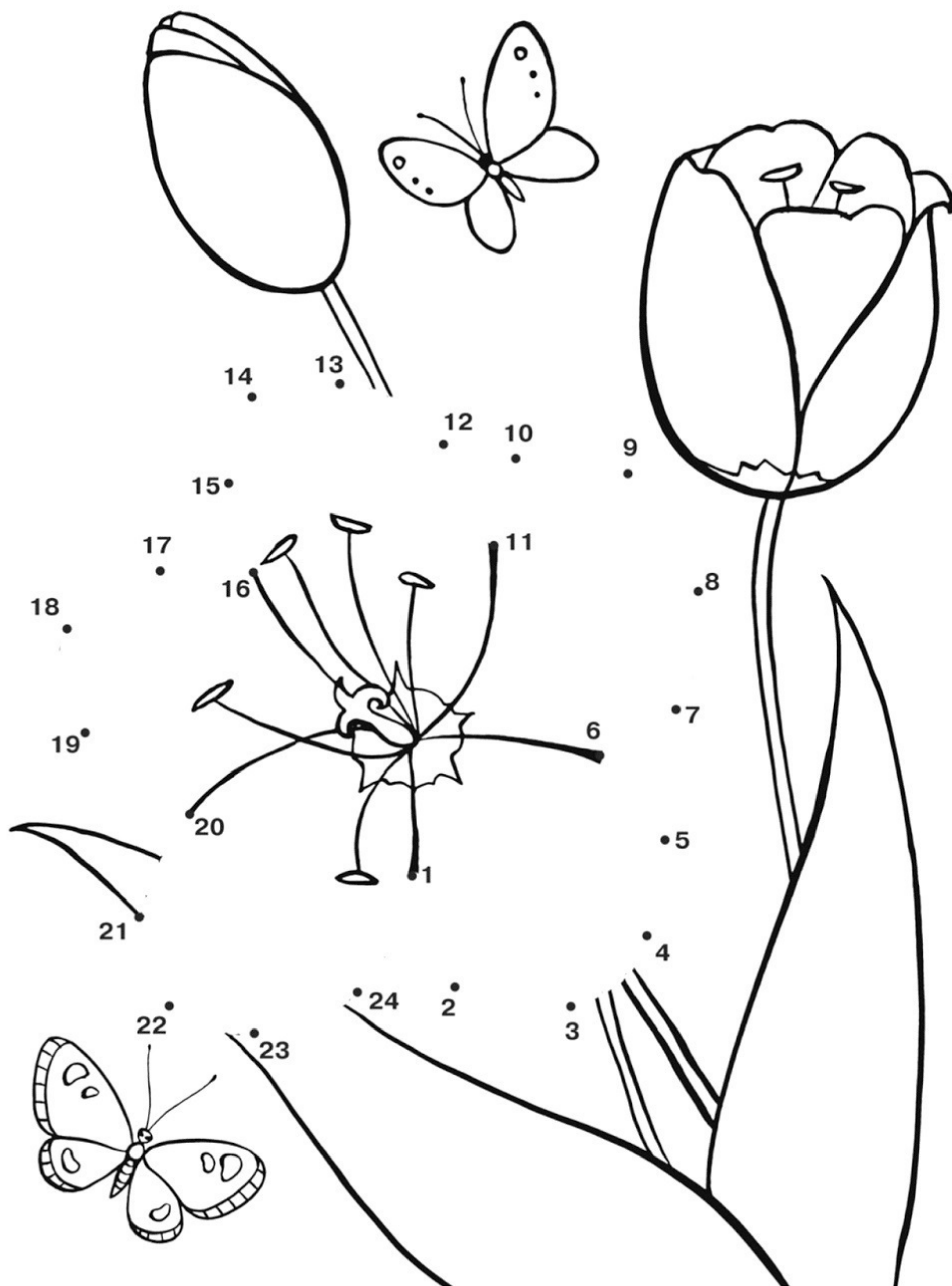

- Подебљај слова по тачкама.

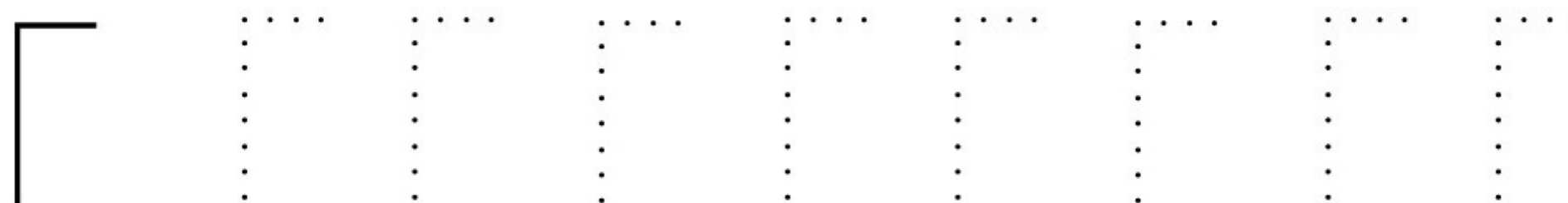
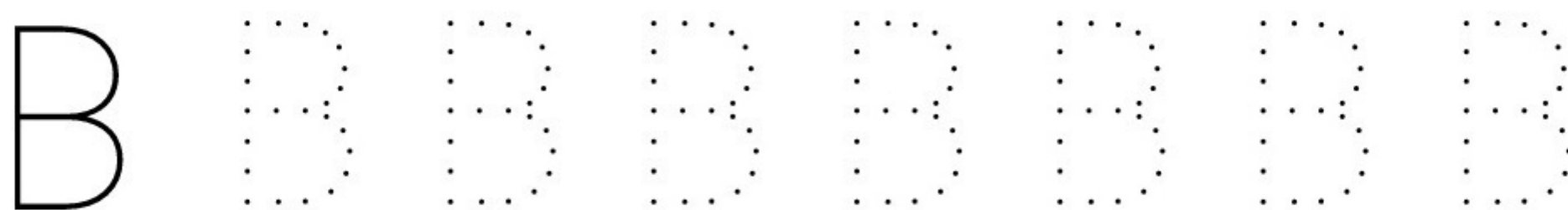
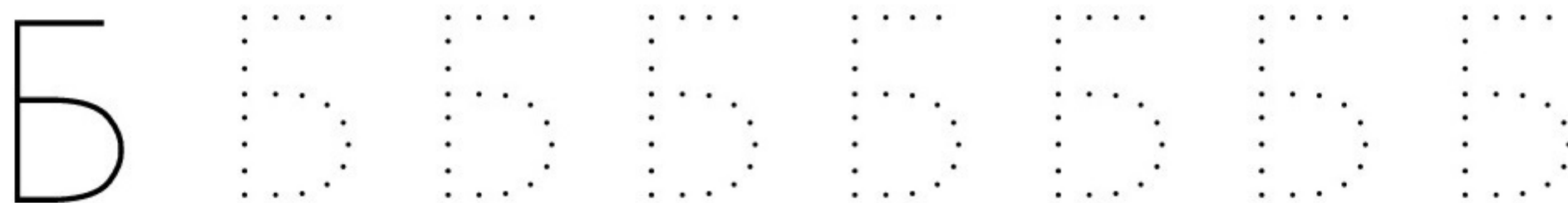

- Доцртај и обој ограду.



- Подебљај, па обој истом бојом животиње чије име почиње истим почетним словом.

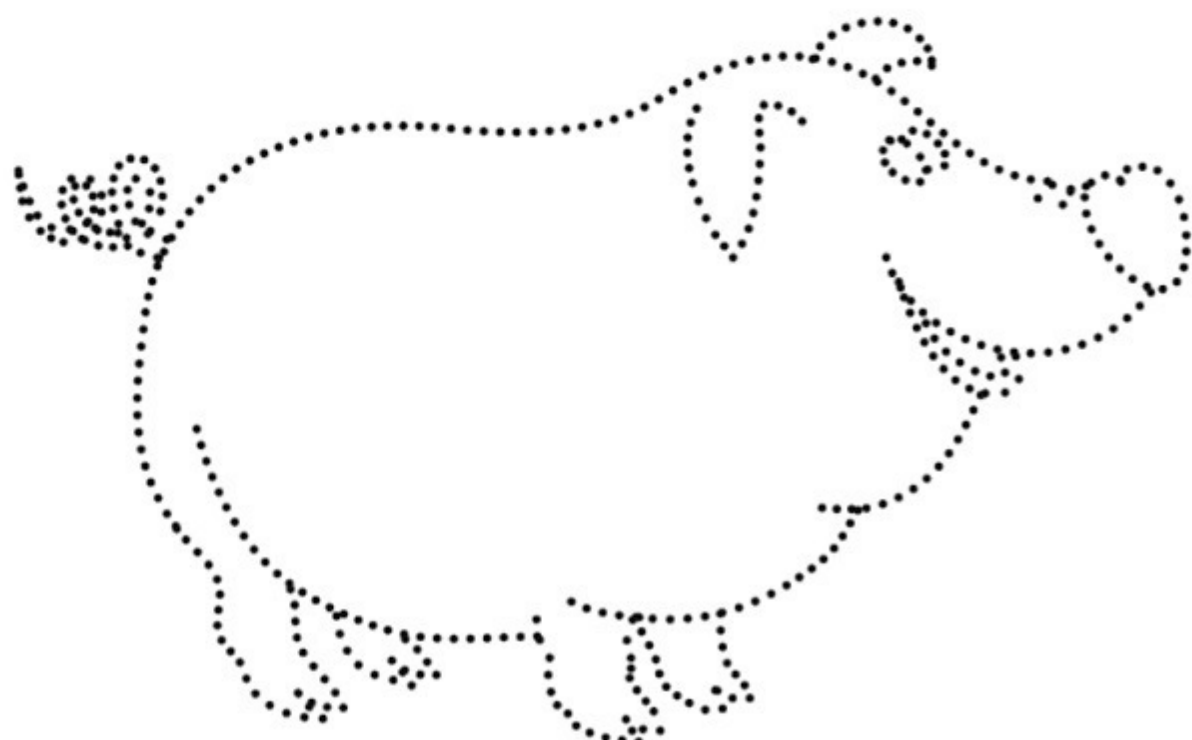
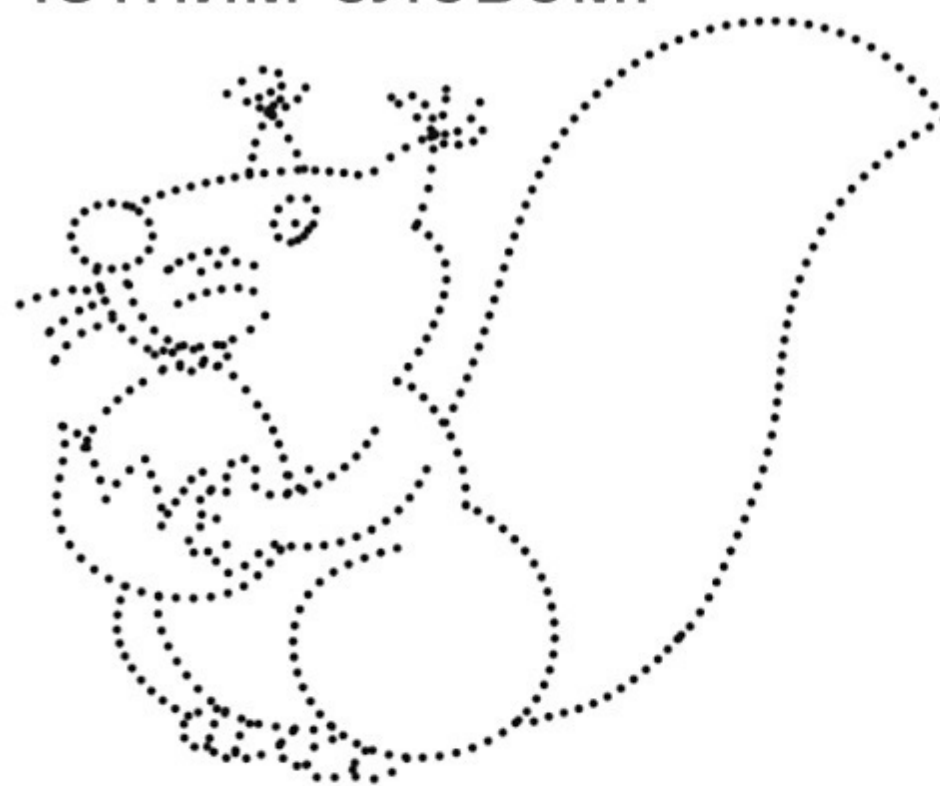

- Подебљај слова по тачкама.

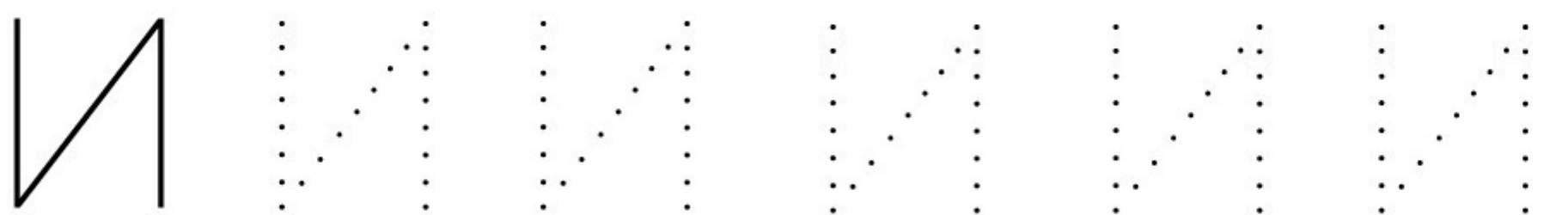
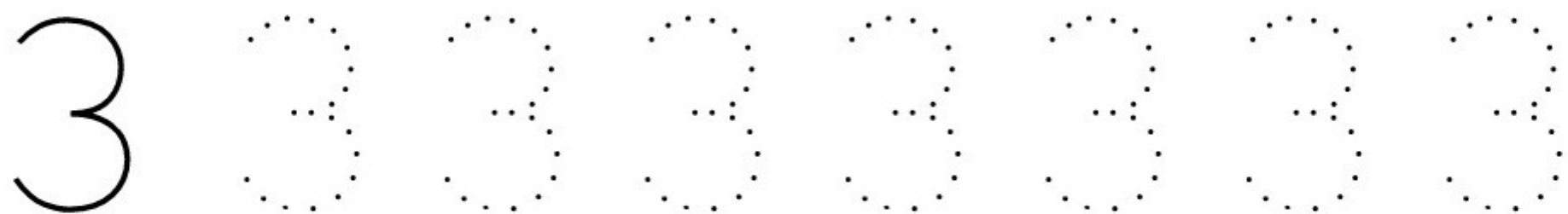
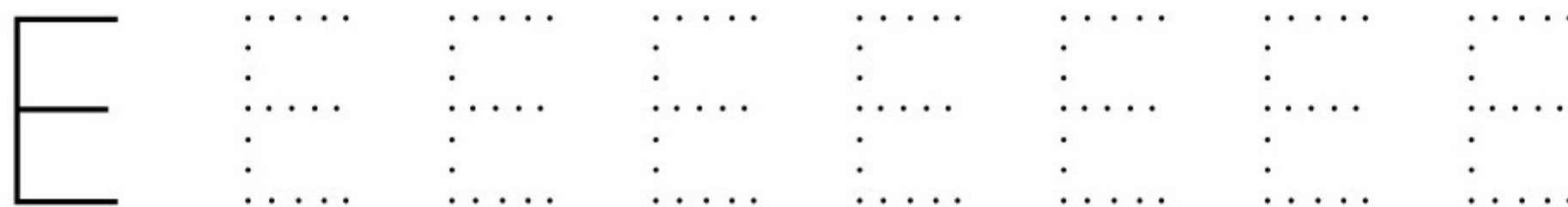

- Настави као што је започето.

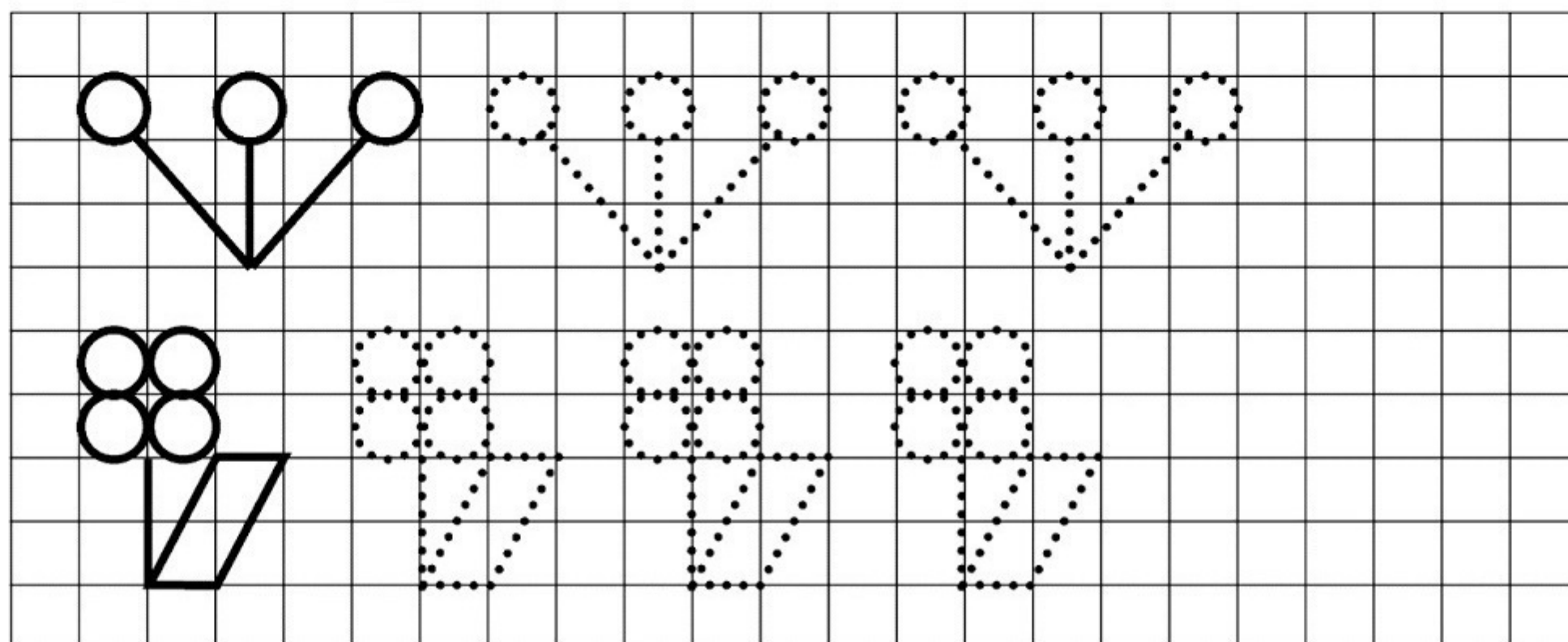

- Уз помоћ лењира нацртај исти цртеж.

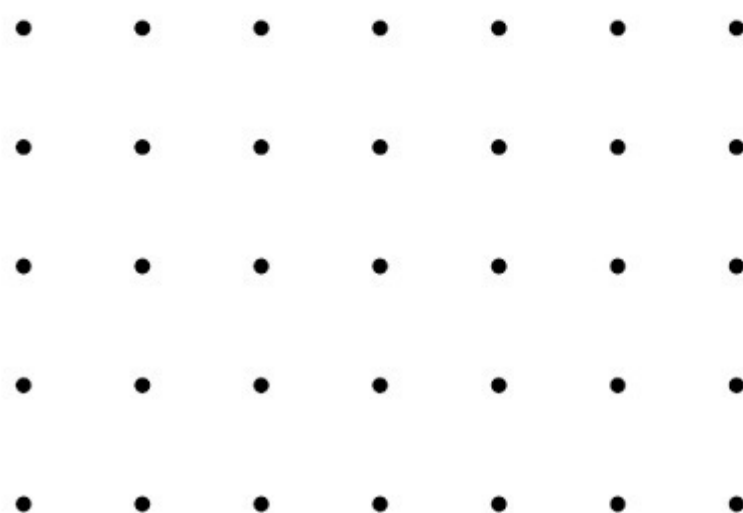
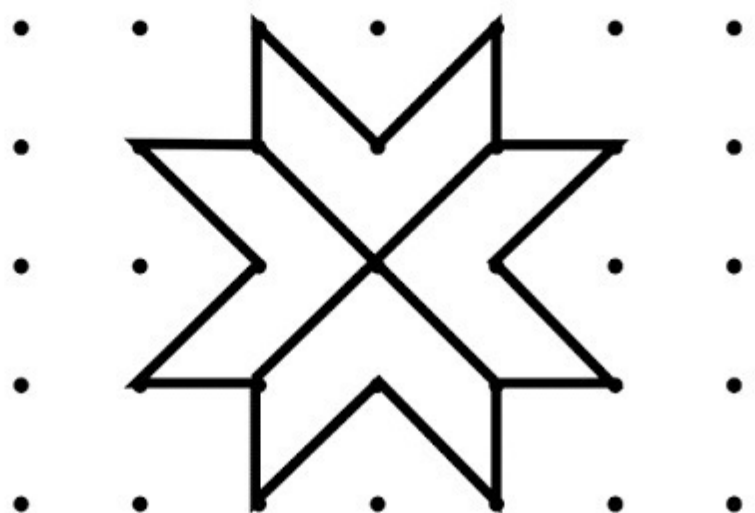
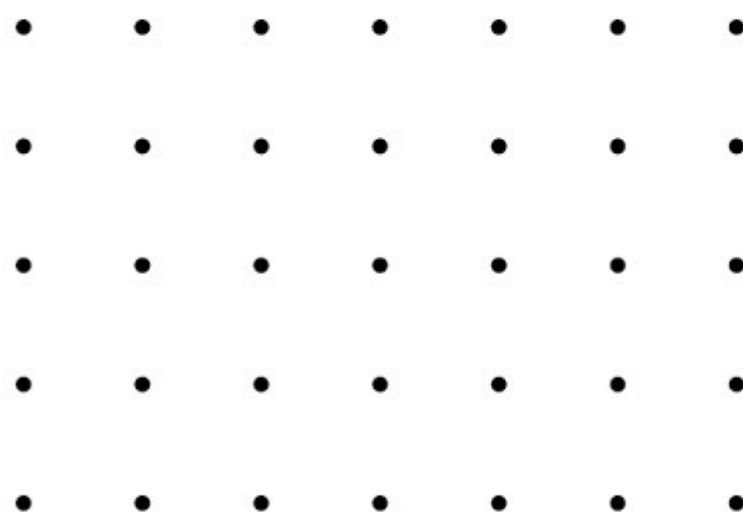
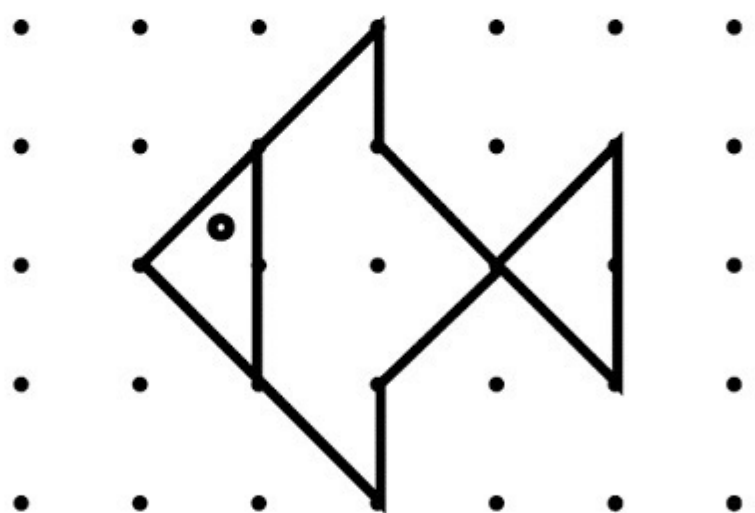
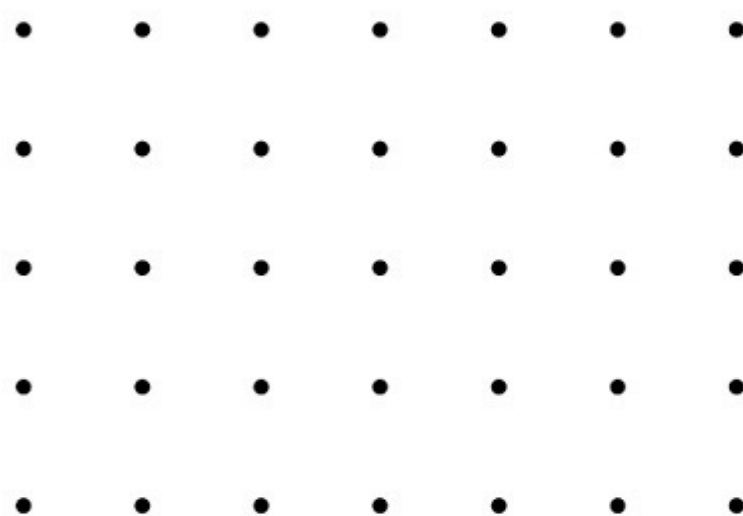
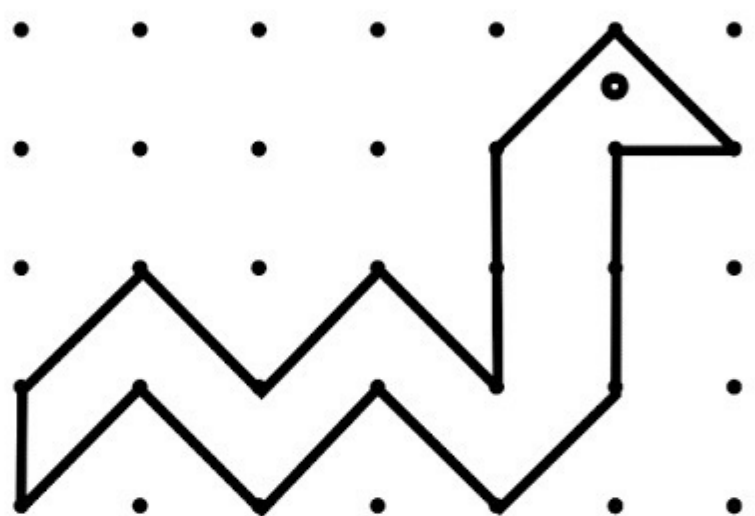
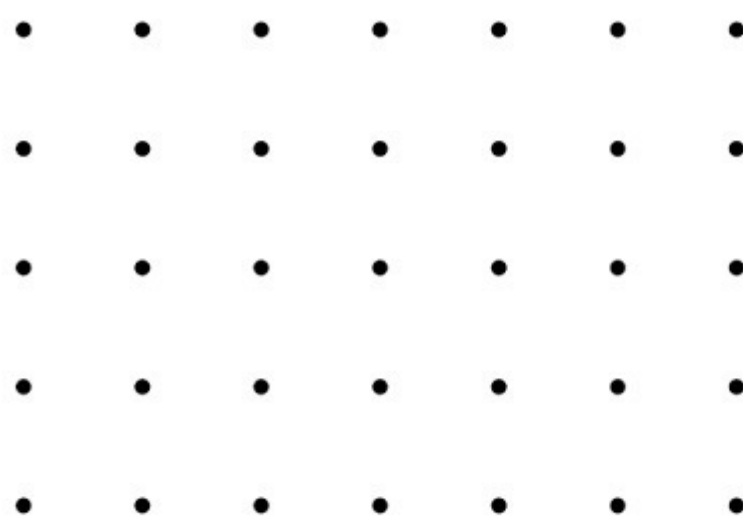
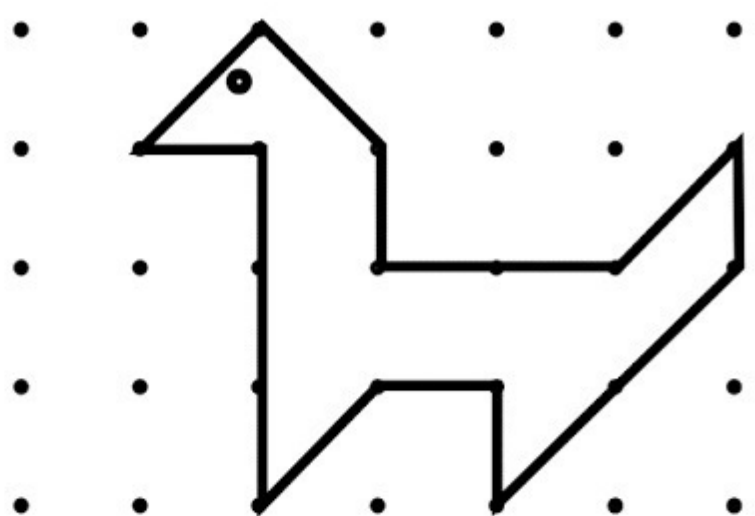

- Подебљај слова по тачкама.

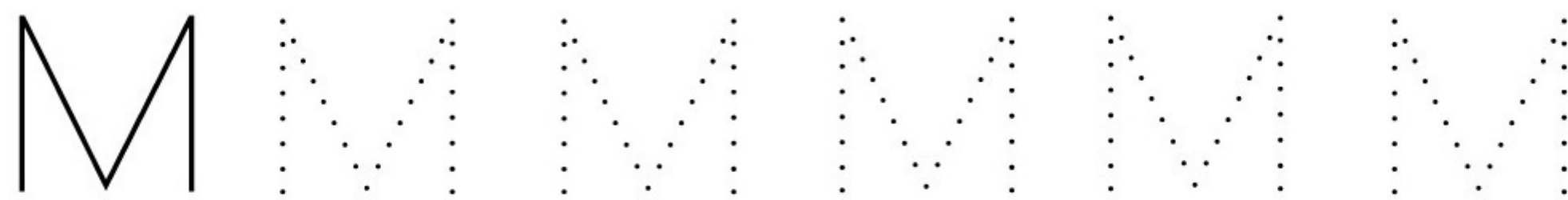
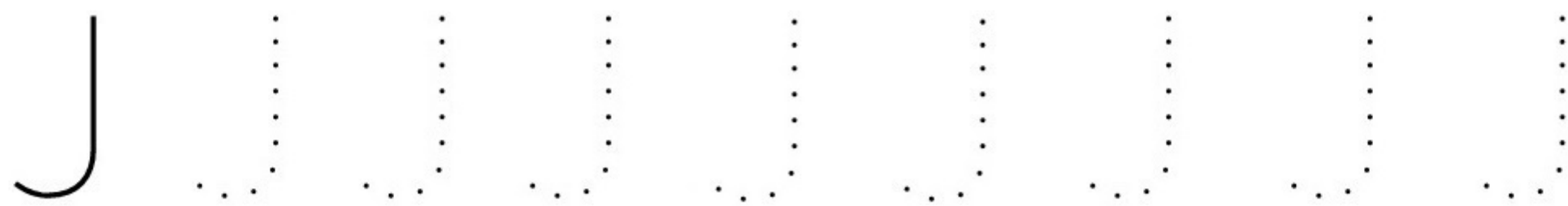

- Доцртај бубице.

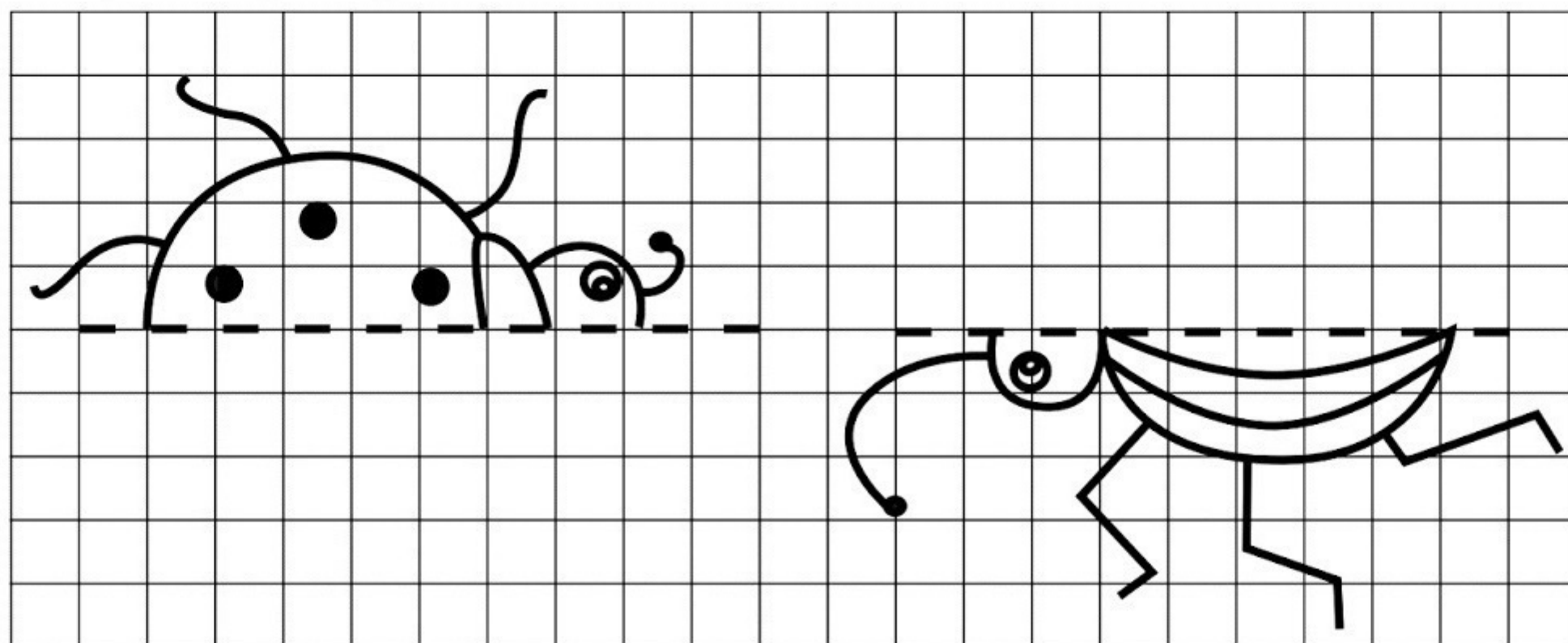

- Доцртај по квадратићима мишића и обој га.

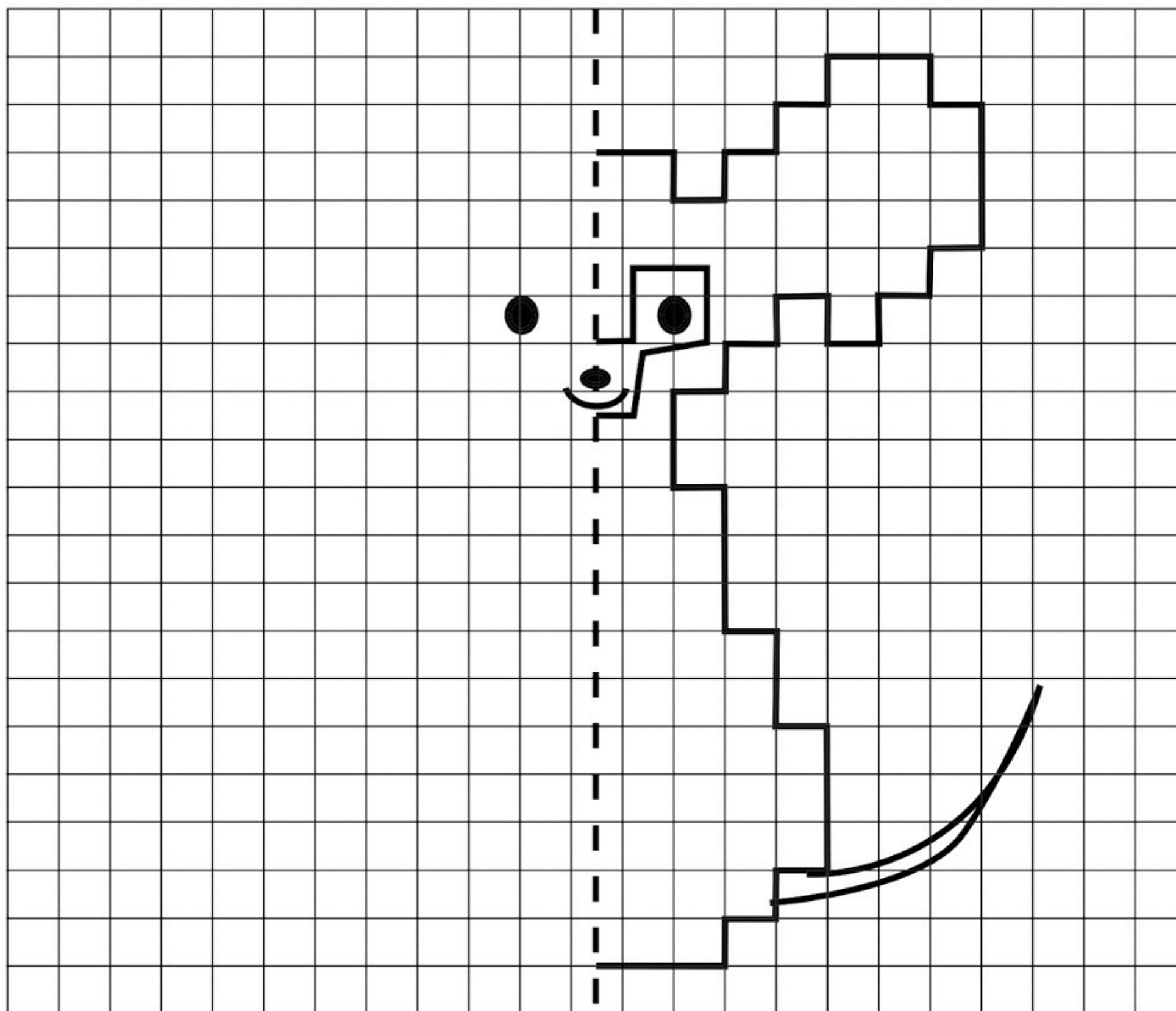

- Настави као што је започето.

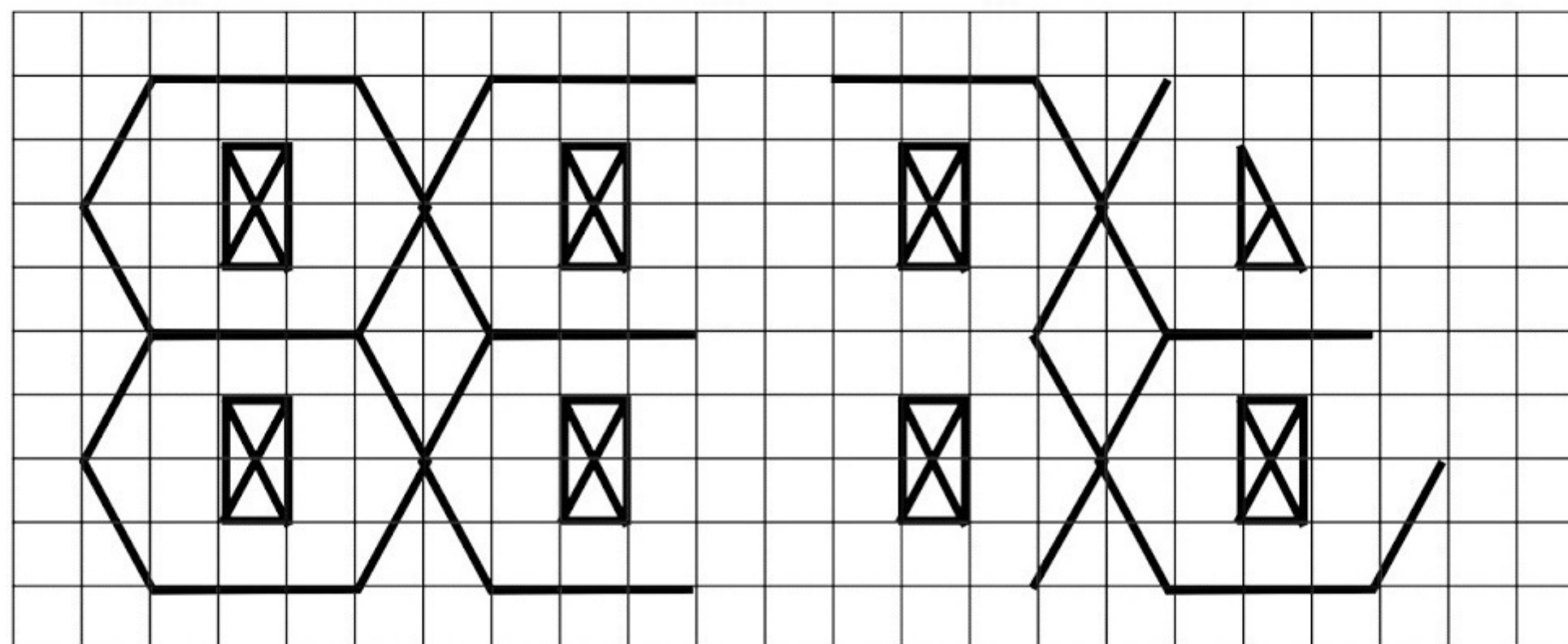

- Подебљај слова по тачкама.

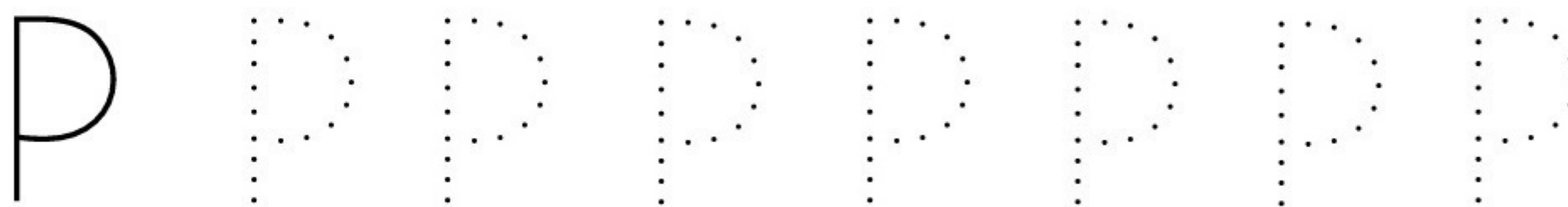
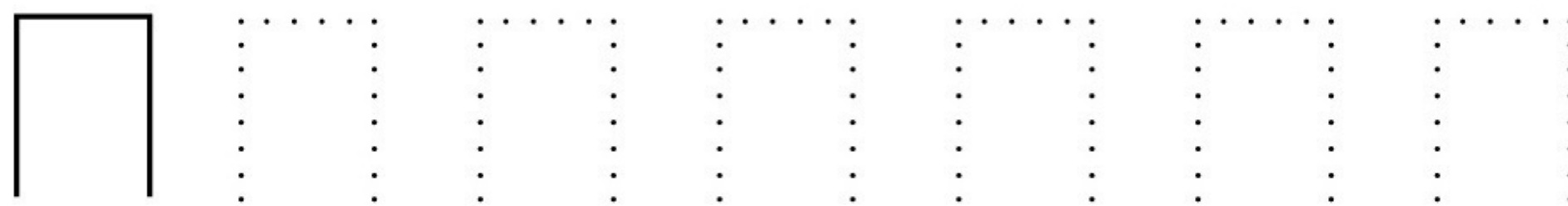
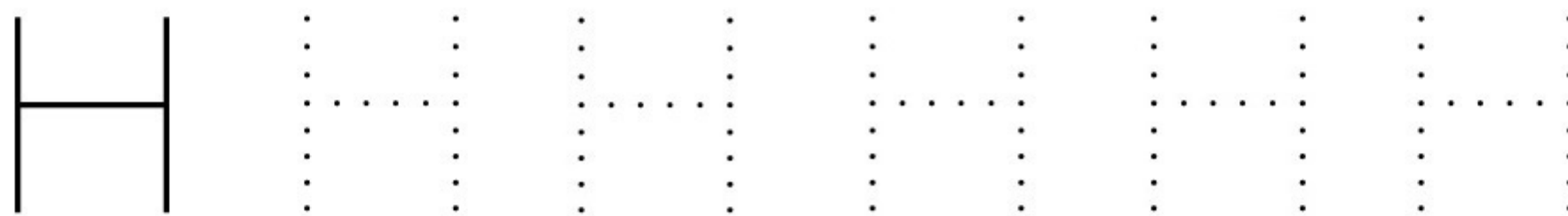

- Обој квадрате тако да добијеш слова Н и Т.

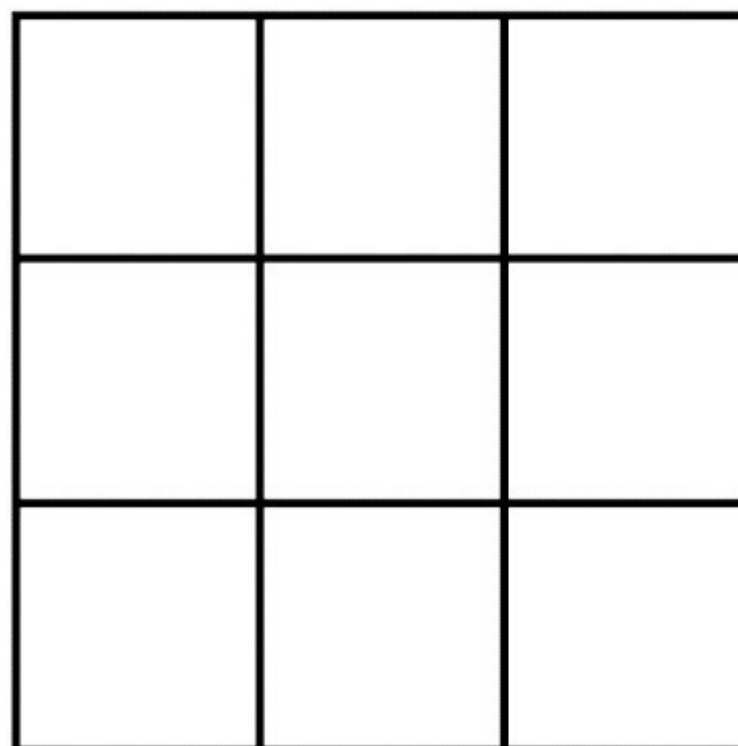
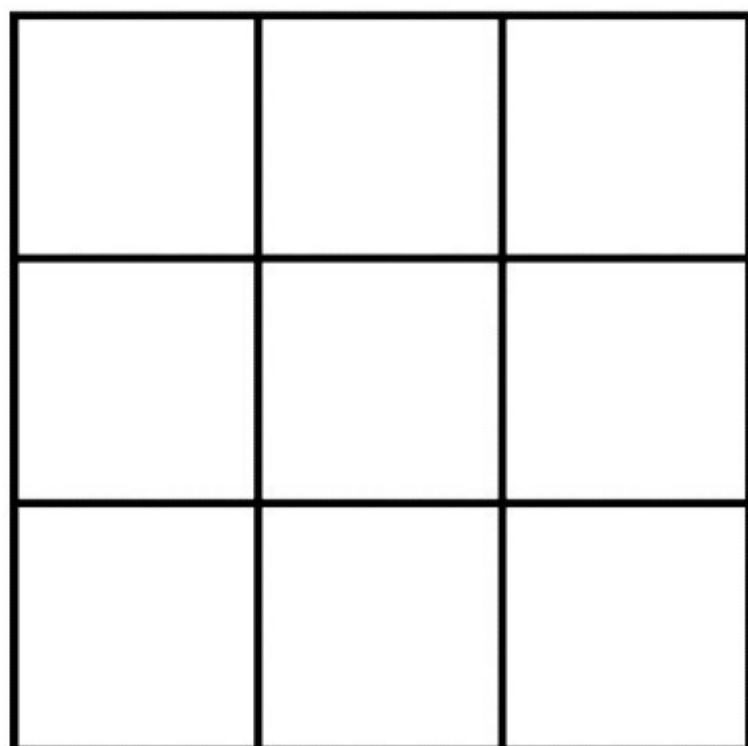

- Подебљај и обој принцезу.

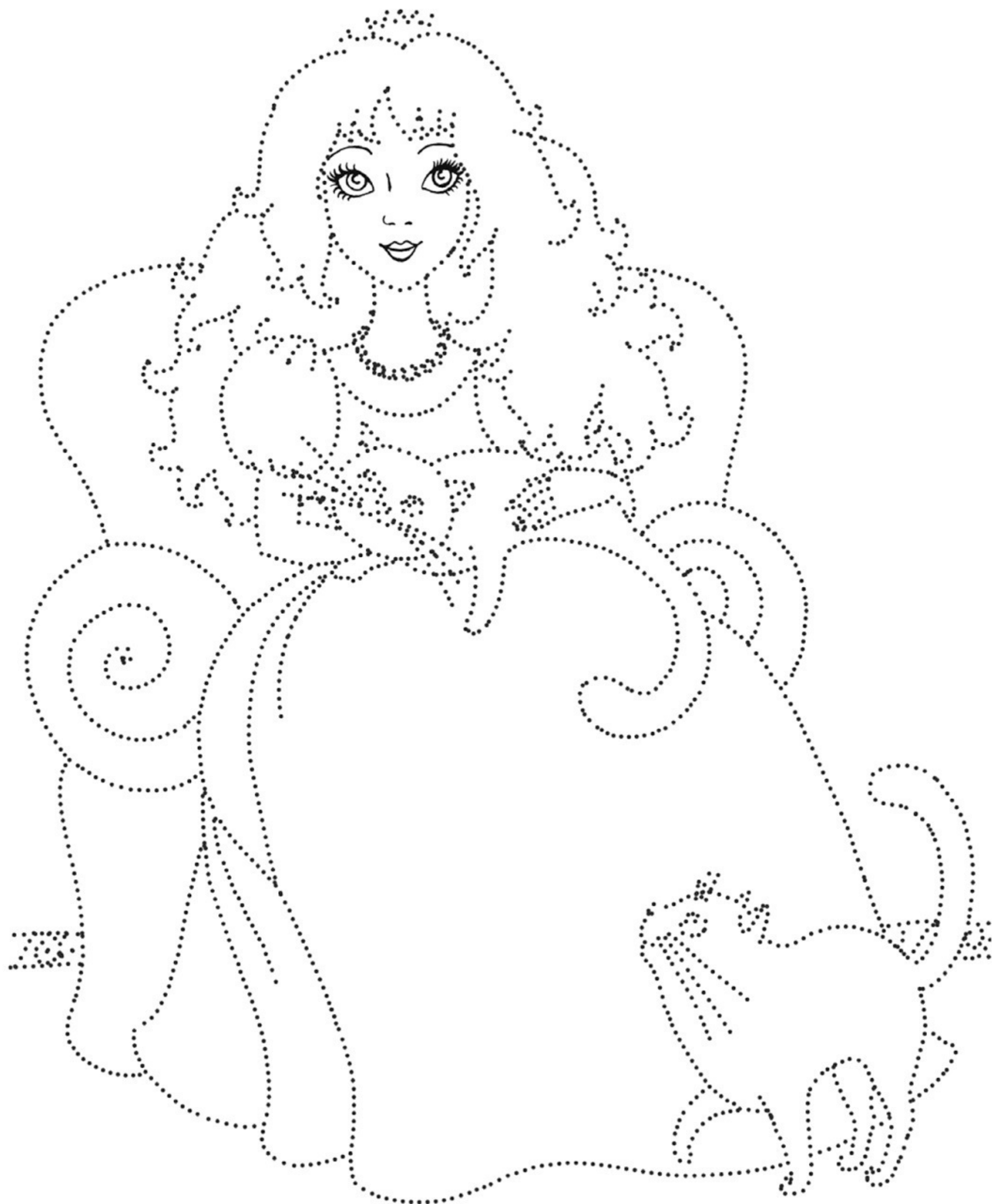

- Подебљај слова по тачкама.

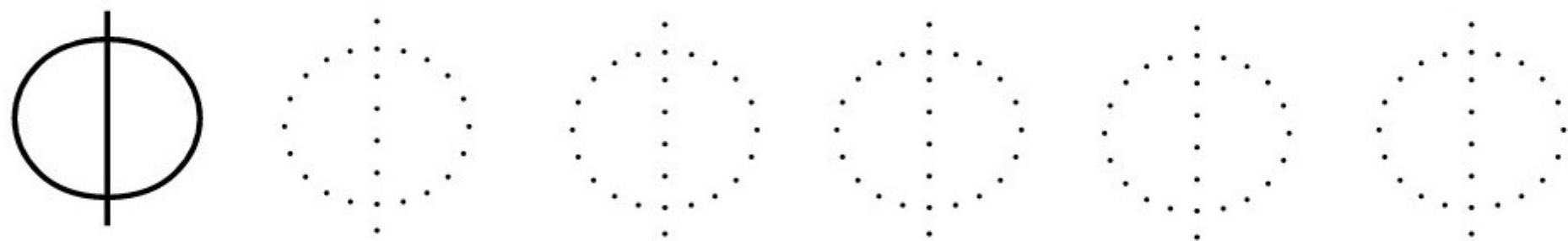
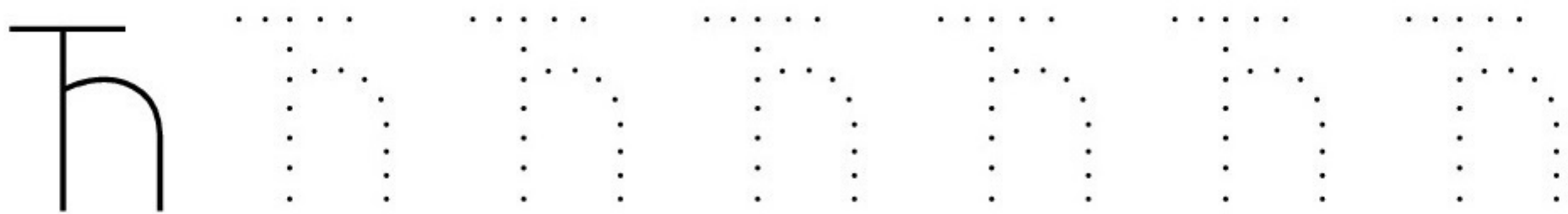
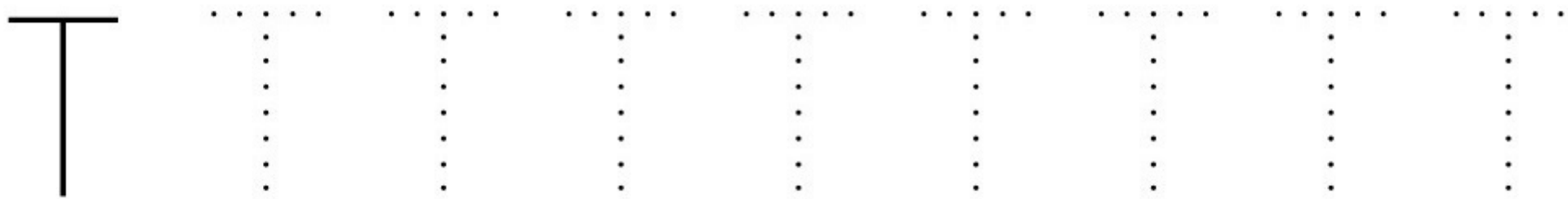

- Настави као што је започето.

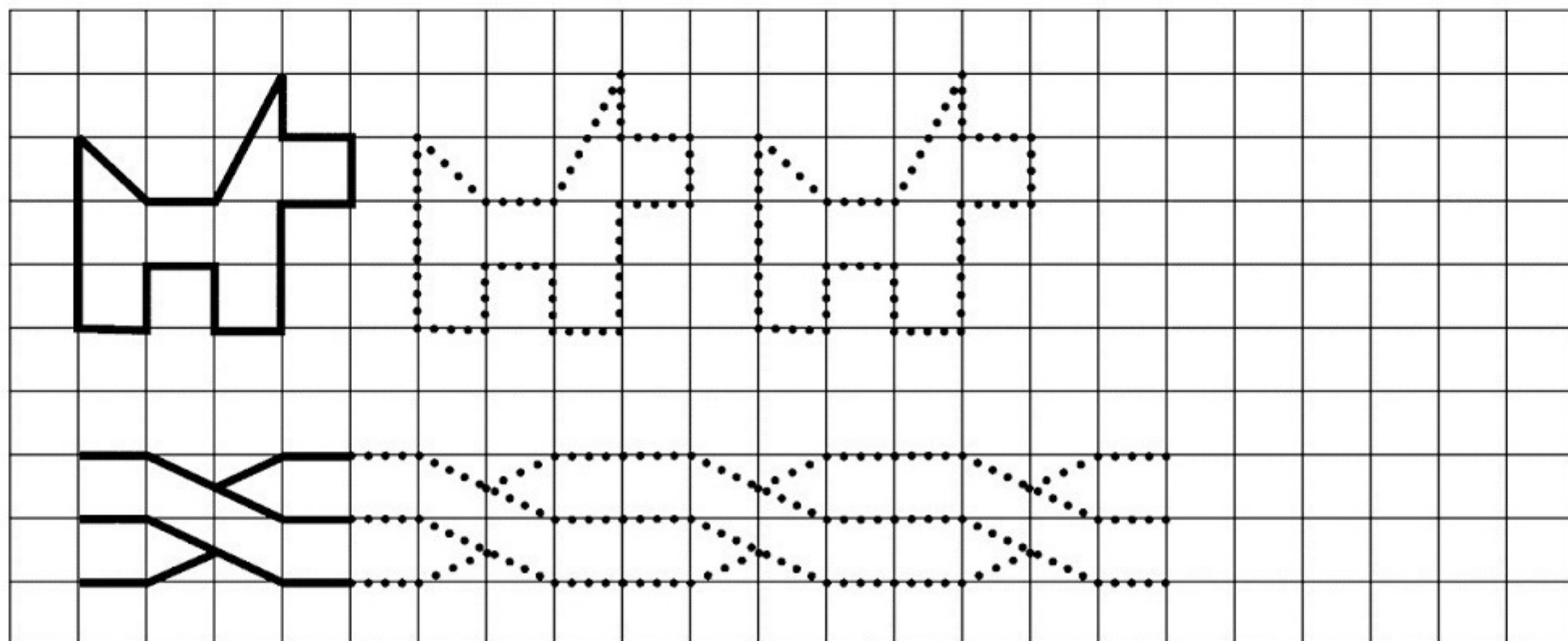

- Прецртај слику као у огледалу и обој мачка.

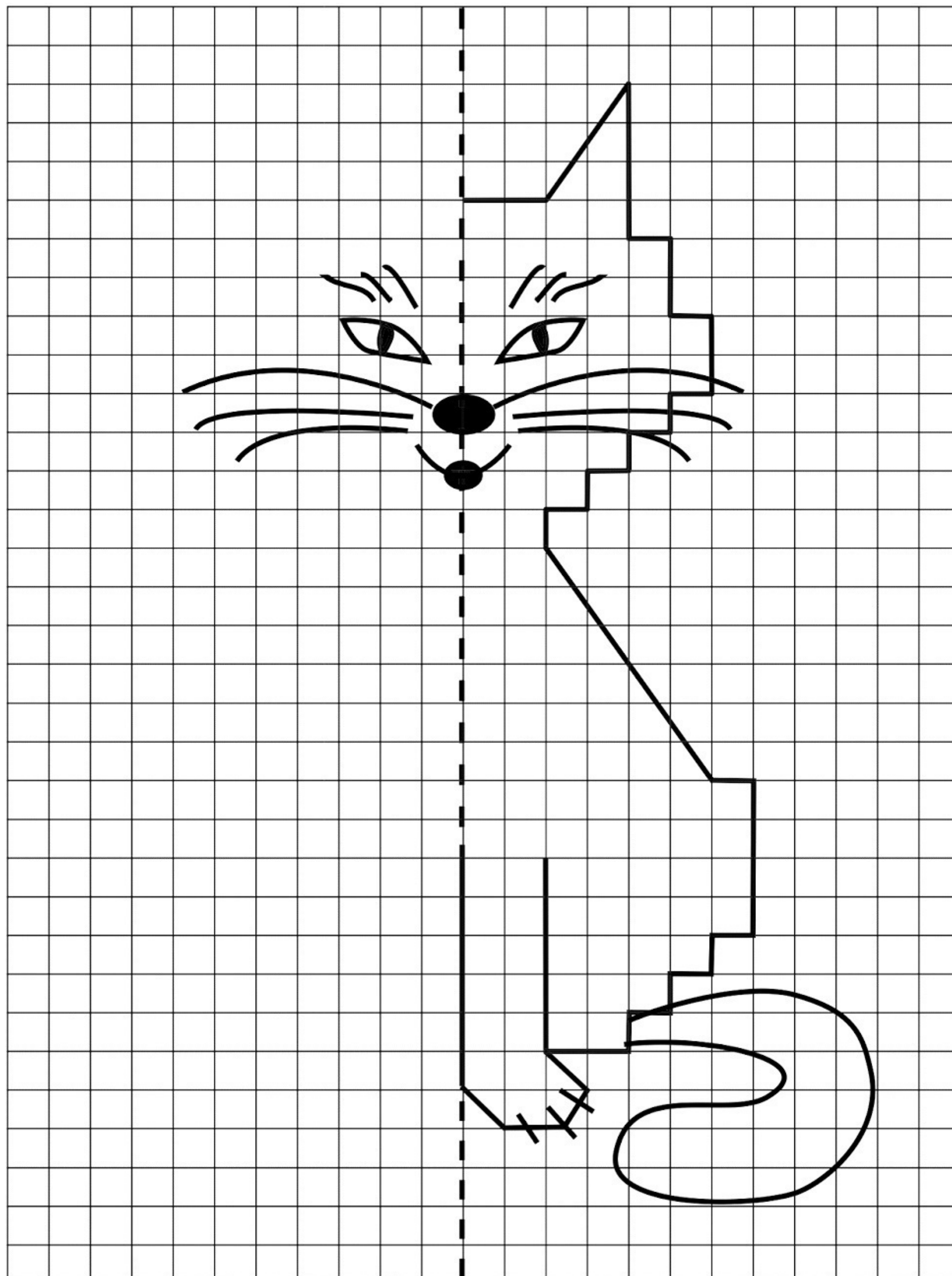

- Подебљај слова по тачкама.

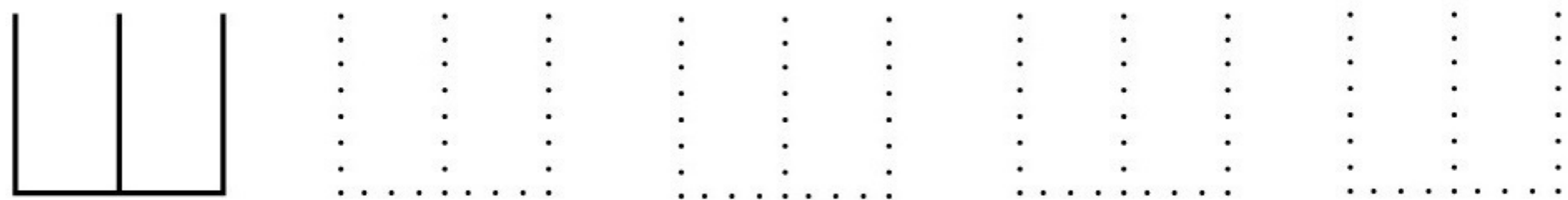
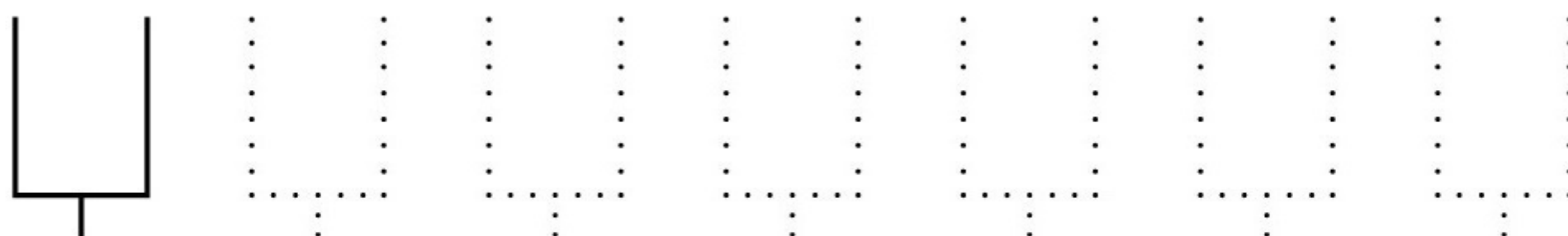
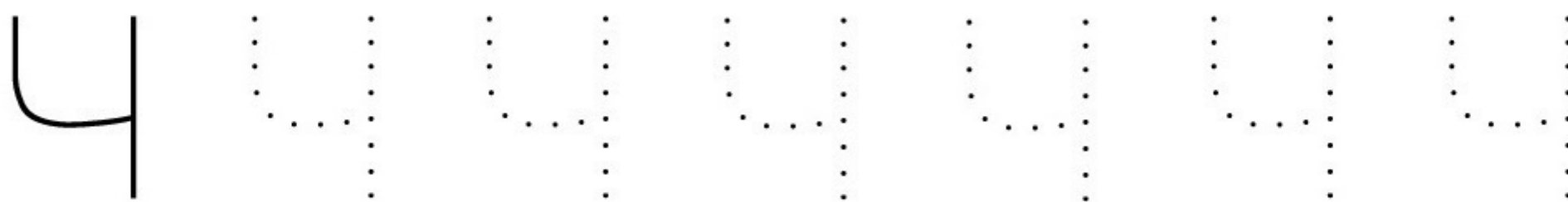
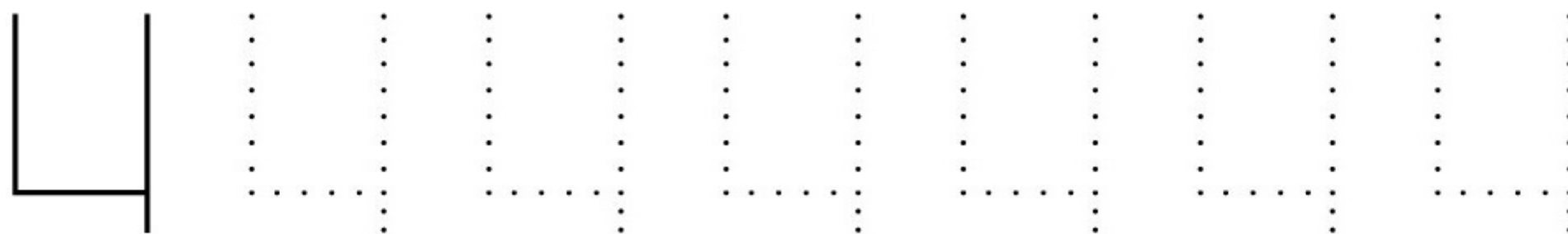

- Подебљај шаре на тепиху. Нацртај исте такве на тепиху десно и обој оба.

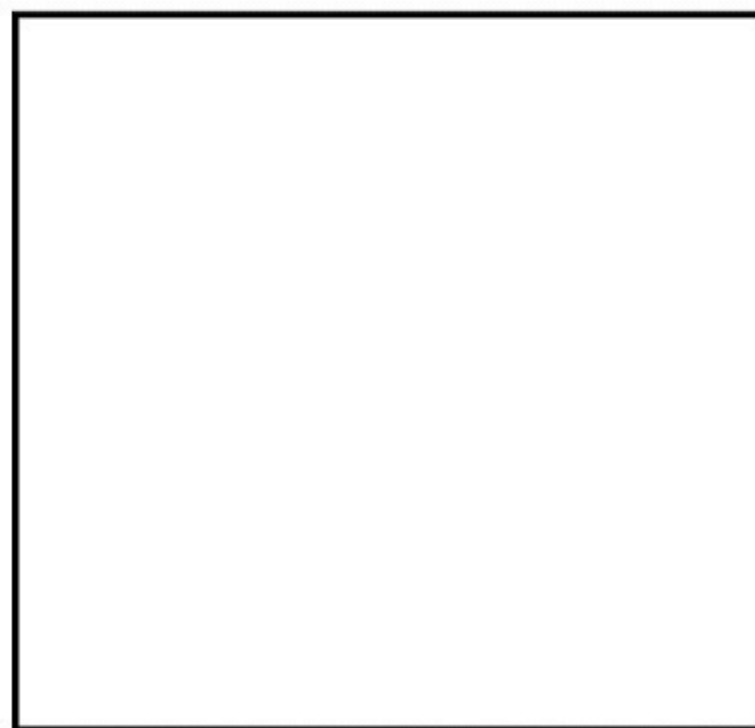
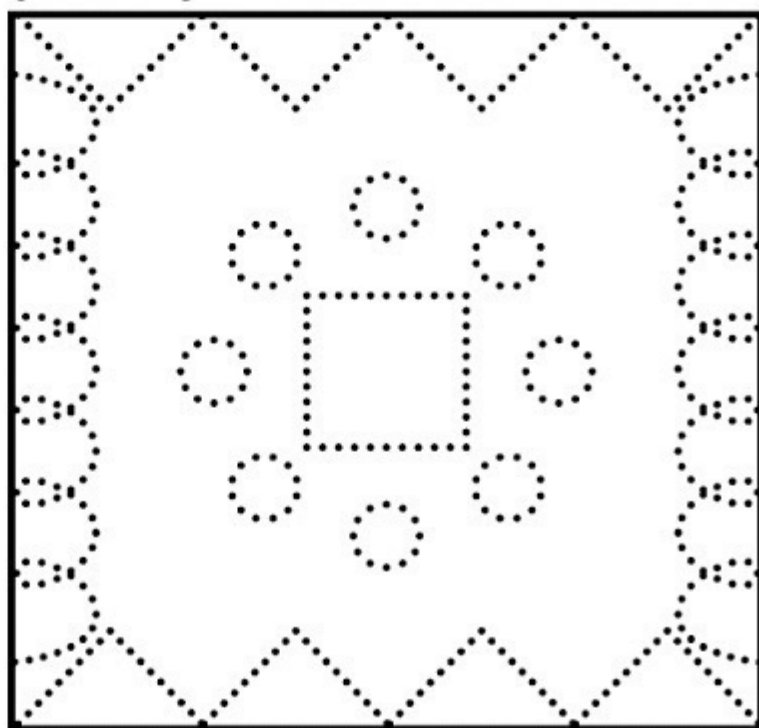

- Подебљај по тачкама и обој.

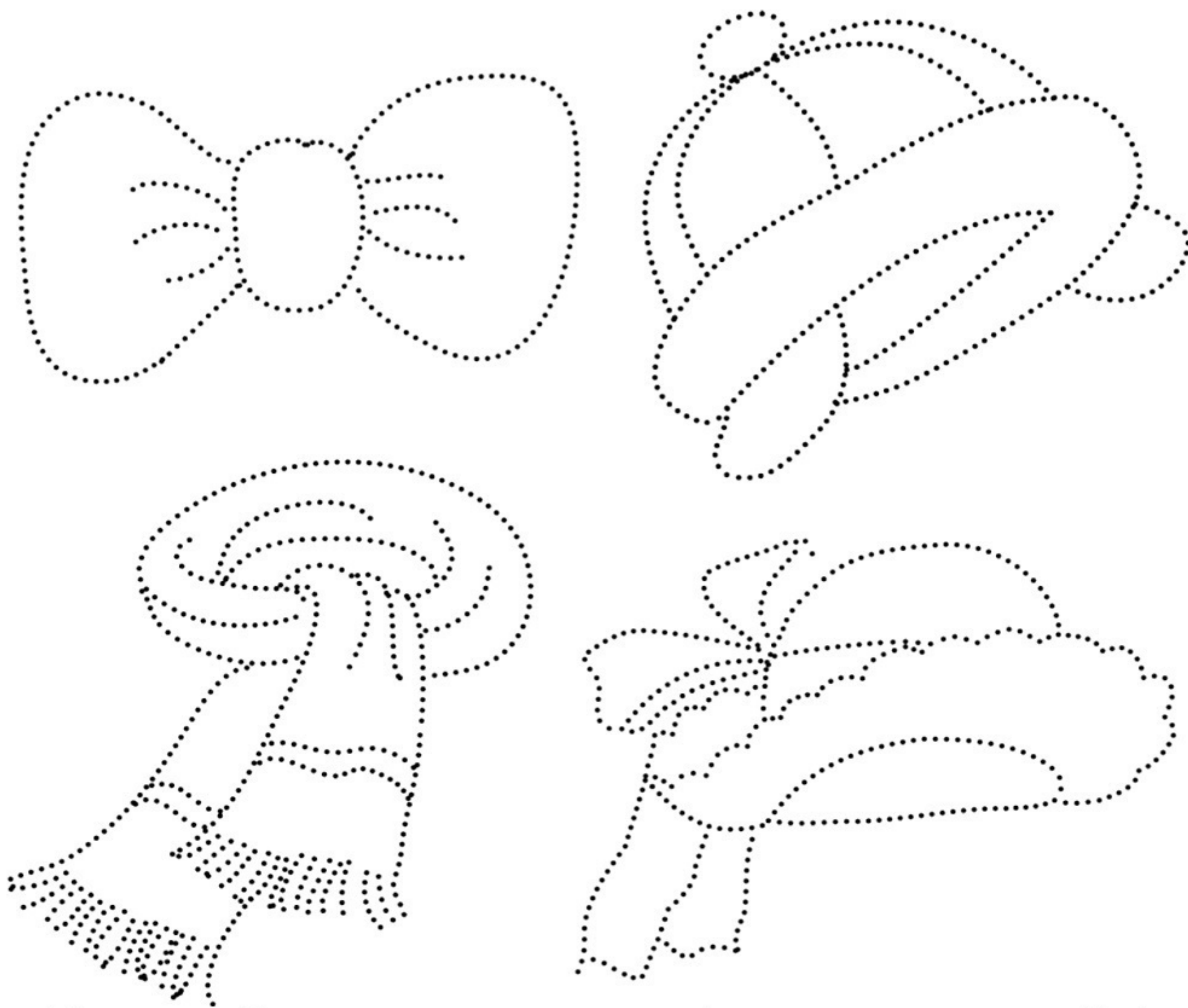

- Уз помоћ лењира прецртај слона, па га обој.

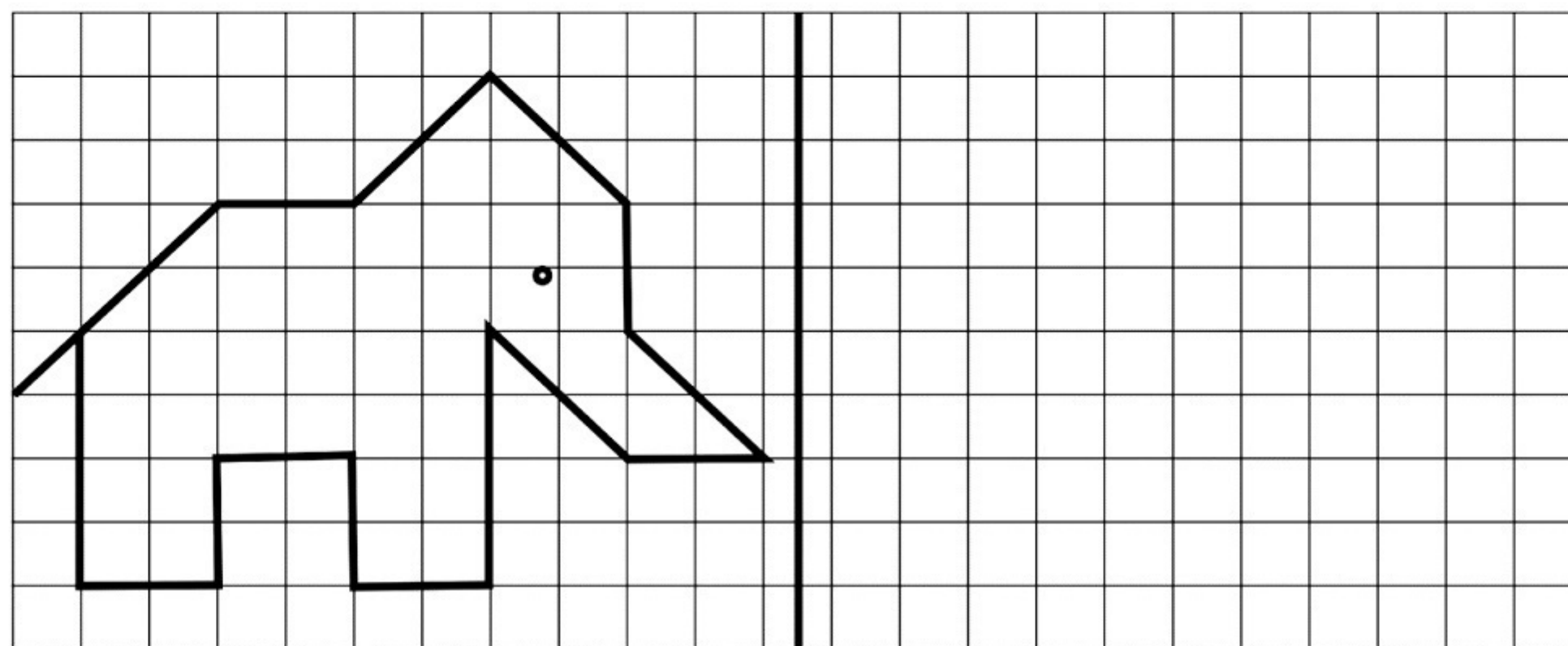

- Подебљај по тачкама.

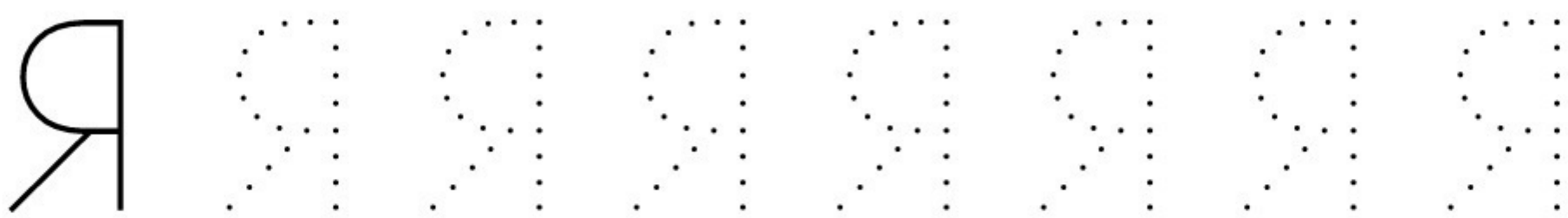

- Пронађи и обој различитим бојама скривена слова.

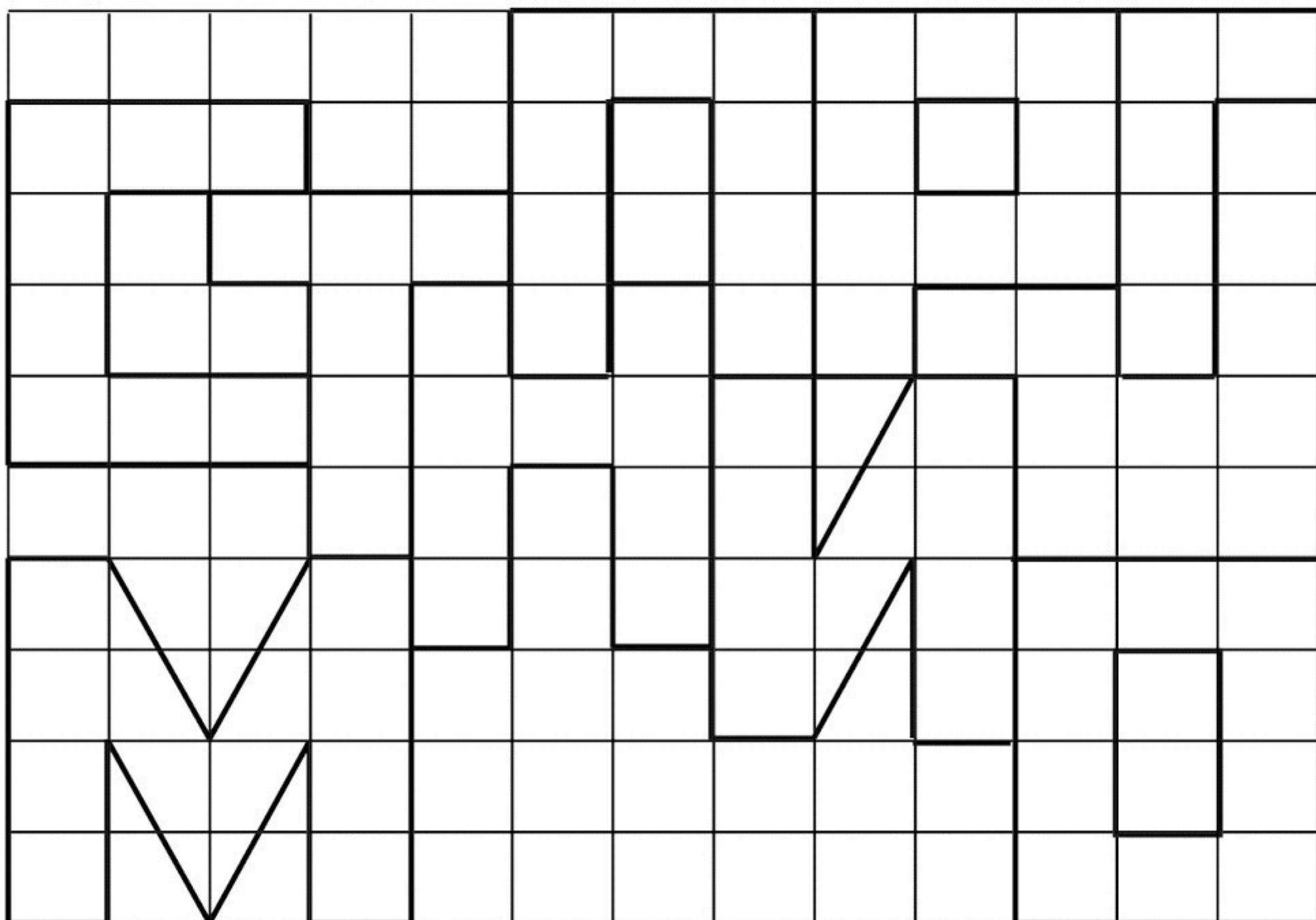

• Уз помоћ лењира нацрај исти цртеж. Обој.

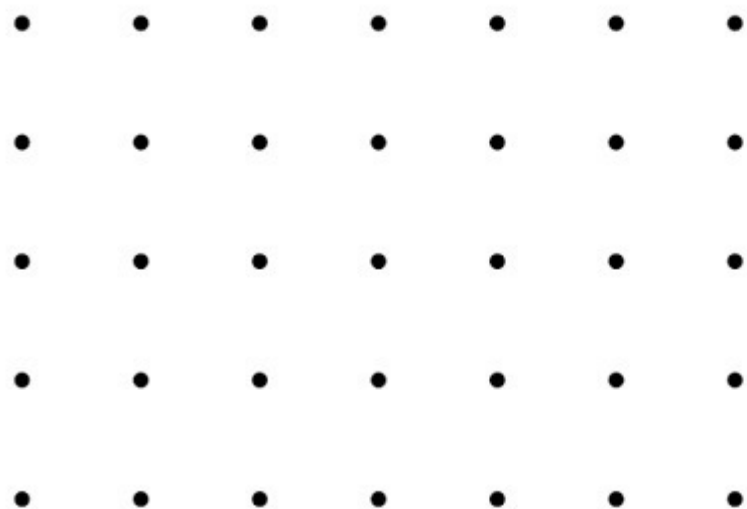
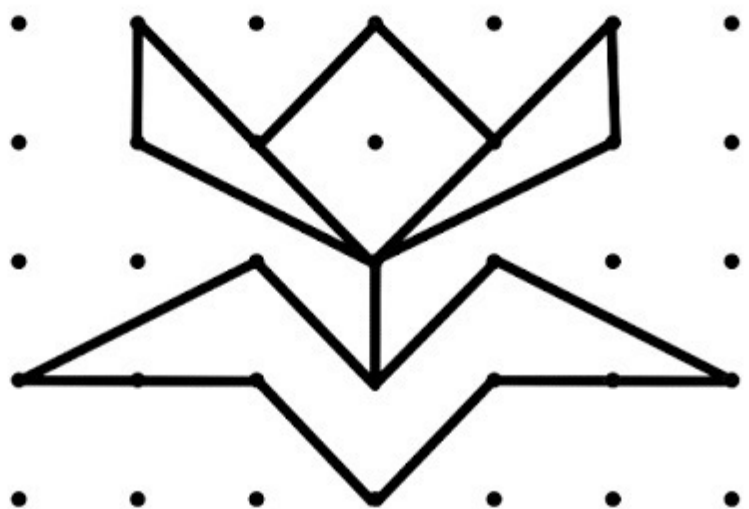
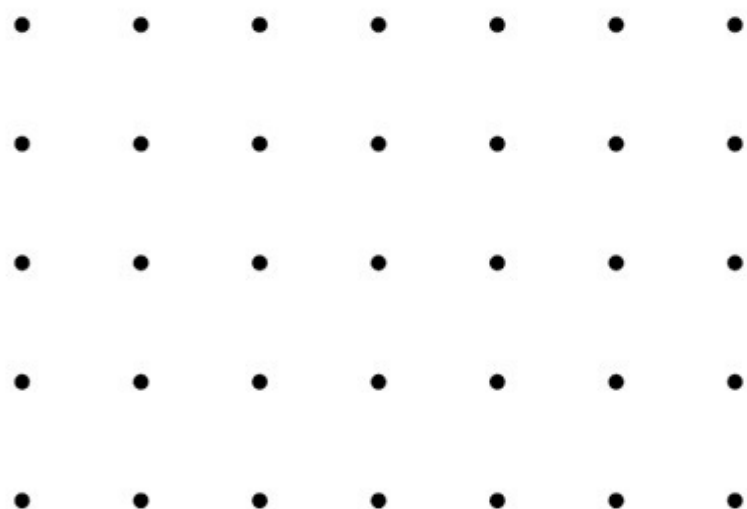
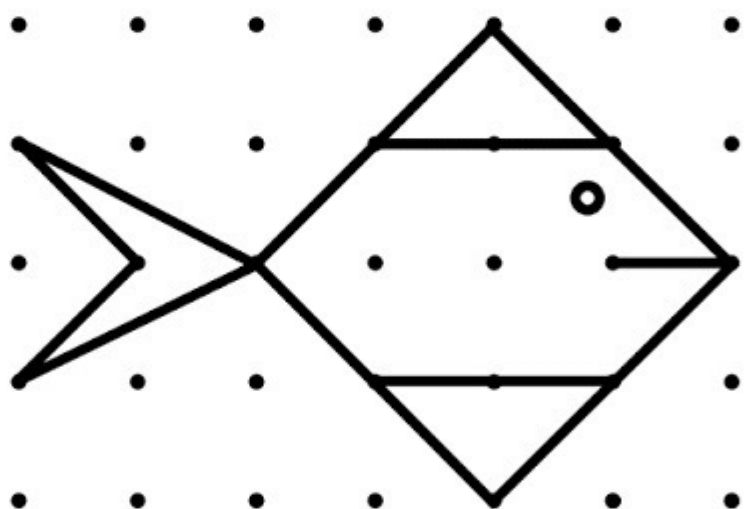
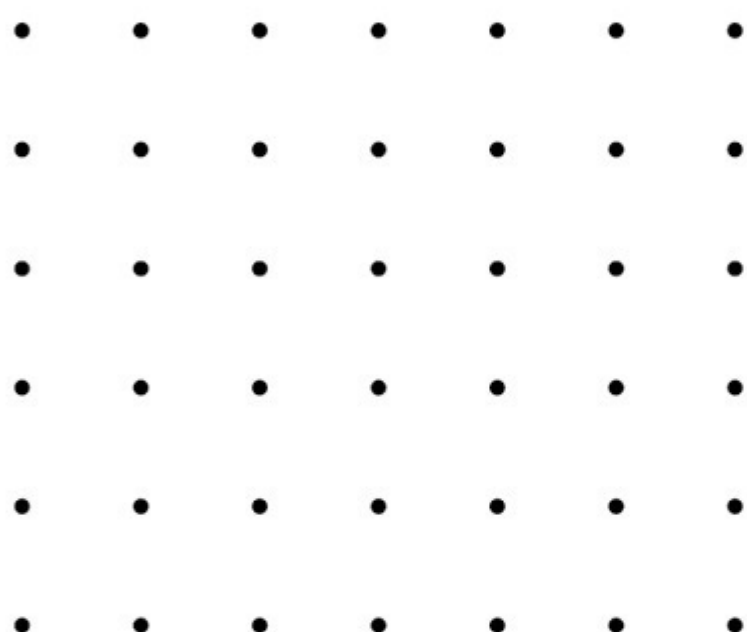
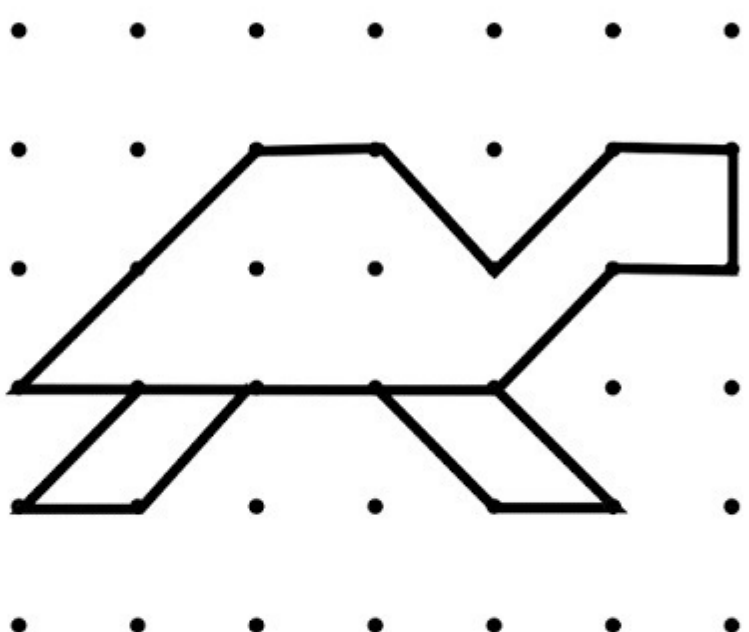
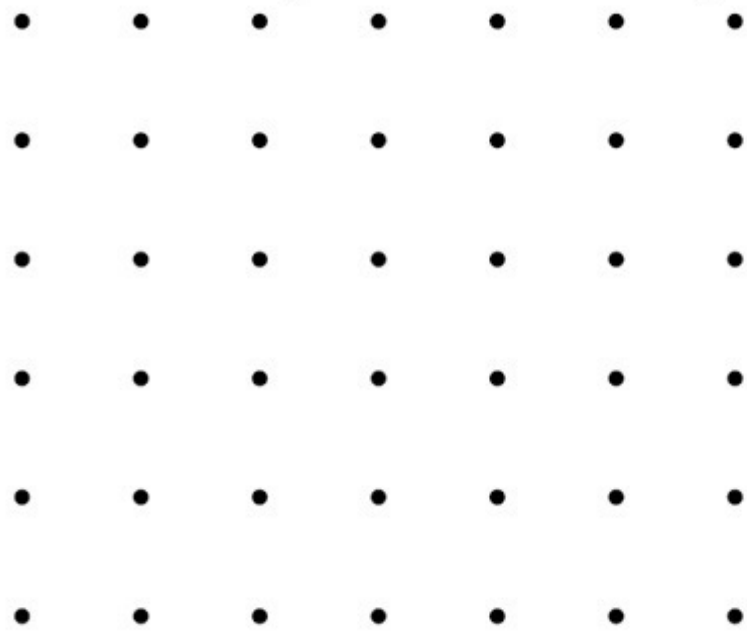
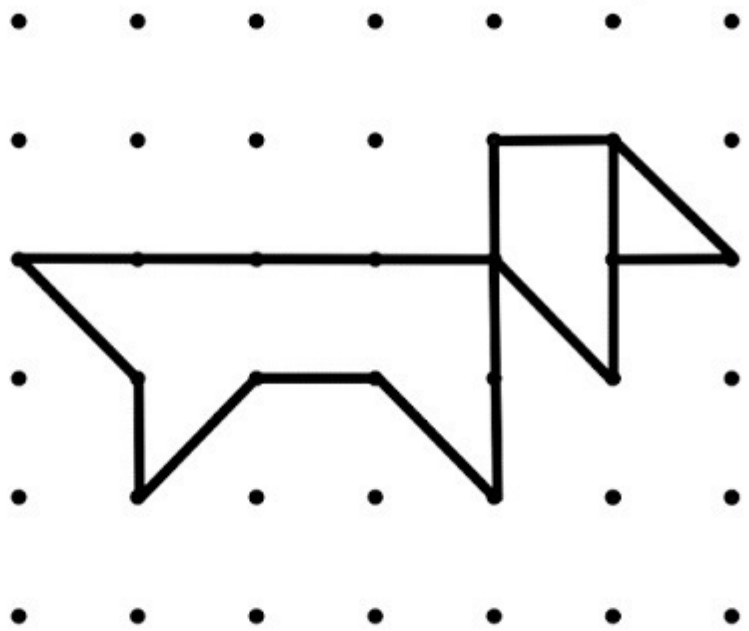

- Подебљљј по тачкицама и обој принцезу.



- Прецртај као слику у огледалу и обој замак.

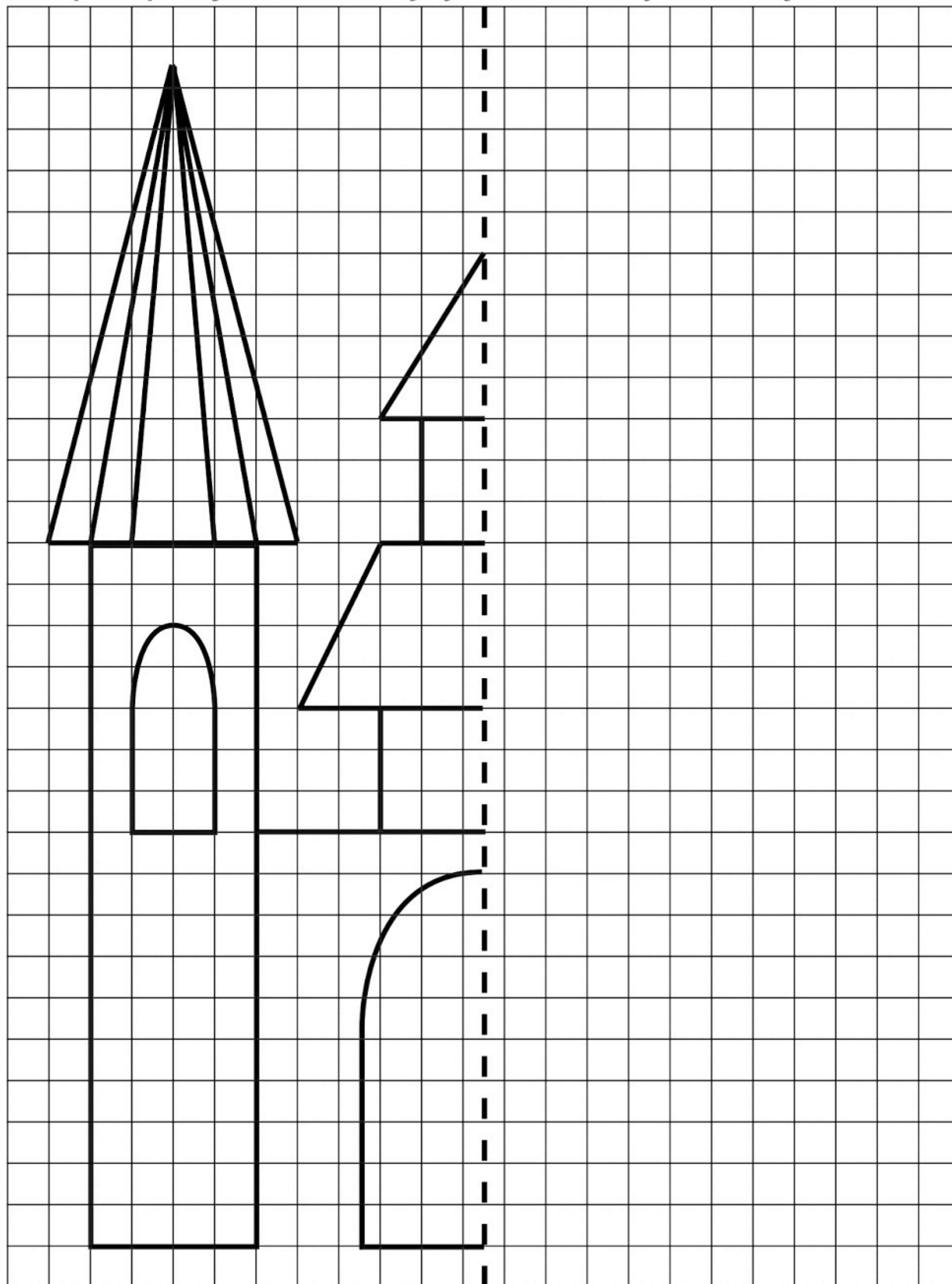

- Прецртај према квадратићима, као слику у огледалу. Обој.

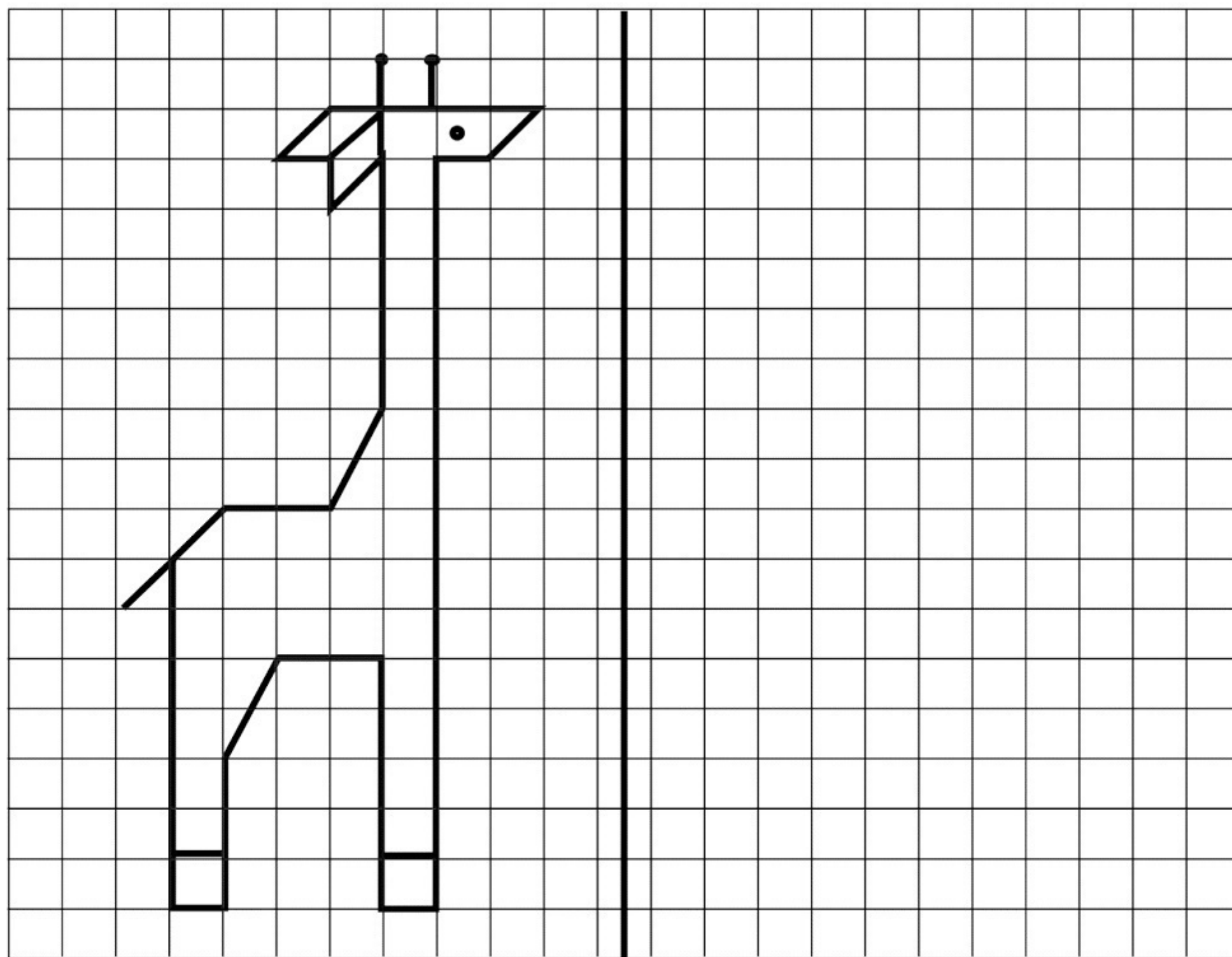

- Подебљај шаре на тепиху. Нацртај исте такве на тепиху десно и обој оба.

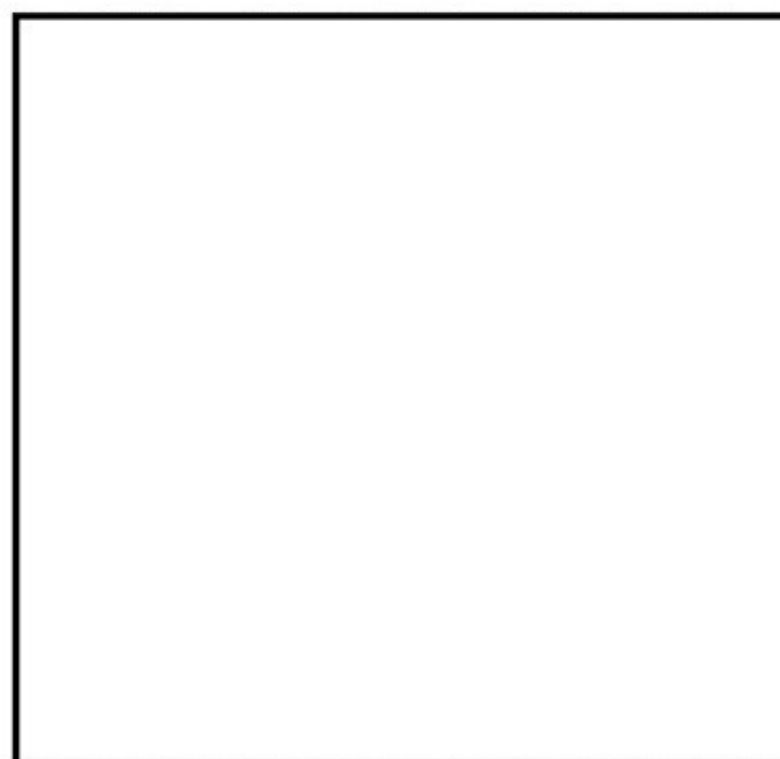
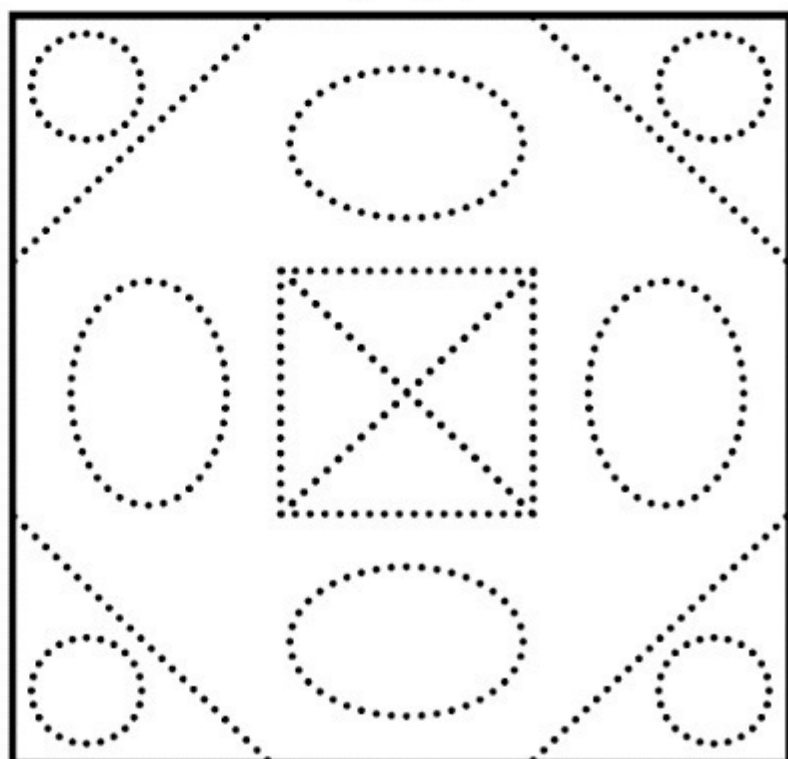

- Доцртај по квадратићима пужа и обој.

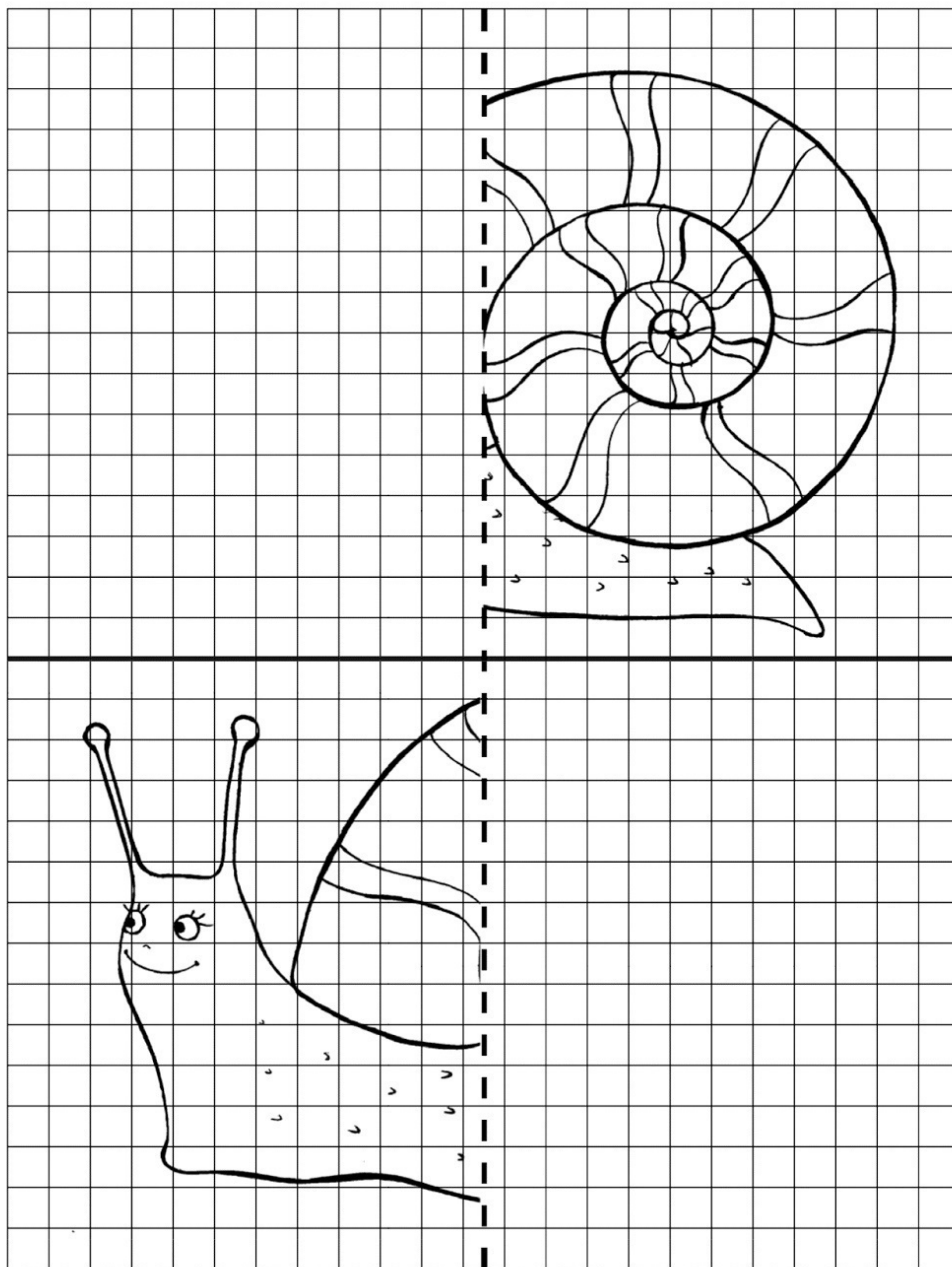

- Повежи све тачке по реду и обој слику.

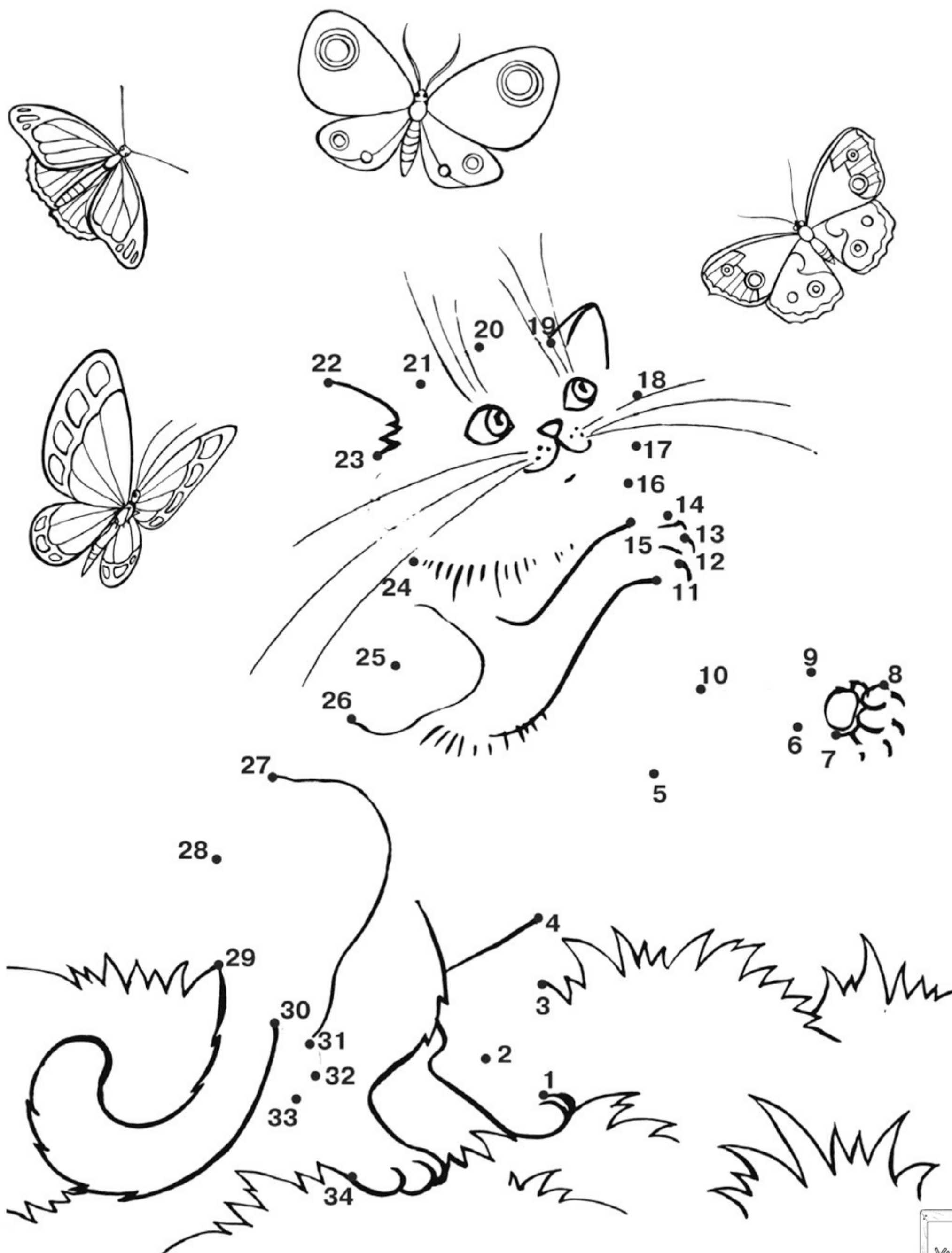

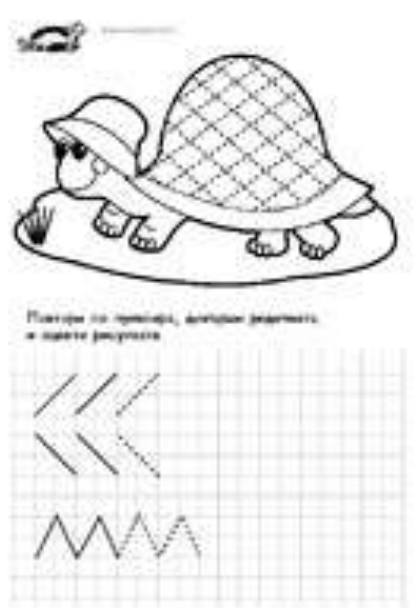
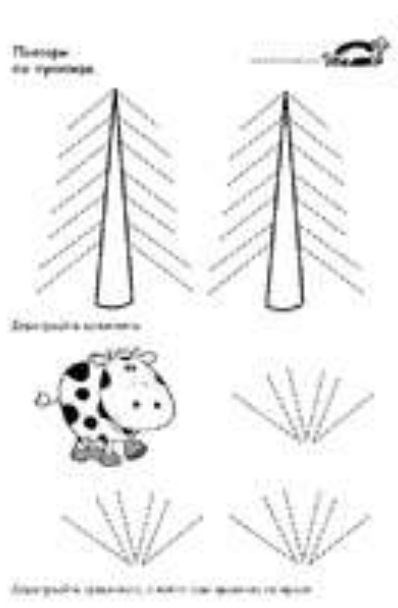
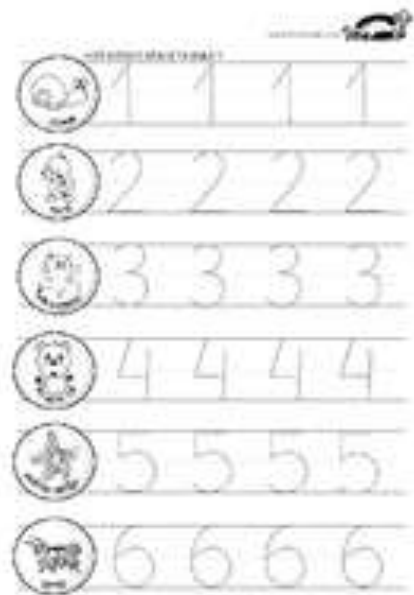
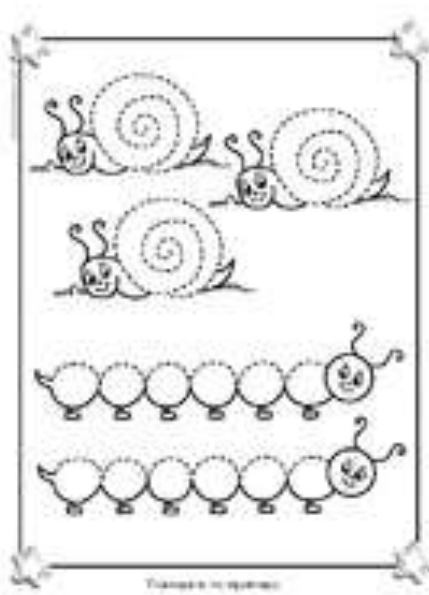
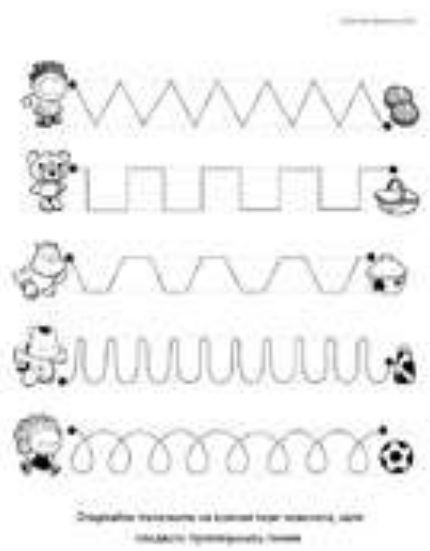
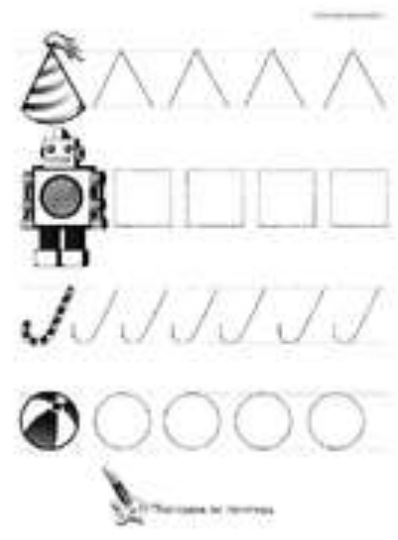
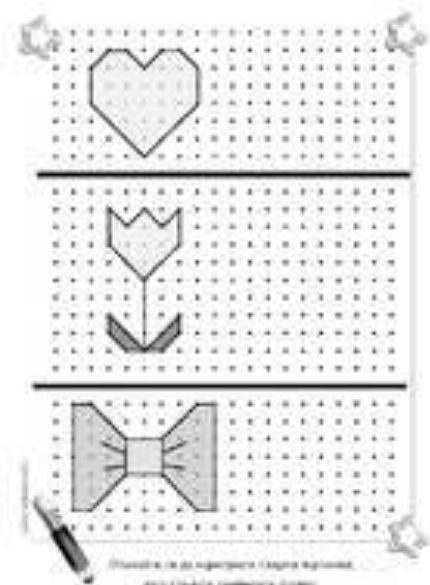
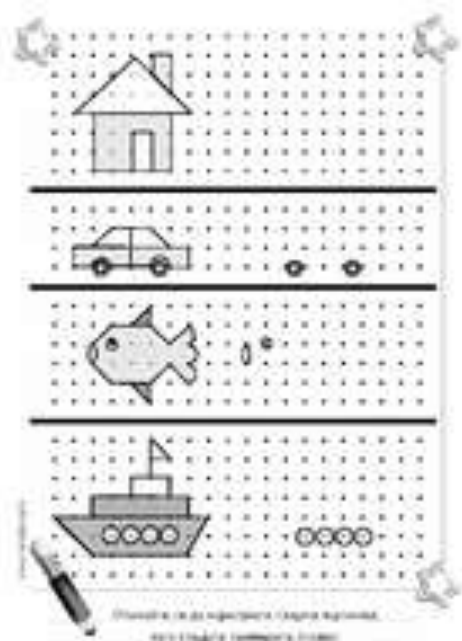



Помоги по примеру, сделать радужку и сделать рисунок

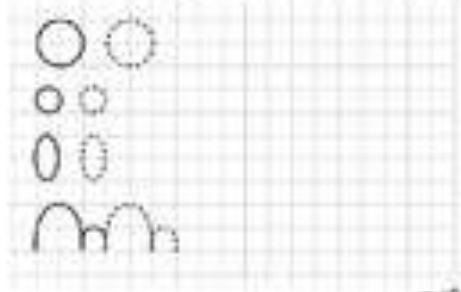

Помоги по примеру, сделать радужку и сделать рисунок

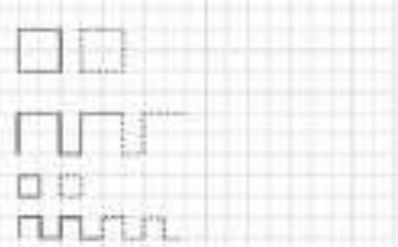

Помоги по примеру и сделать рисунок



Помоги по примеру и сделать рисунок

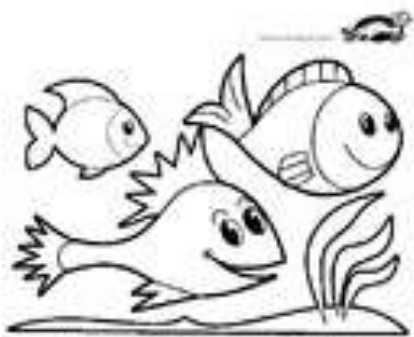
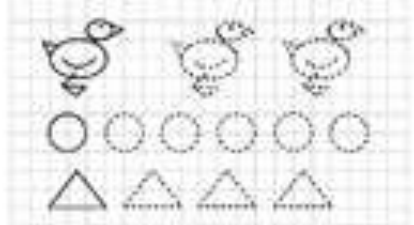

Помоги по примеру и сделать рисунок

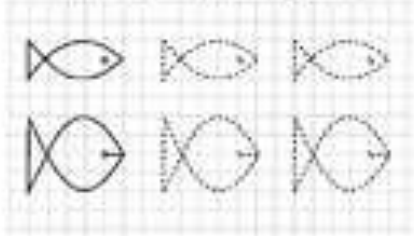

Помоги по примеру и сделать рисунок

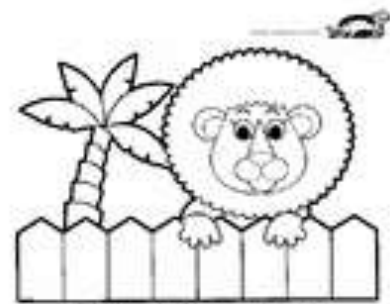
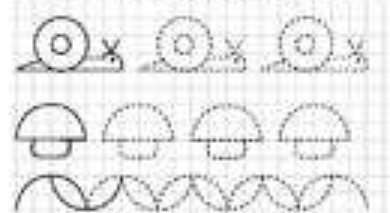

Помоги по примеру и сделать рисунок

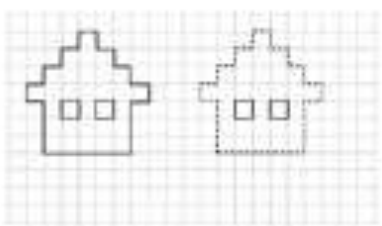

Помоги по примеру и сделать рисунок

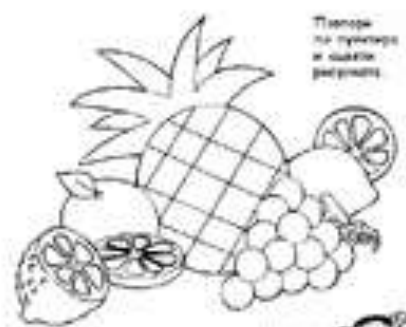
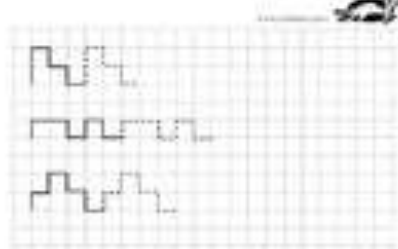

Помоги по примеру и сделать рисунок

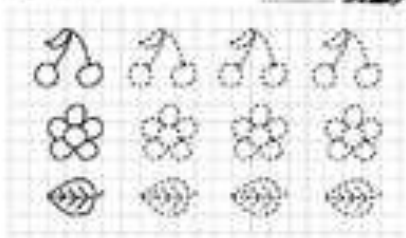



Помоги
по порядку
и сверху
раскрась.

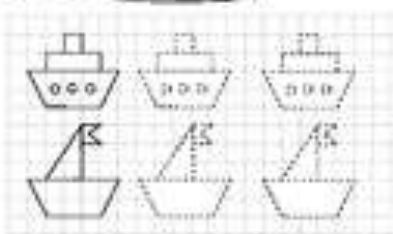

Помоги по порядку
и сверху раскрась.



Помоги по порядку
и сверху раскрась.



Помоги по порядку
и сверху раскрась.



Помоги по порядку
и сверху раскрась.

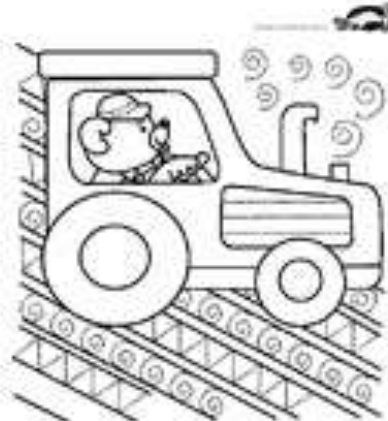

Помоги по порядку
и сверху раскрась.



Помоги по порядку
и сверху раскрась.

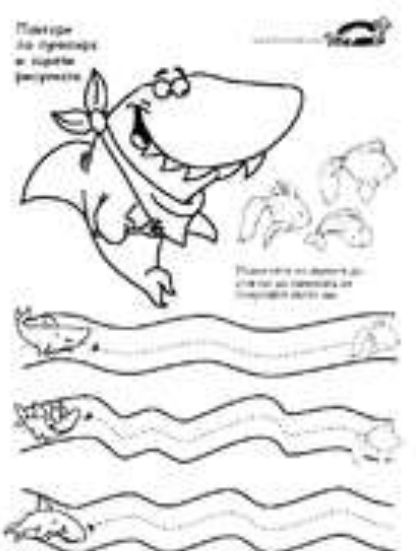

Помоги
по порядку
и сверху
раскрась.

Помоги по порядку
и сверху
раскрась.



Помоги по порядку
и сверху раскрась.



одно

1 1 1 1 1 1 1 1

1



два

2 2 2 2 2

2



3

3 3 3 3 3 3

3



четыре

4 4 4 4 4 4

4



пять

5 5 5 5 5

5



шесть

6 6 6 6 6

6



семь

7 7 7 7 7

7



восемь

8 8 8 8 8

8

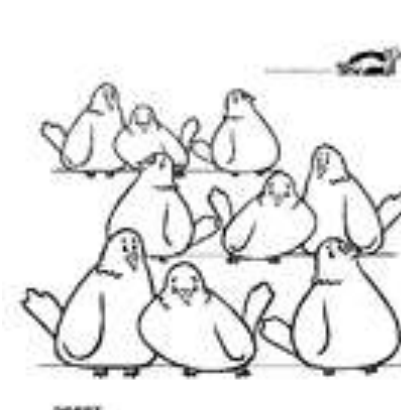

девять

9 9 9 9 9

9

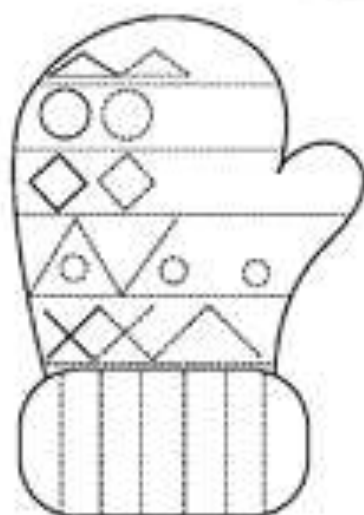

Дополнительные задания на вырезание. Обвести и вырезать.

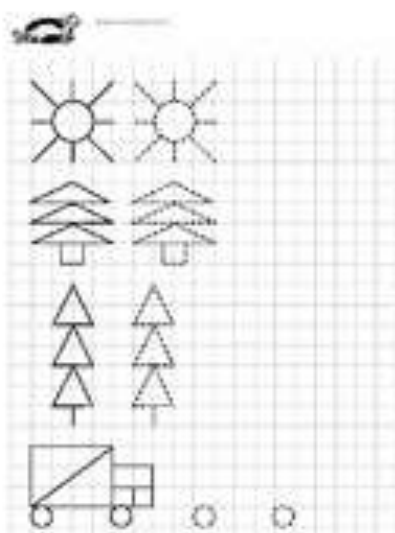

Тренировка по проторе и дальнейшему вырезанию.

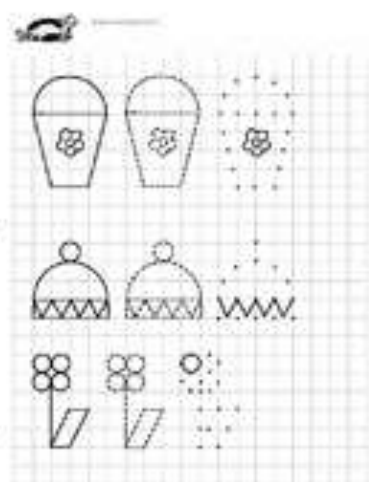

Тренировка по проторе и дальнейшему вырезанию.

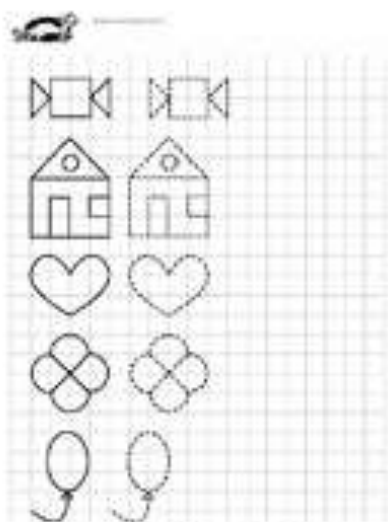

Тренировка по проторе и дальнейшему вырезанию.

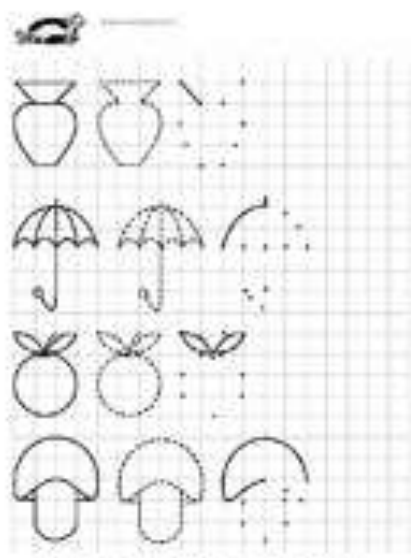

Тренировка по проторе и дальнейшему вырезанию.



Дополнительные задания на вырезание. Обвести и вырезать.

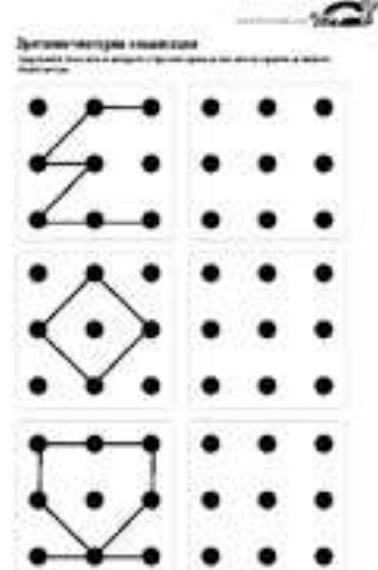
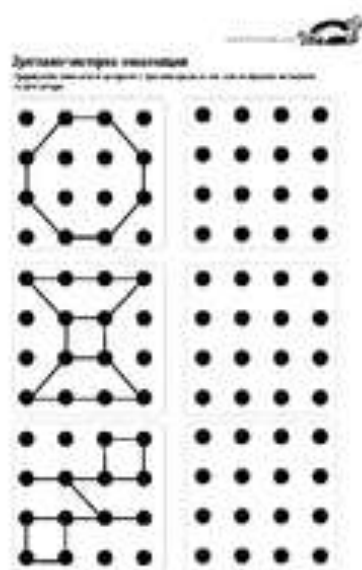
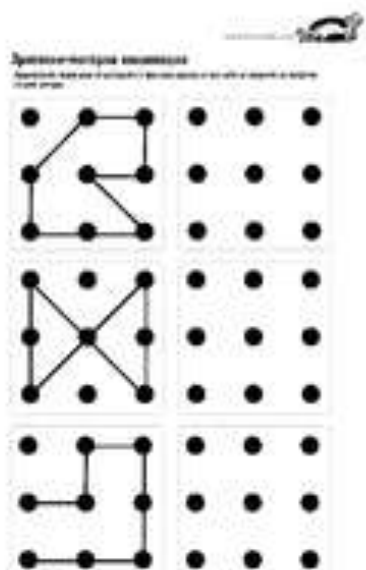

Ucrtaj liniju unutar crta ne podižući olovku s papira

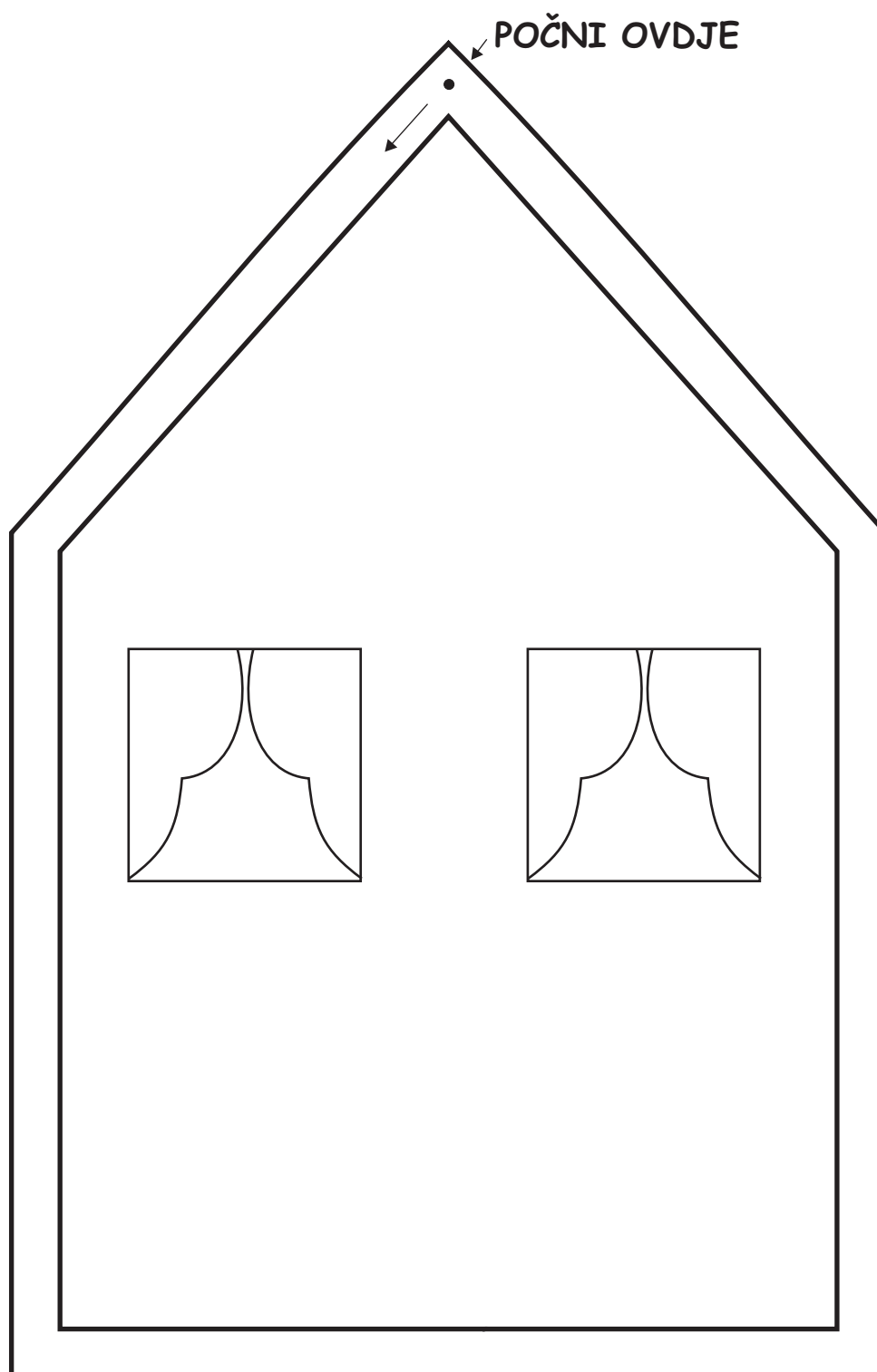

Ucrtaj liniju unutar crta ne podižući olovku s papira



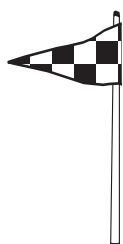
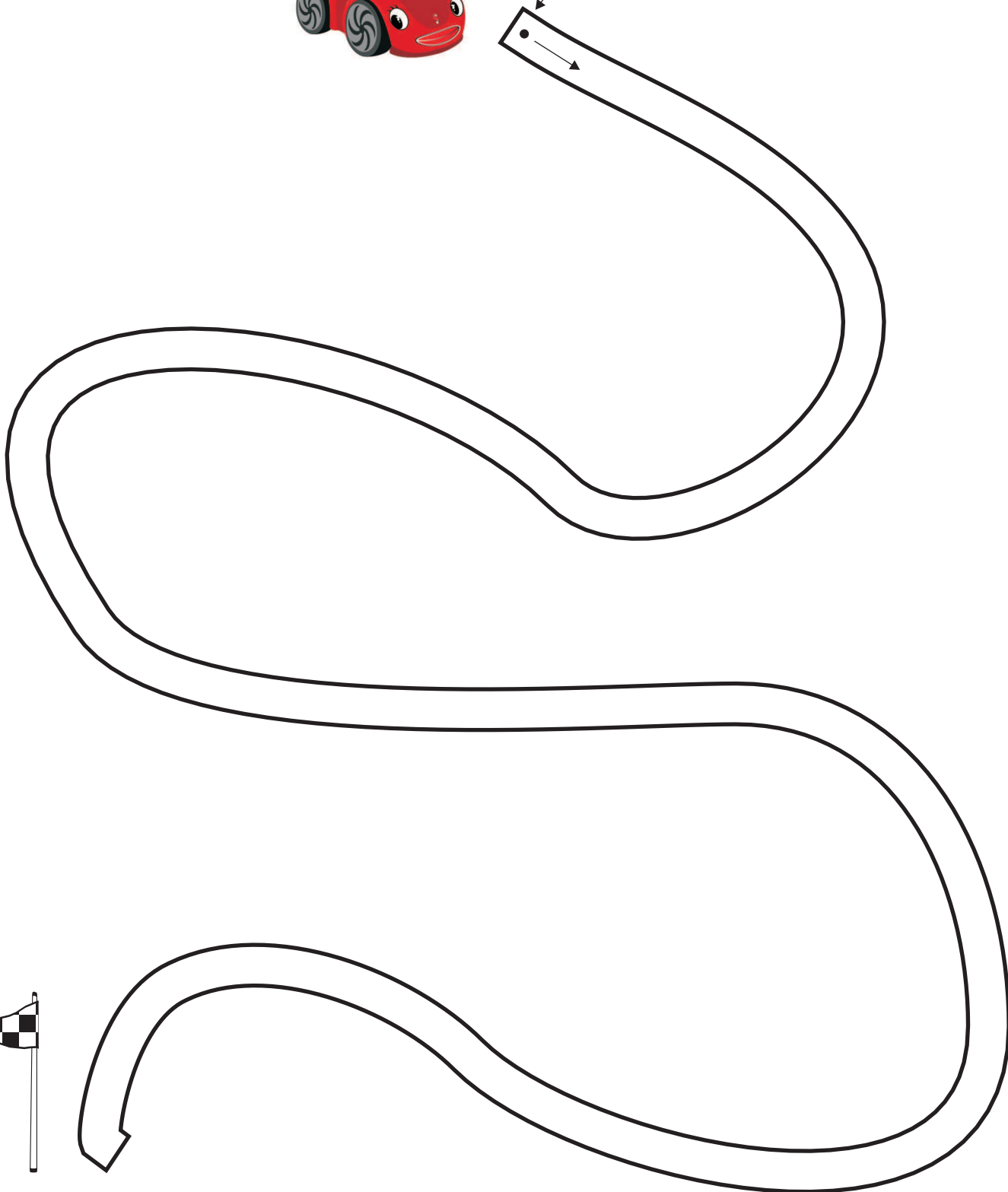

POČNI OVDJE





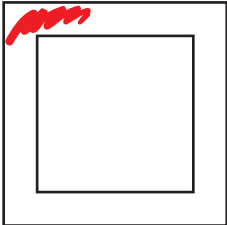
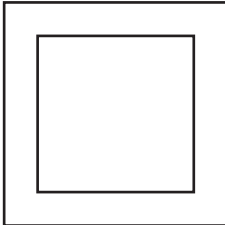
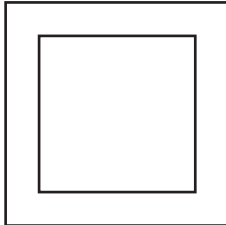
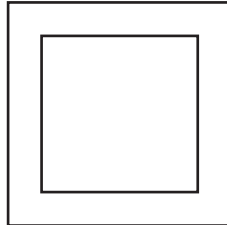
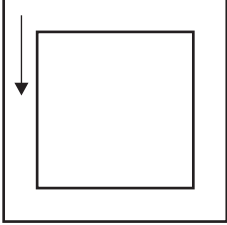
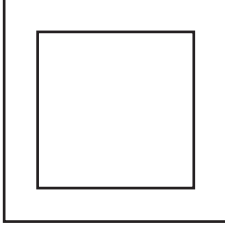
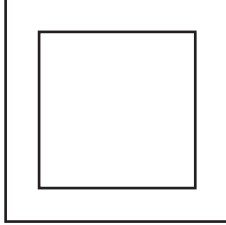
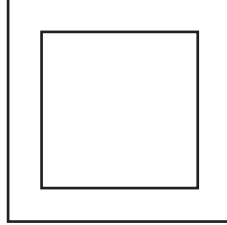
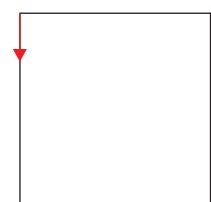
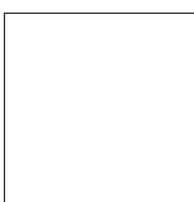
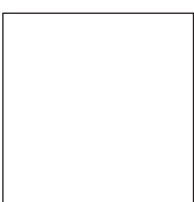
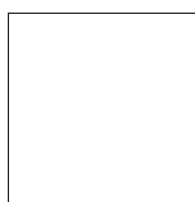
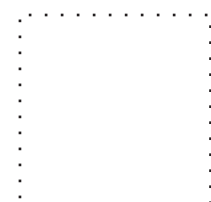

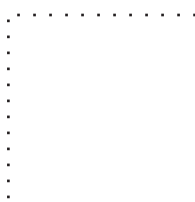
CILJ

OBOJI, UCRTAJ, ISCRTAJ, NACRTAJ

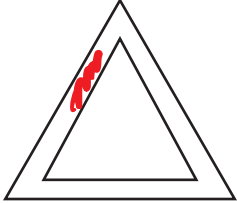
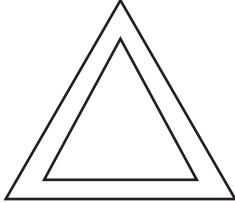
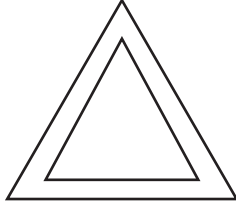
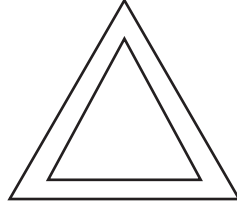
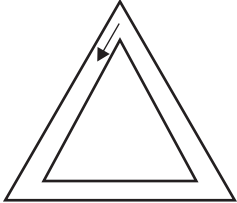
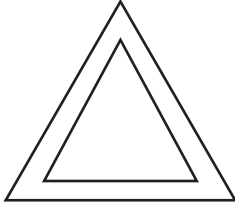
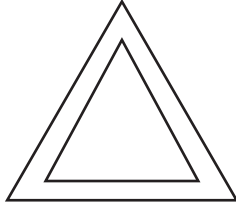
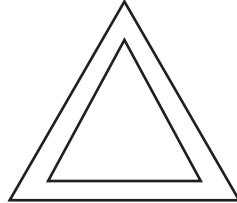
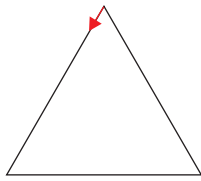
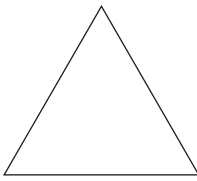
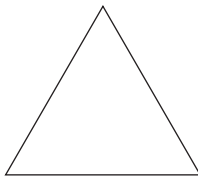
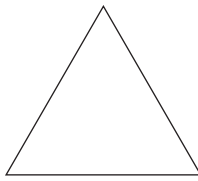
<p>OBOJI UNUTAR CRTA</p>				
<p>UPIŠI CRTU UNUTAR LINIJA</p>				
<p>NACRTAJ KVADRAT PO LINIJI</p>				
<p>NACRTAJ KVADRAT PO TOČKAMA</p>				
<p>NACRTAJ SVOJ KVADRAT</p>				

OBOJI, UCRTAJ, ISCRTAJ, NACRTAJ

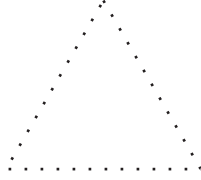
<p>OBOJI UNUTAR CRTA</p>				
<p>UPIŠI CRTU UNUTAR LINIJA</p>				
<p>NACRTAJ TROKUT PO LINIJI</p>				
<p>NACRTAJ TROKUT PO TOČKAMA</p>				
<p>NACRTAJ SVOJ TROKUT</p>				

OBOJI, UCRTAJ, ISCRTAJ, NACRTAJ

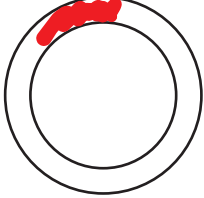
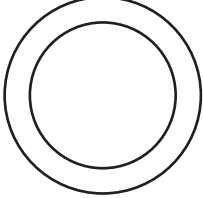
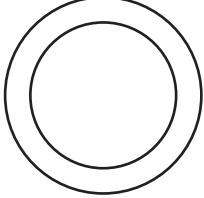
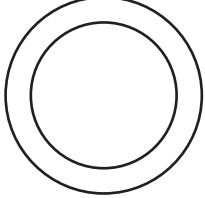
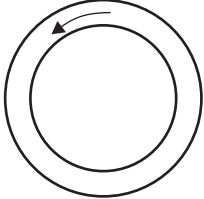
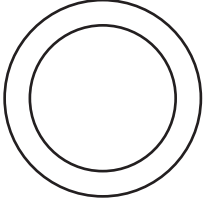
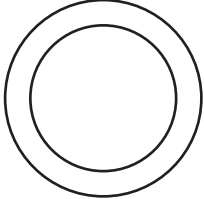
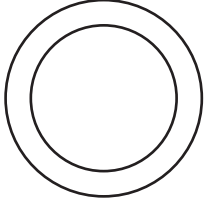
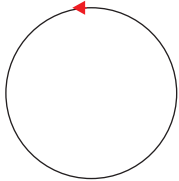
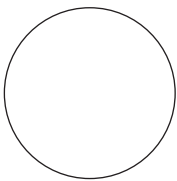
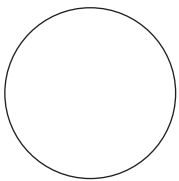
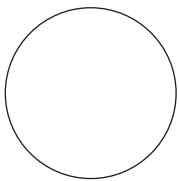
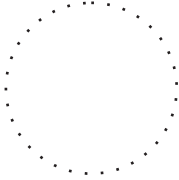
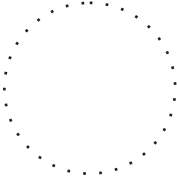
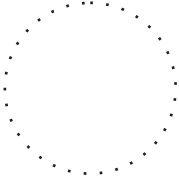
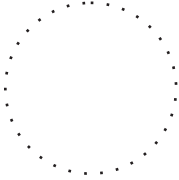
OBOJI UNUTAR CRTA				
UPIŠI CRTU UNUTAR LINIJA				
NACRTAJ KRUG PO LINIJI				
NACRTAJ KRUG PO TOČKAMA				
NACRTAJ SVOJ KRUG				

OBOJI, UCRTAJ, ISCRTAJ, NACRTAJ

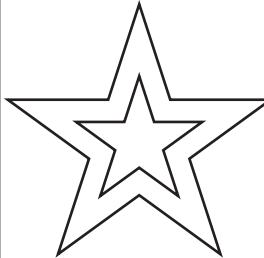
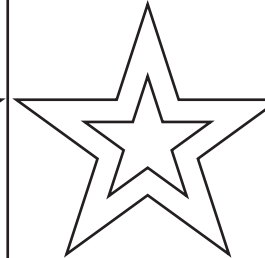
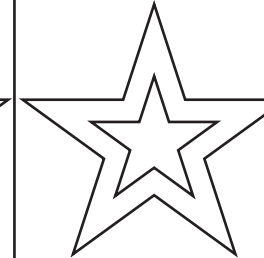
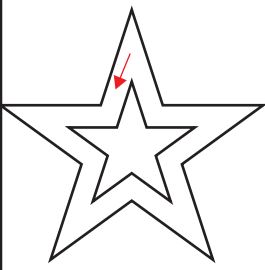
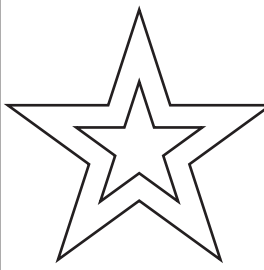
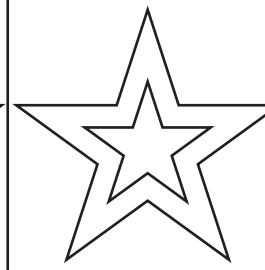
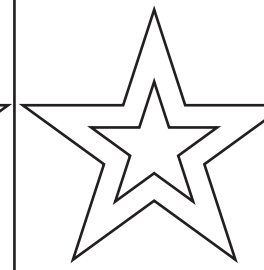
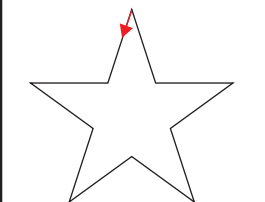
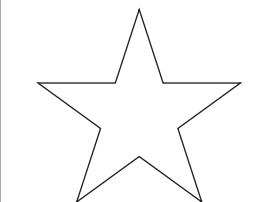
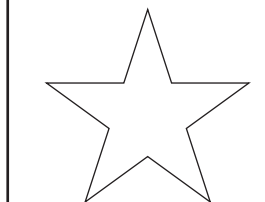
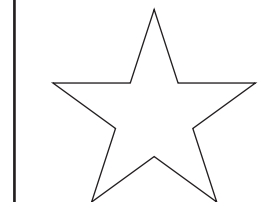
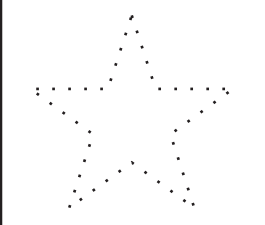
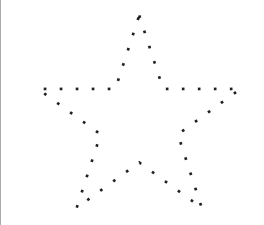
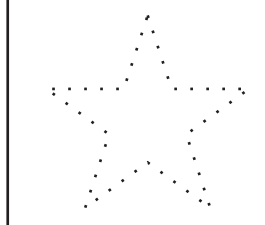
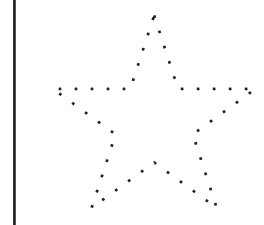
<p>OBOJI UNUTAR CRTA</p>				
<p>UPIŠI CRTU UNUTAR LINIJA</p>				
<p>NACRTAJ ZVIJEZDU PO LINIJI</p>				
<p>NACRTAJ ZVIJEZDU PO TOČKAMA</p>				
<p>NACRTAJ SVOJU ZVIJEZDU</p>				

OBOJI, UCRTAJ, ISCRTAJ, NACRTAJ

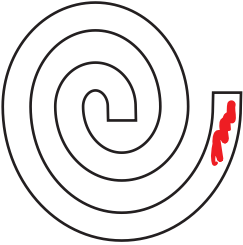
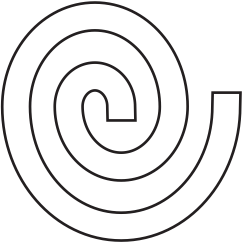
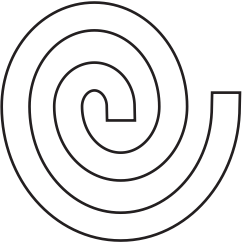
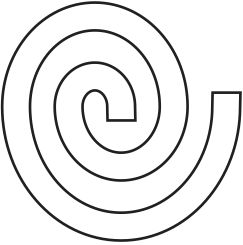
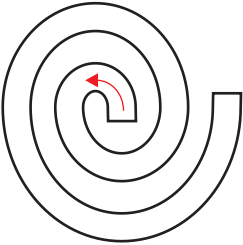
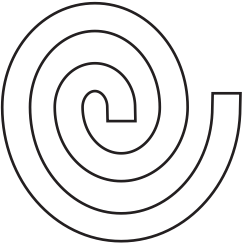
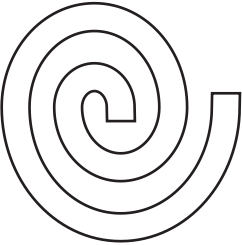
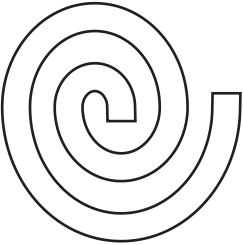
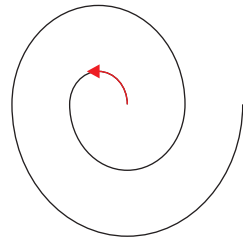
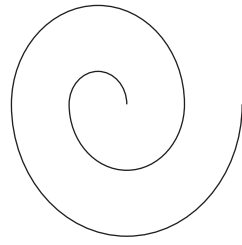
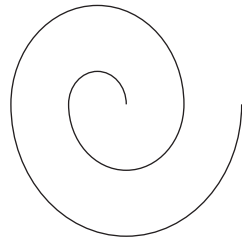
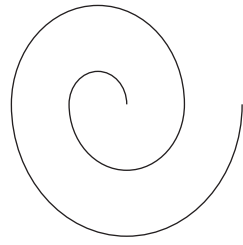
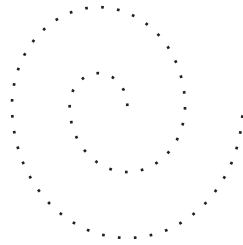
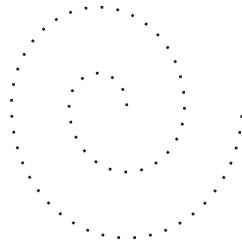
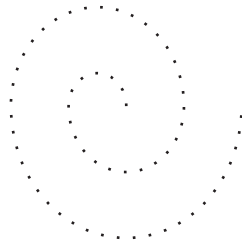
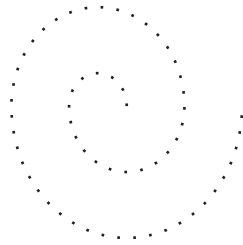
OBOJI UNUTAR CRTA				
UPIŠI CRTU UNUTAR LINIJA				
NACRTAJ SPIRALU PO LINIJI				
NACRTAJ SPIRALU PO TOČKAMA				
NACRTAJ SVOJU SPIRALU				

**Iscrtaj svaku liniju olovkom
držeći olovku na papiru bez podizanja**

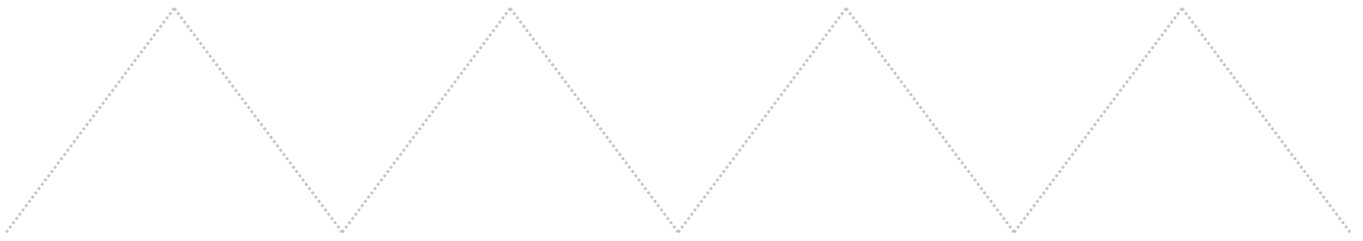

Ucrtaj put između linija.

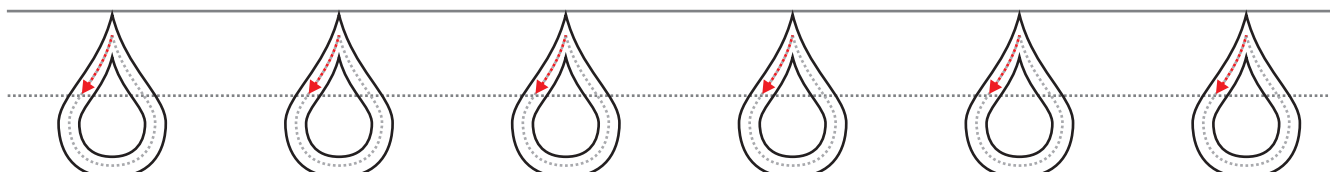
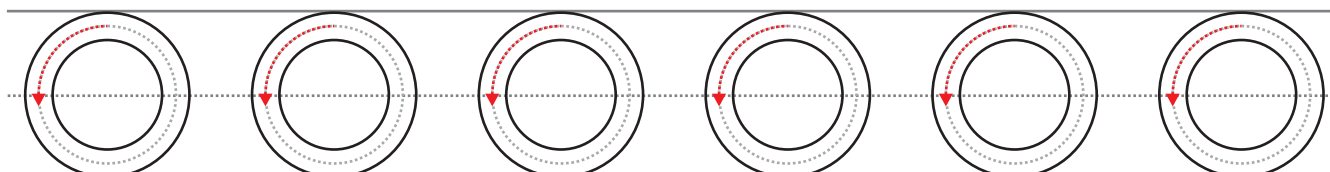
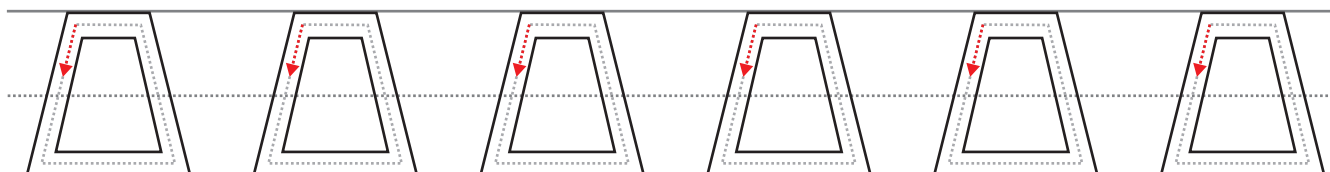
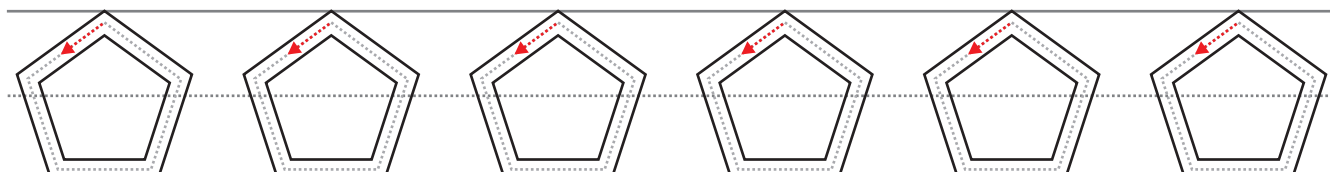
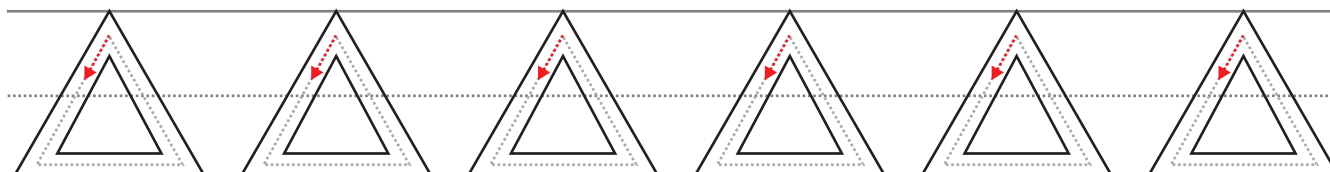
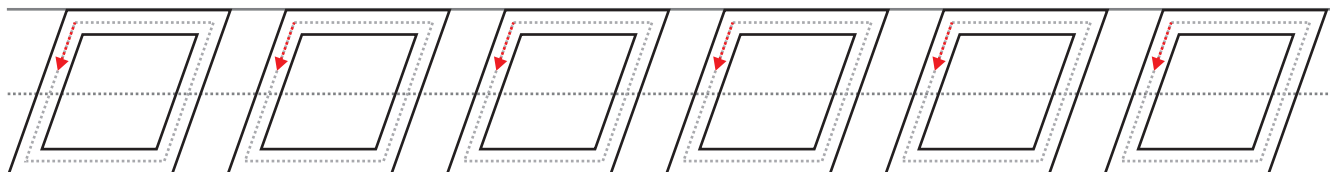
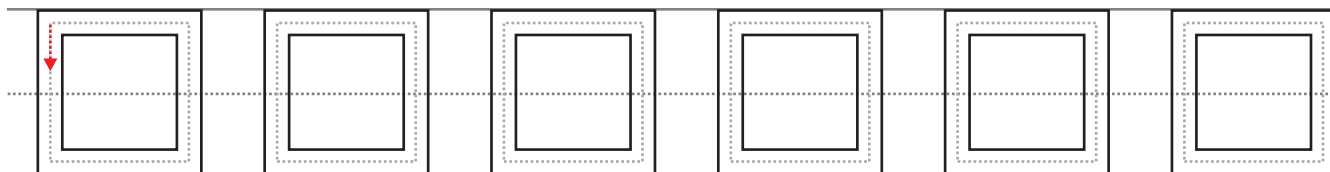

Ucrtaj put između linija.

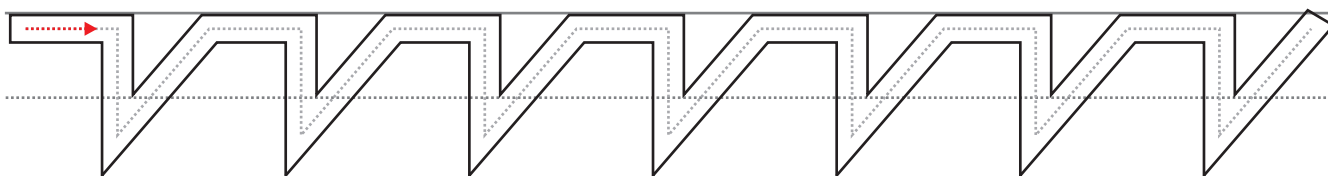
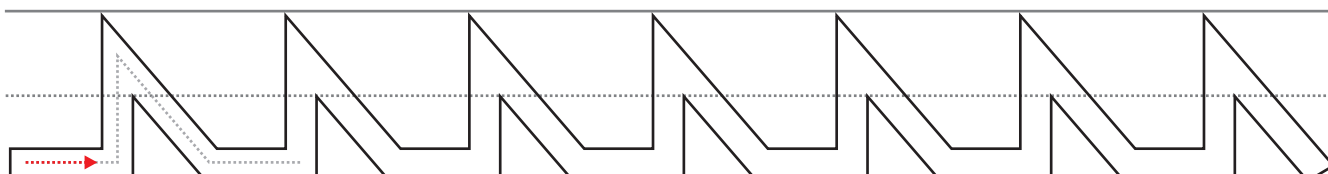
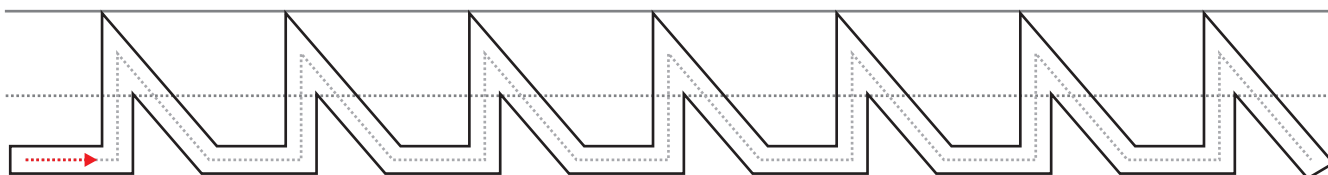
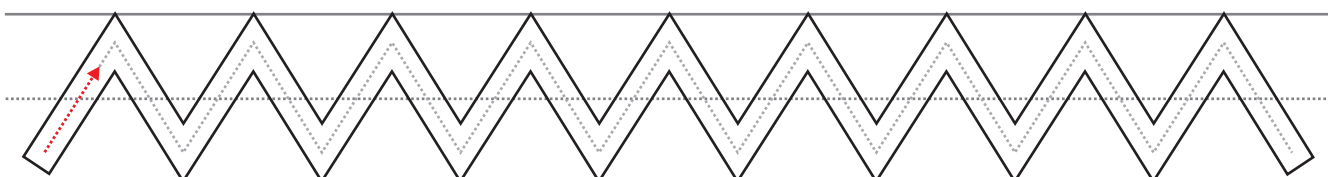
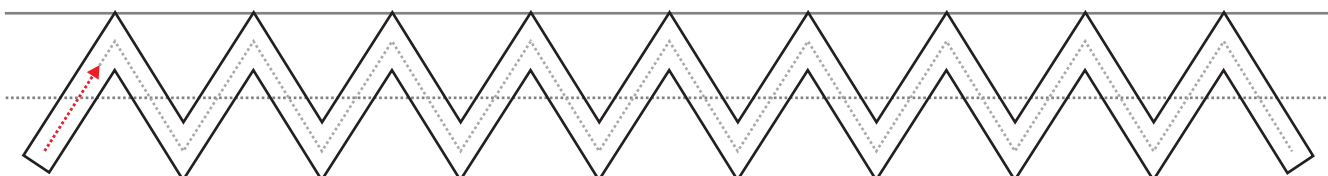
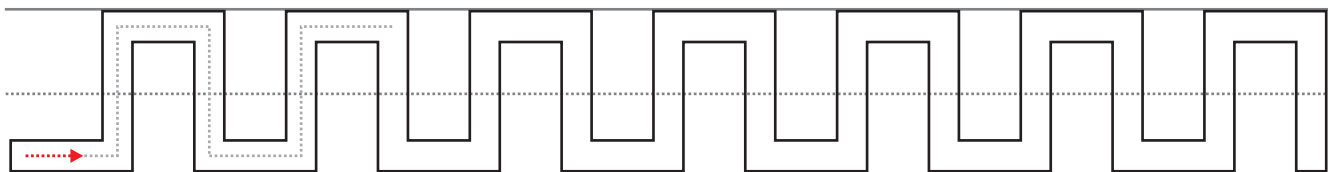
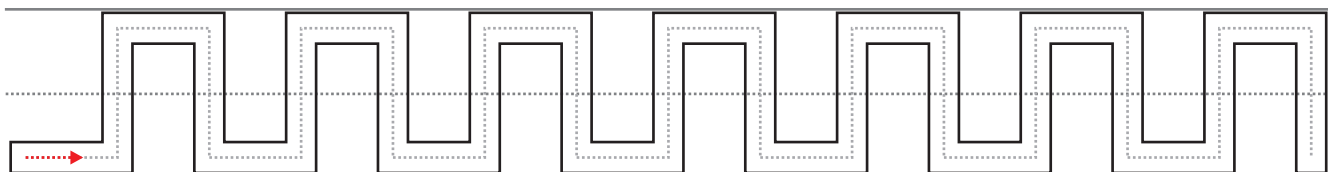

Ucrtaj put između linija.

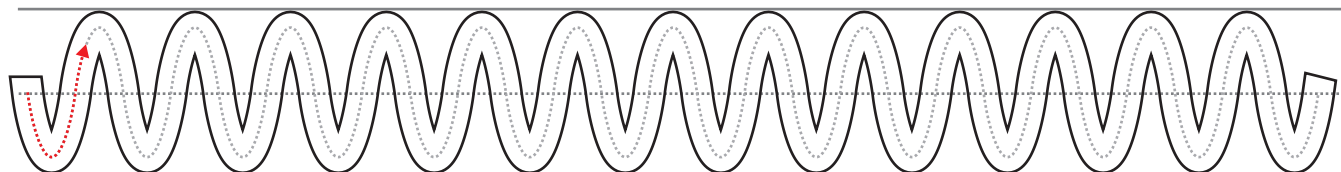
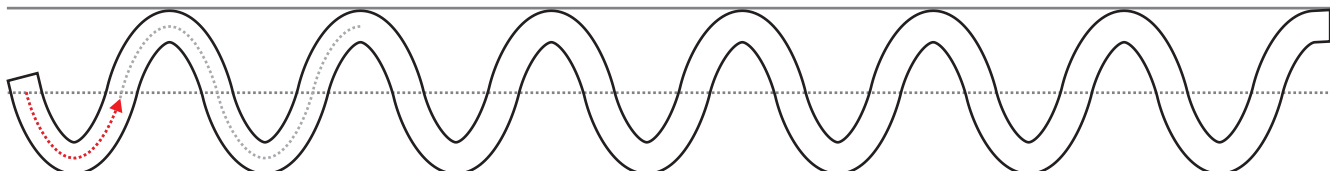
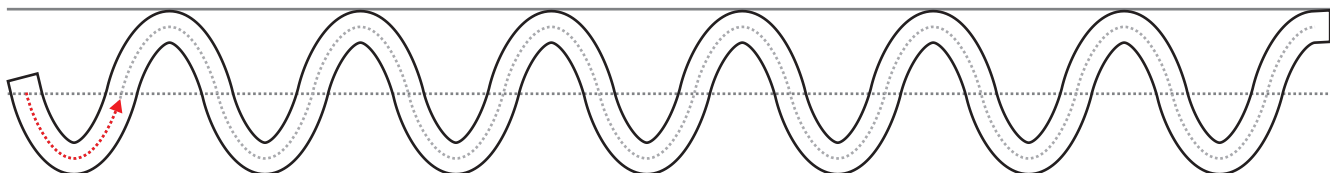
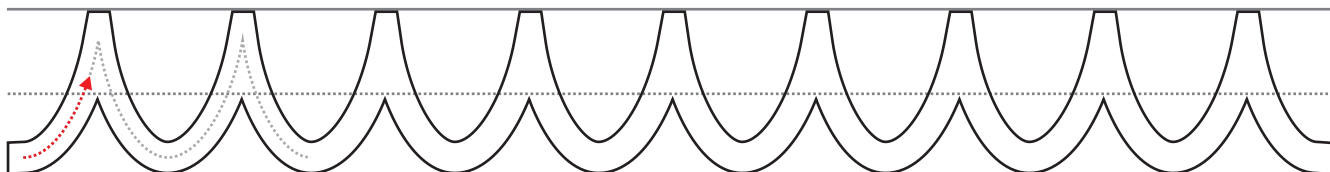
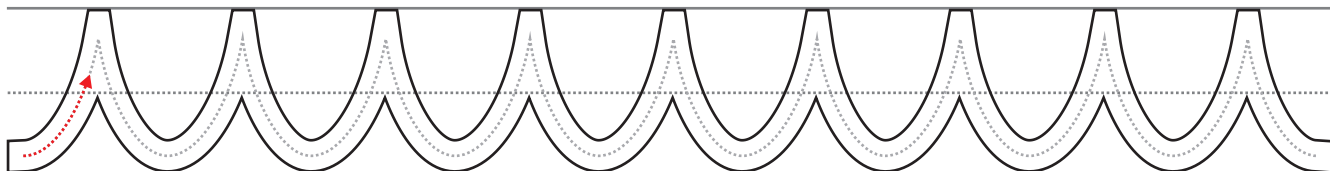
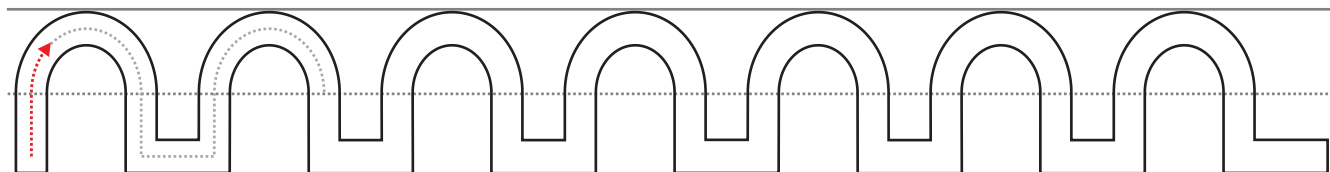
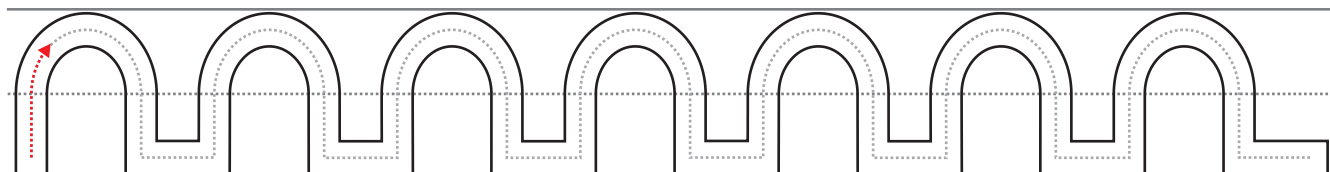

CRTANJE PO ZADANOM PREDLOŠKU

Potrebno je dovršiti crtanje lika zrcalno kopirajući sliku s lijeve strane, orijentirajući se prema kvadratićima.

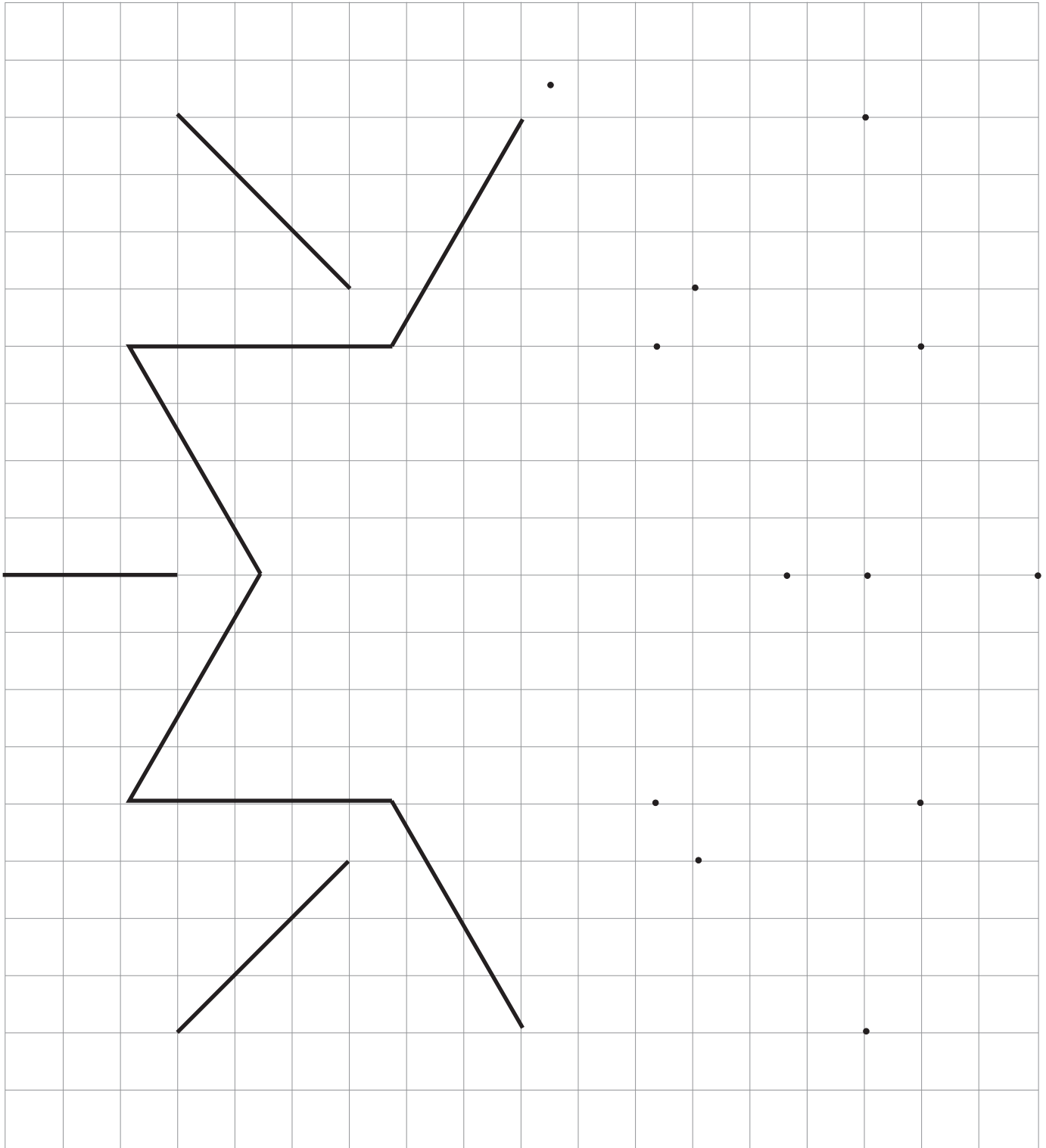

CRTANJE PO ZADANOM PREDLOŠKU

Prvo podebljaj sve isprekidane linije, a zatim precrtaj crvenu liniju s desne na lijevu stranu.

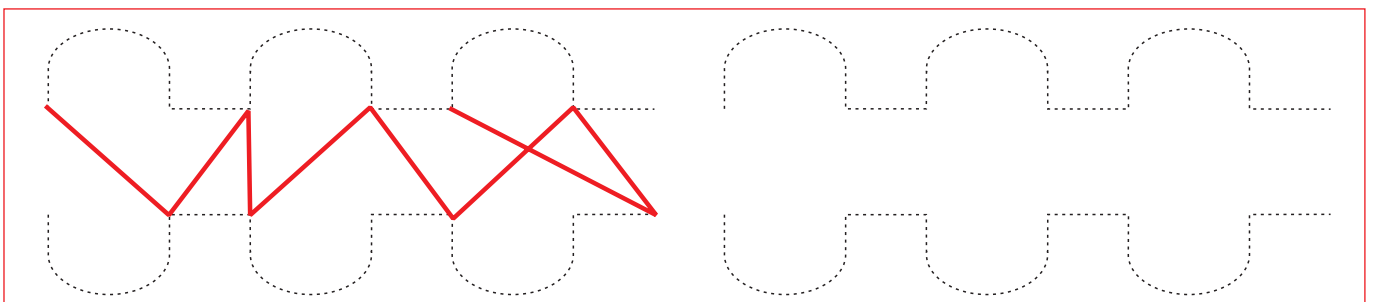
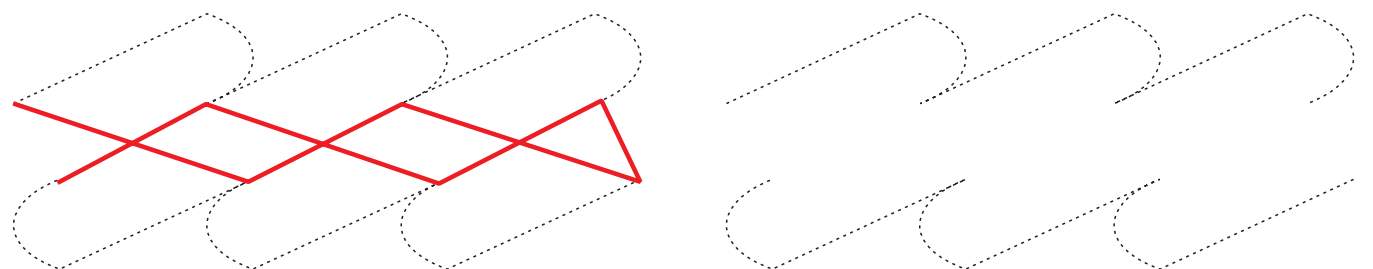
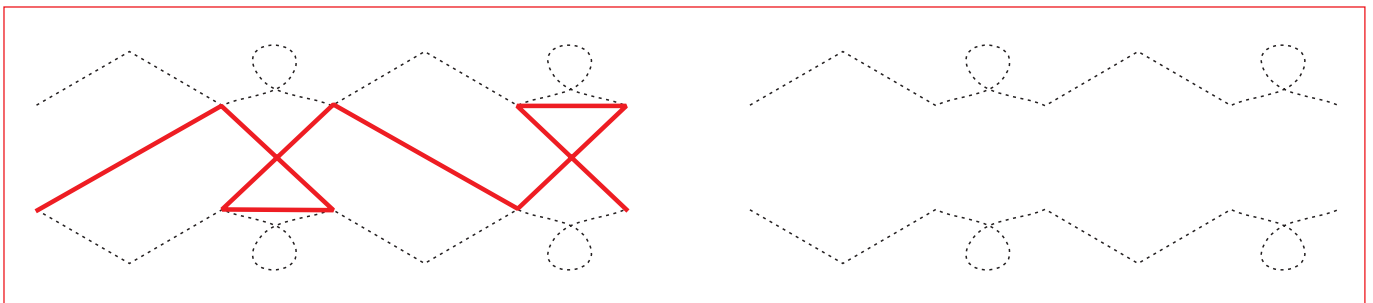
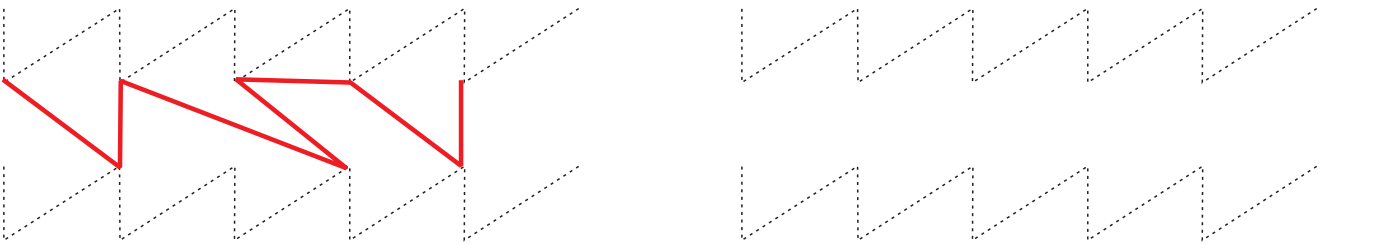
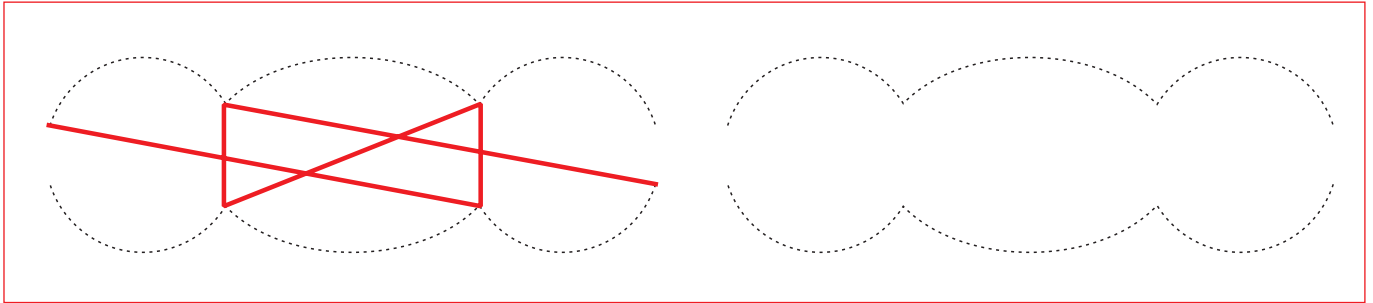

CRTANJE PO ZADANOM PREDLOŠKU

Prvo podebljaj iscrtkane linije, a zatim nastavi spajati točkice na isti način.
Pazi na smjer povlačenja olovke (bojice).

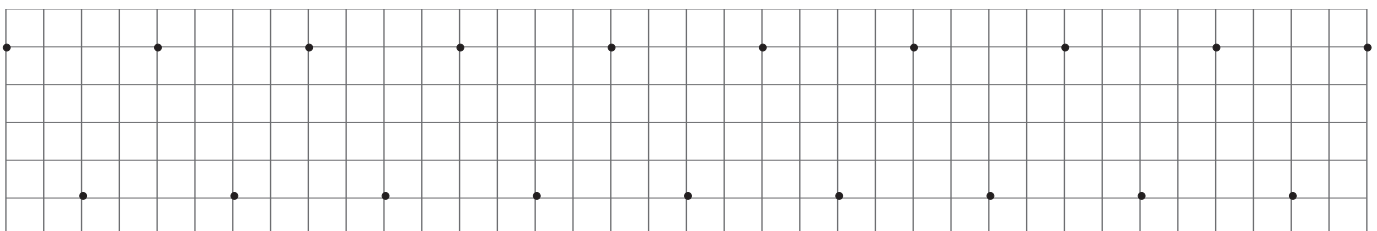
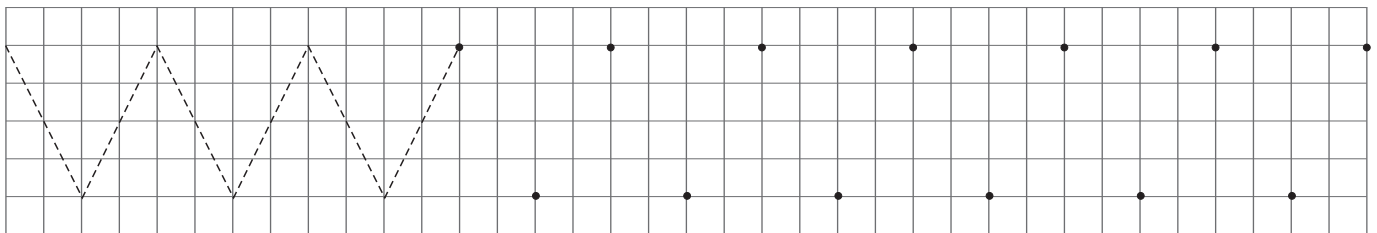
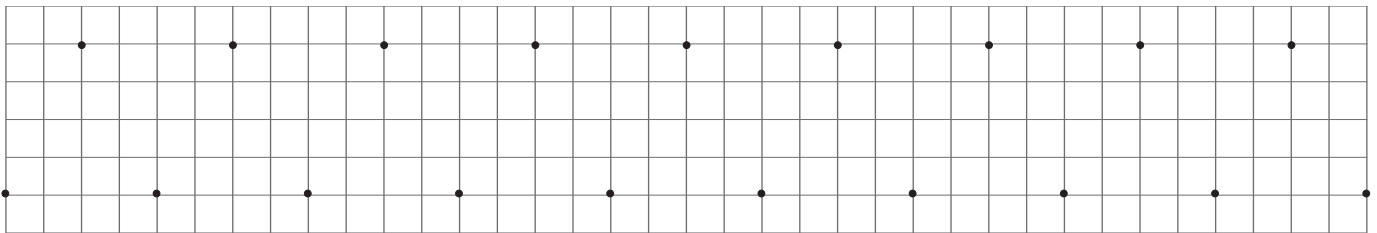
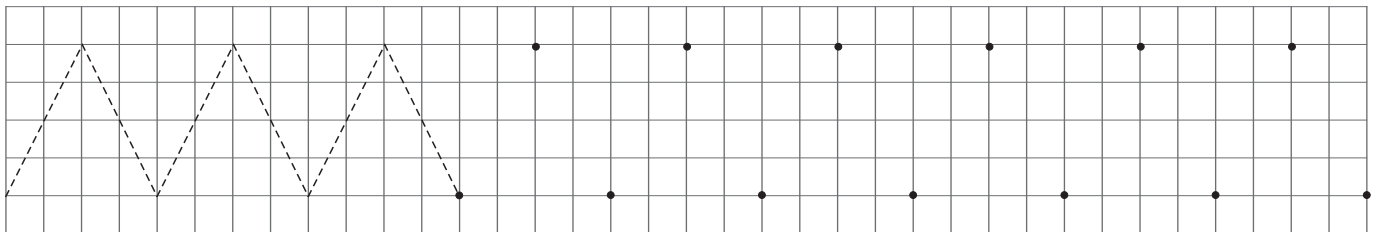
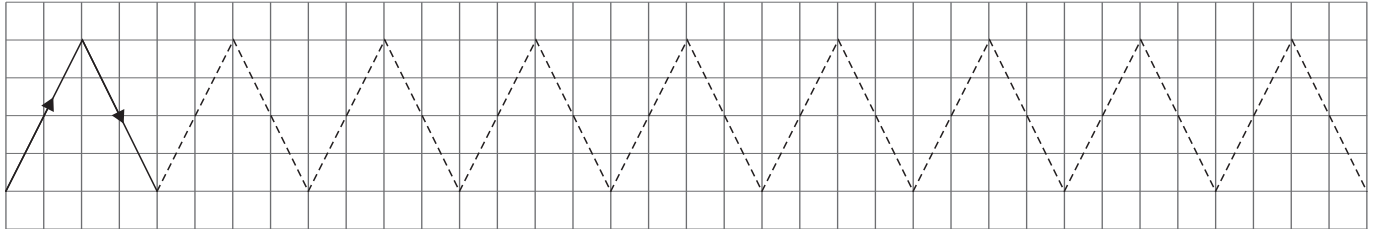

CRTANJE PO ZADANOM PREDLOŠKU

Prvo podebljaj iscrtkane linije, a zatim nastavi spajati točkice na isti način.
Pazi na smjer povlačenja olovke (bojice).

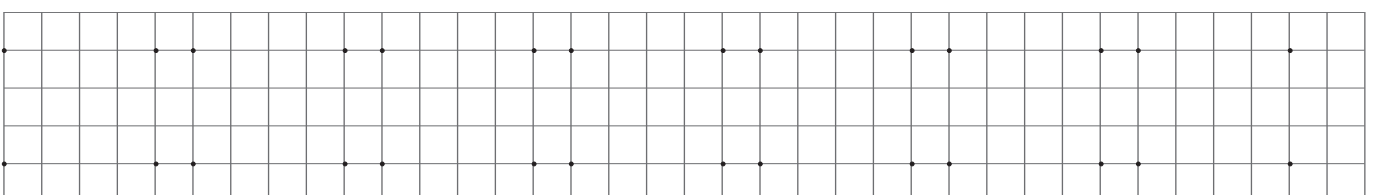
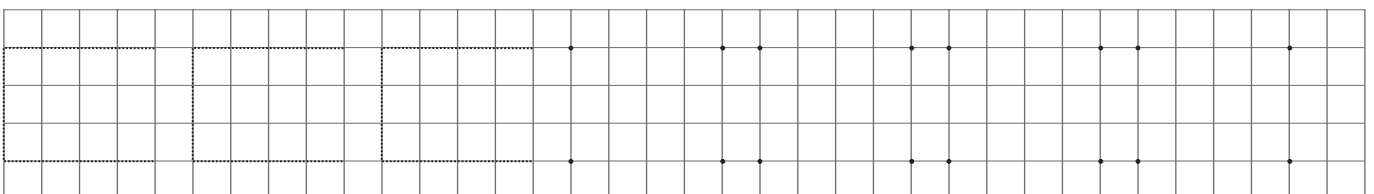
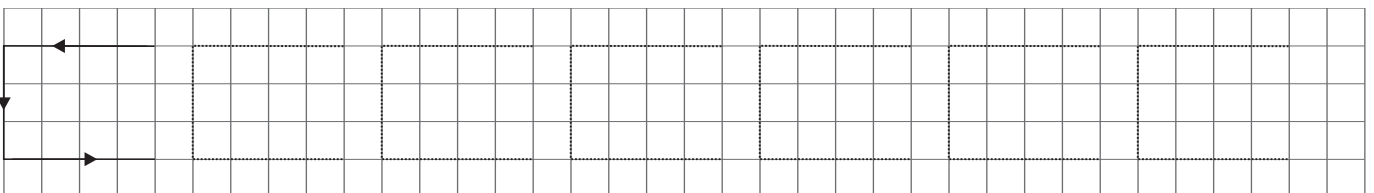
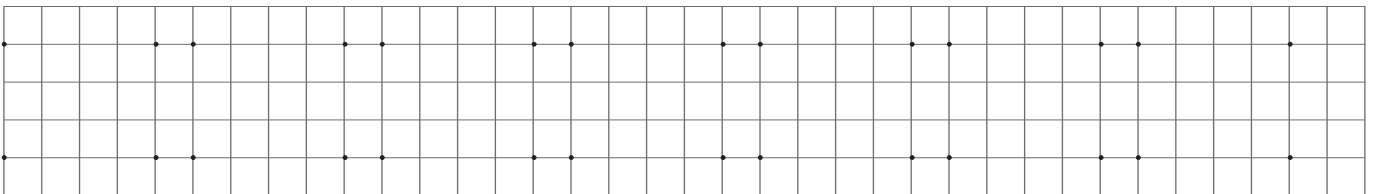
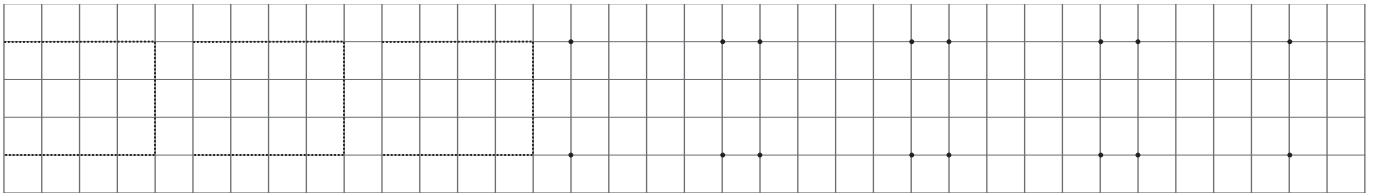
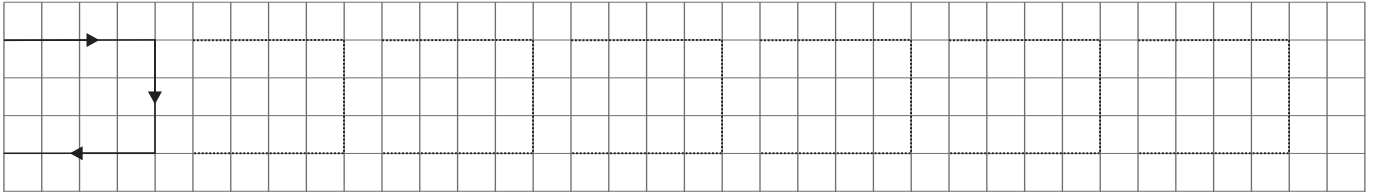

CRTANJE PO ZADANOM PREDLOŠKU

Prvo podebljaj iscrtkane linije, a zatim nastavi spajati točkice na isti način.
Pazi na smjer povlačenja olovke (bojice).

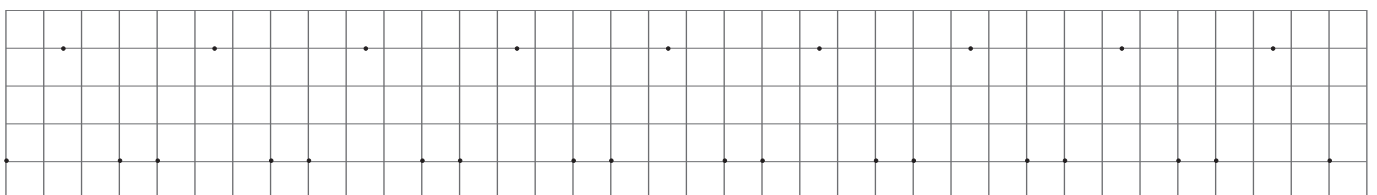
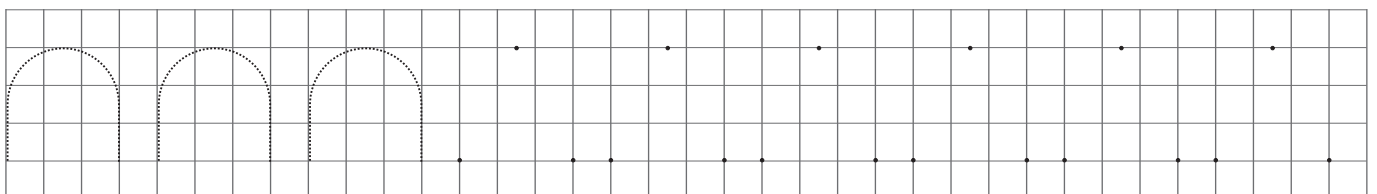
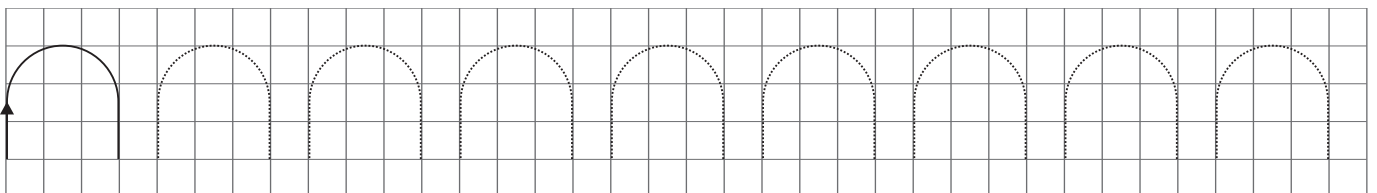
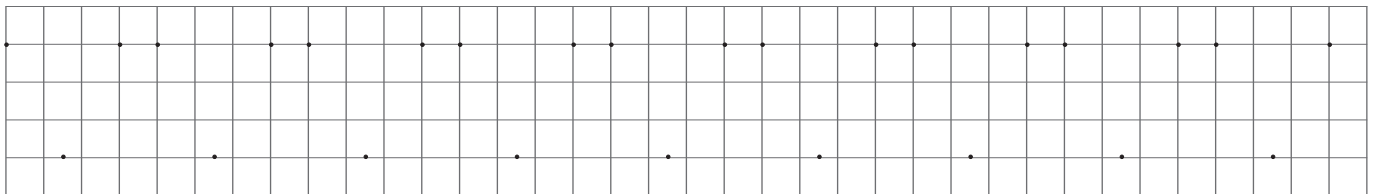
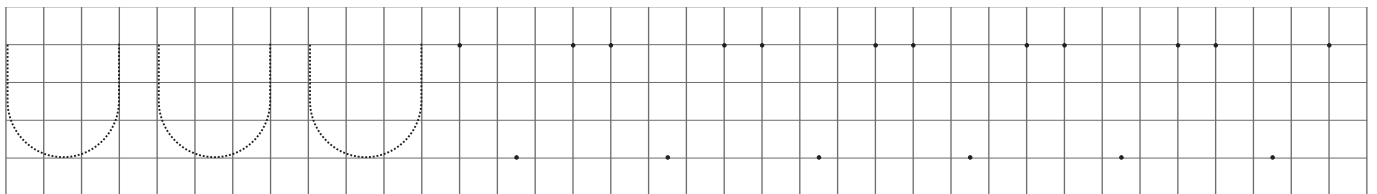
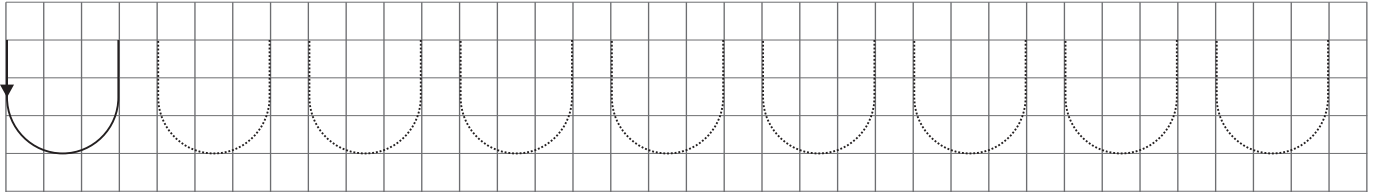

CRTANJE PO ZADANOM PREDLOŠKU

Prvo podebljaj iscrtkane linije, a zatim nastavi spajati točkice na isti način.
Pazi na smjer povlačenja olovke (bojice).

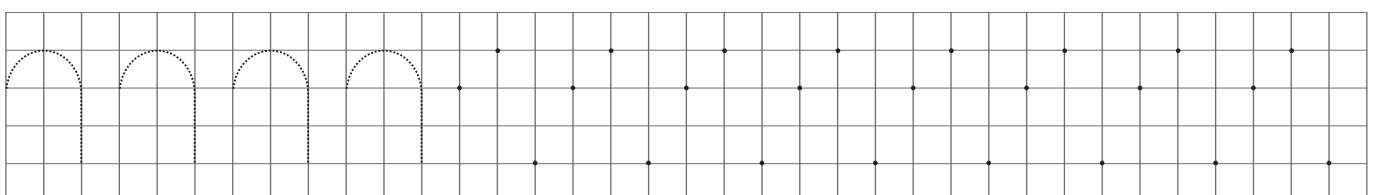
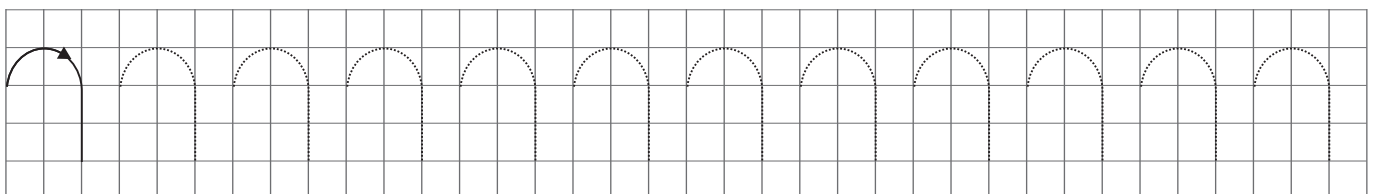
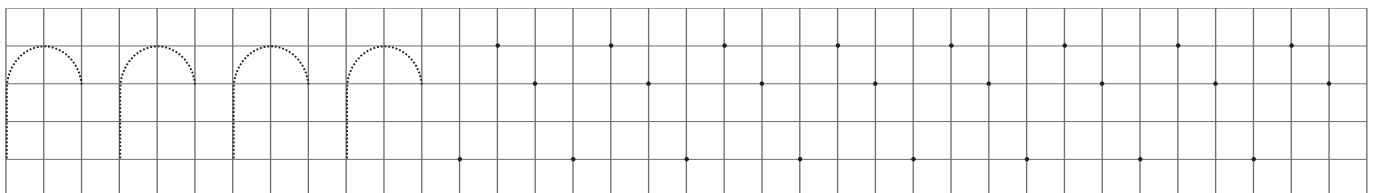
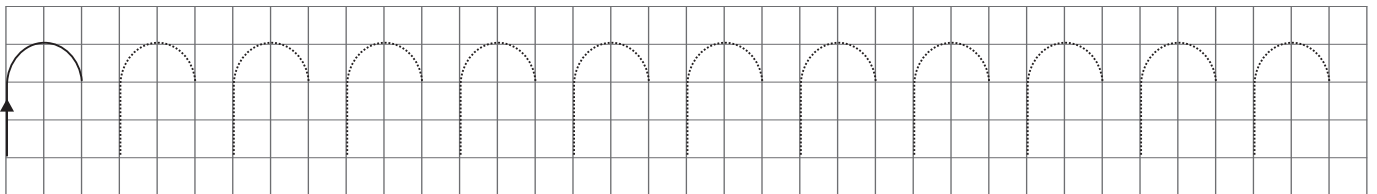
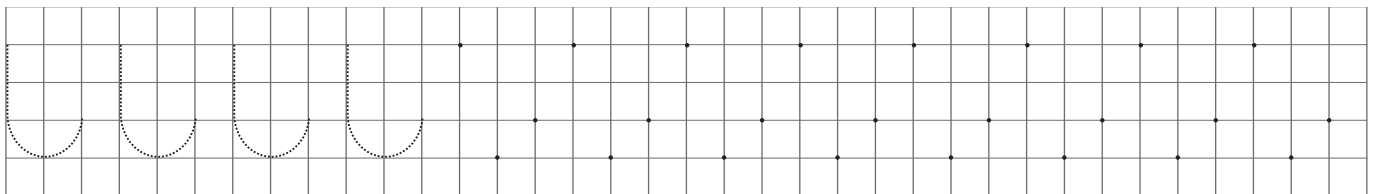
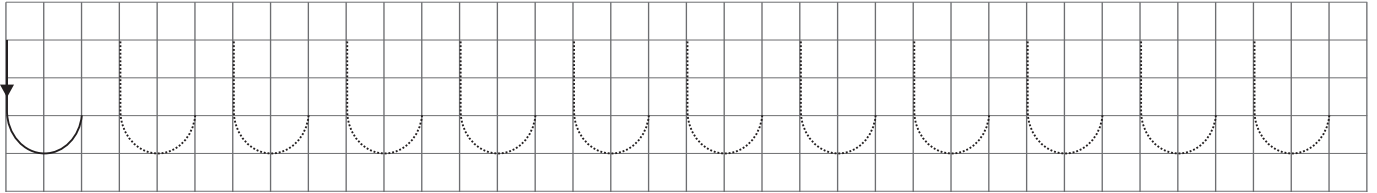

CRTANJE PO ZADANOM PREDLOŠKU

Precrtaj lik s lijeve na desnu stranu u istim bojama.

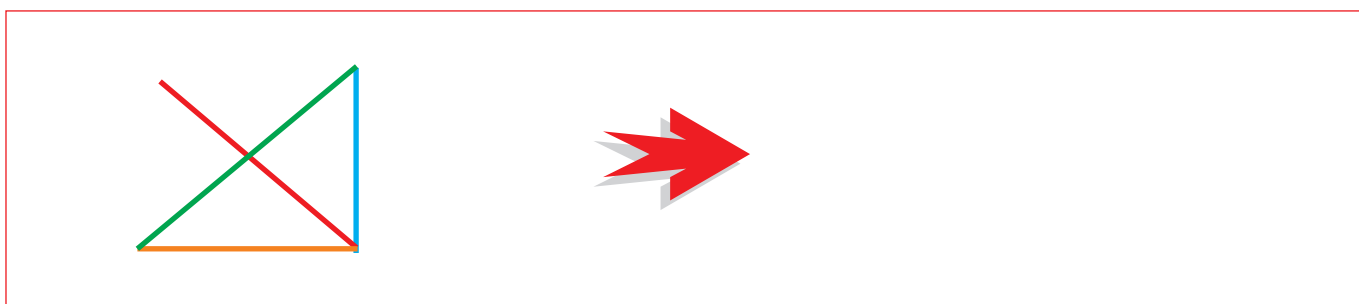
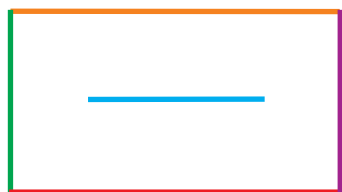
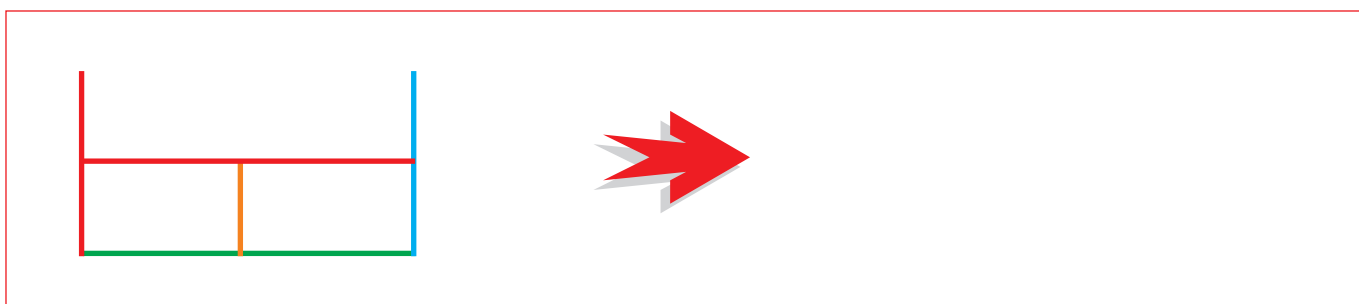
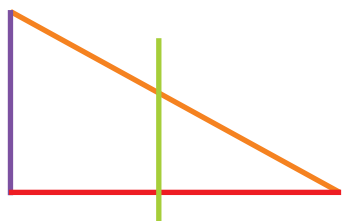
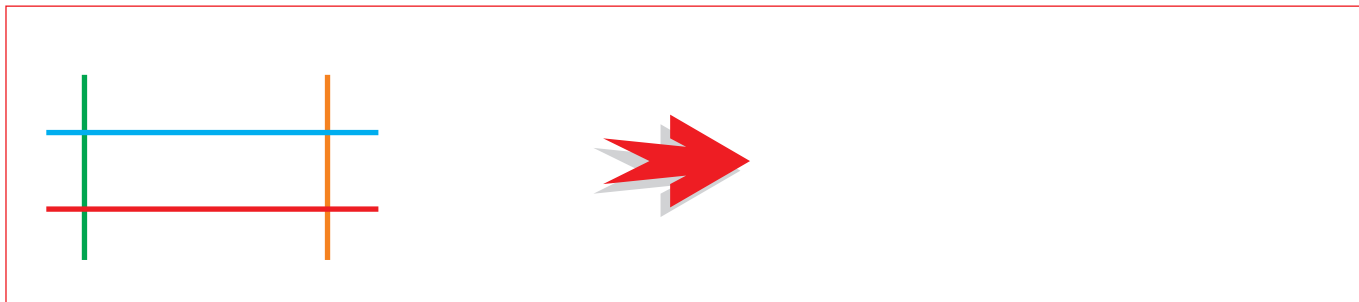

CRTANJE PO ZADANOM PREDLOŠKU

Precrtaj lik s lijeve na desnu stranu u istim bojama.

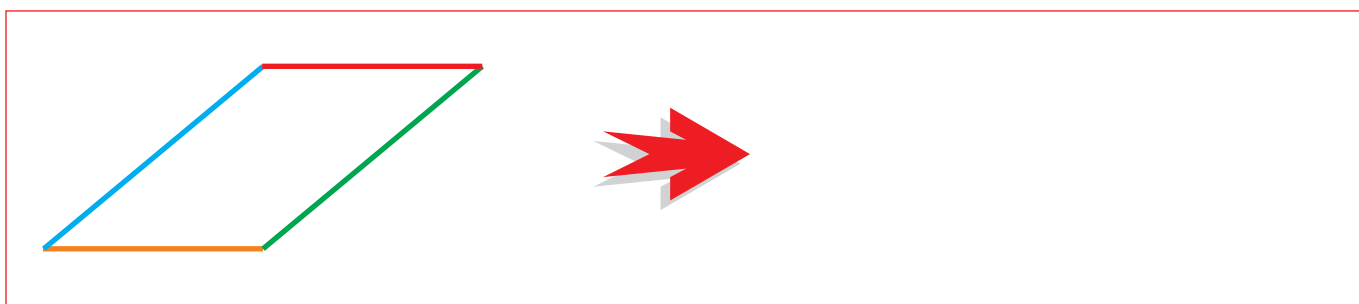
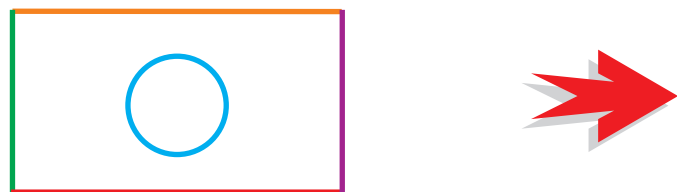
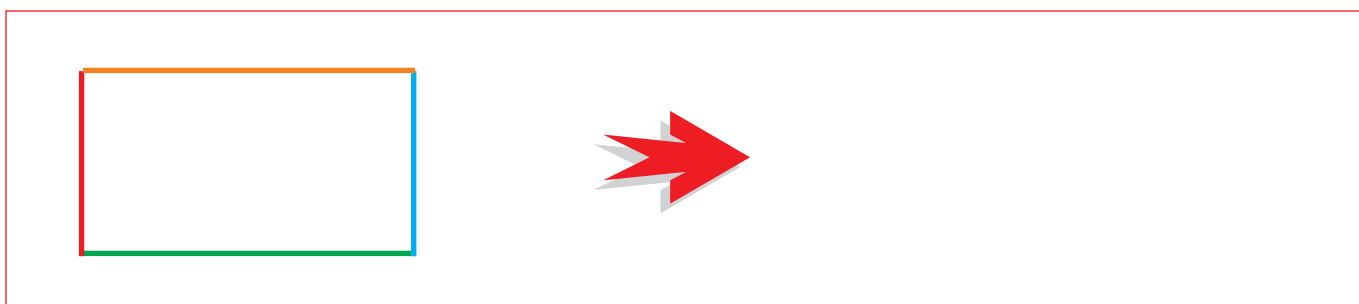
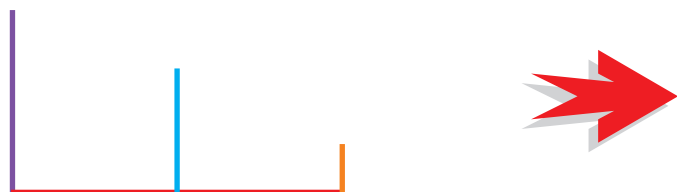
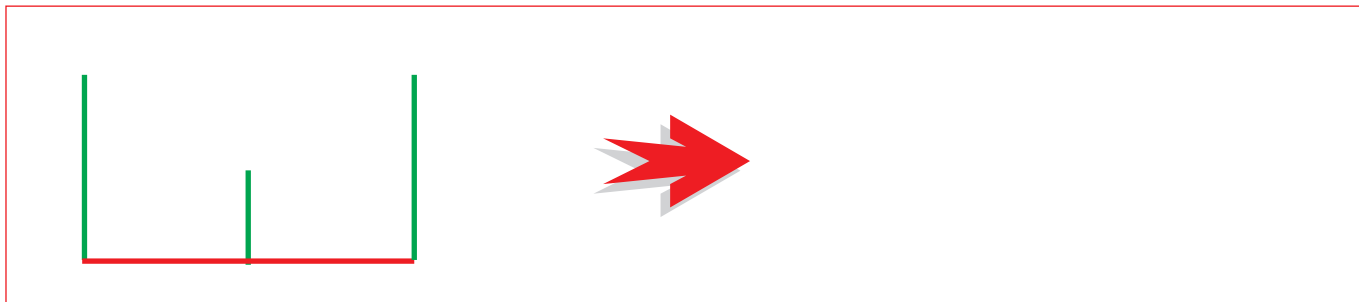

CRTANJE PO ZADANOM PREDLOŠKU

Precrtaj lik s lijeve na desnu stranu u istim bojama.

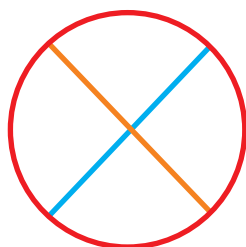
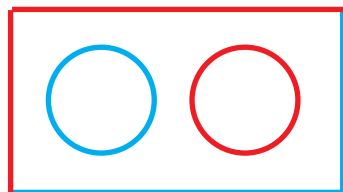
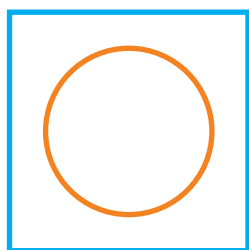

Početne vježbe pisanja

