

.....

؛ ؛ ؛ ؛

- - - - -

||||

+ + +

////

\\ \\ \\

\\\\ \\

x x x

.....

.....

.....

.....

o o o

oo oo

o o o

x x x

x x x

oxo oxo

~ ~ ~

~ ~ ~

~ ~ ~

~ ~ ~

m m m

w w w

□ □ □

ε ε ε ε

⚡ ⚡ ⚡ ⚡

/// ///

/// ///

/// ///

////

////

////

////

////

////

c c c

o o o

u u u

v v v

x x x

y y y

o o o o o

C C C

o o o

X X

o o

o o o

l l

O o O o

O o O o

l l l

l l l

s s s s

E E E E

z z z z

z z z z

l l l l

y y y y

b b b b

o o

o o o

r r r r

~ ~ ~

f f f

~ ~ ~

7 7 7

h h h

7 7 7

7 7 7

o o o

o o o

666

666

666

666

6666

999

999

999

000

666

666

666

666

666

666

666

666

666

LLL

LLL

LLL

LLL

LLL

LLL

LLL

LLL

LLL

LLL

LLL

LLL

LLL

LLL

LLL

LLL

LLL

LLL

m m

mmm

777

n m

mmm

lll

lll

sss

lll

cl cl

ll ll

ll ll

cl cl

cl cl

ll ll

ll ll

ll ll ll

ll ll ll

ly ly

ll ll

ll ll

ly ly

cl cl

cy cy

ll ll ll

ll ll

ll ll

ll ll

ll ll

ll ll

ll ll

ll ll ll

ll ll ll

ll ll

ll ll ll

ll ll ll

WwW

mmmm

MMM

AhAh

AhAh

uuuu

UUUU

telete

MhMh

MhMh

eeee

llll

lelele

leleel

ssss

sejes

shsh

seljel

eeee

lll

llll

llll

cccc

mm

lll

llll

llll



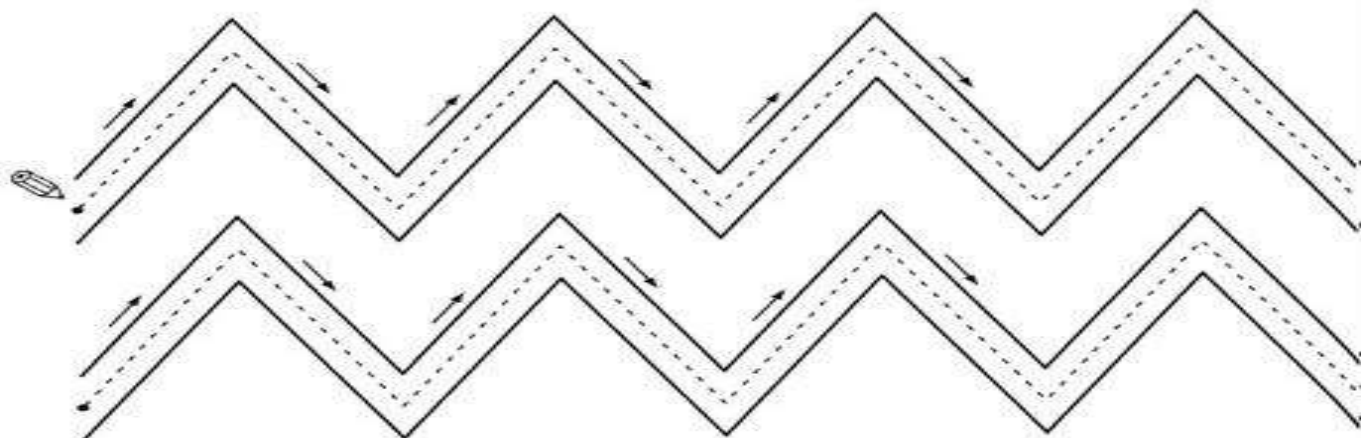
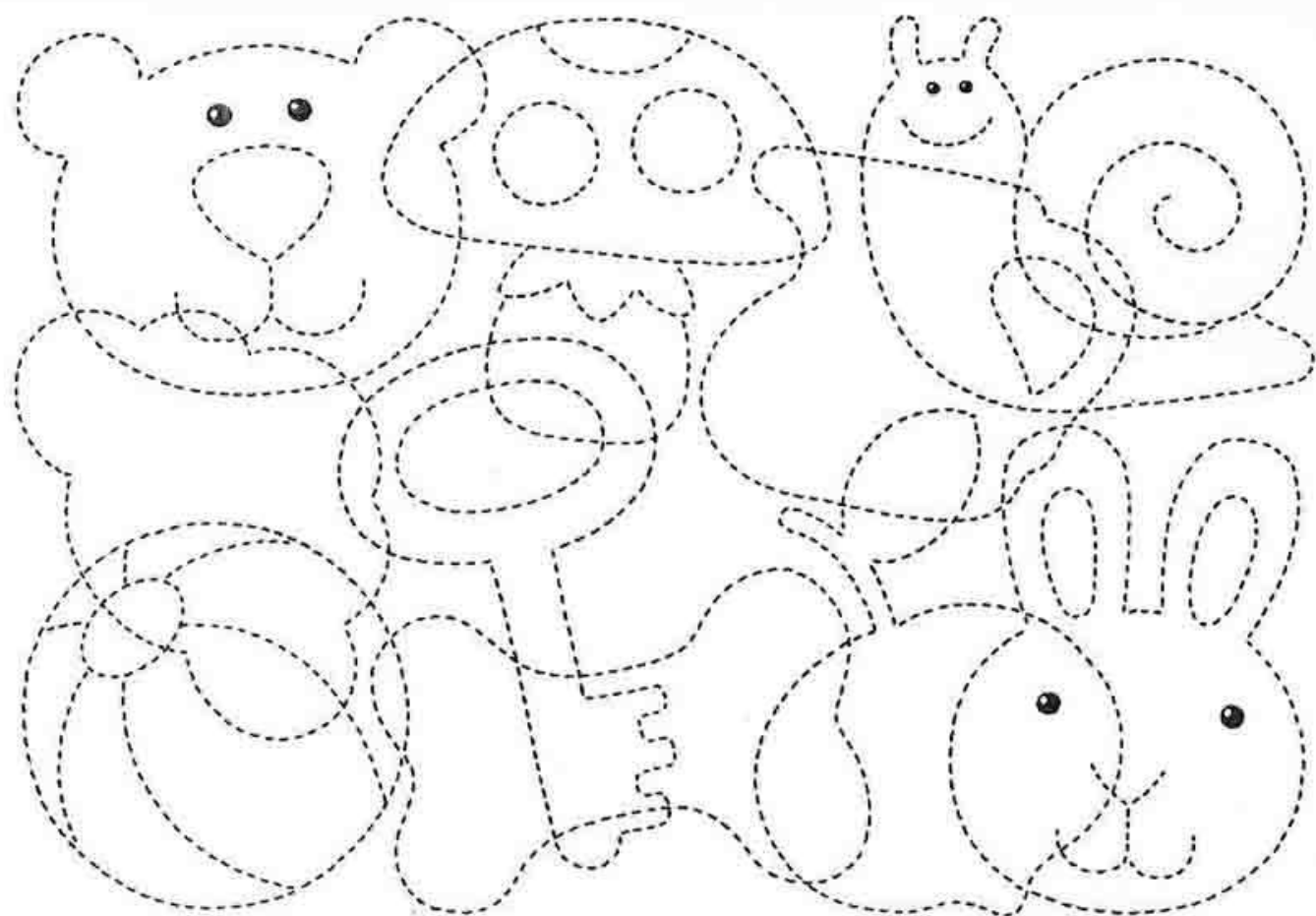

x Repasar los cucuruchos de los helados y colorearlos. Realizar las grafías.

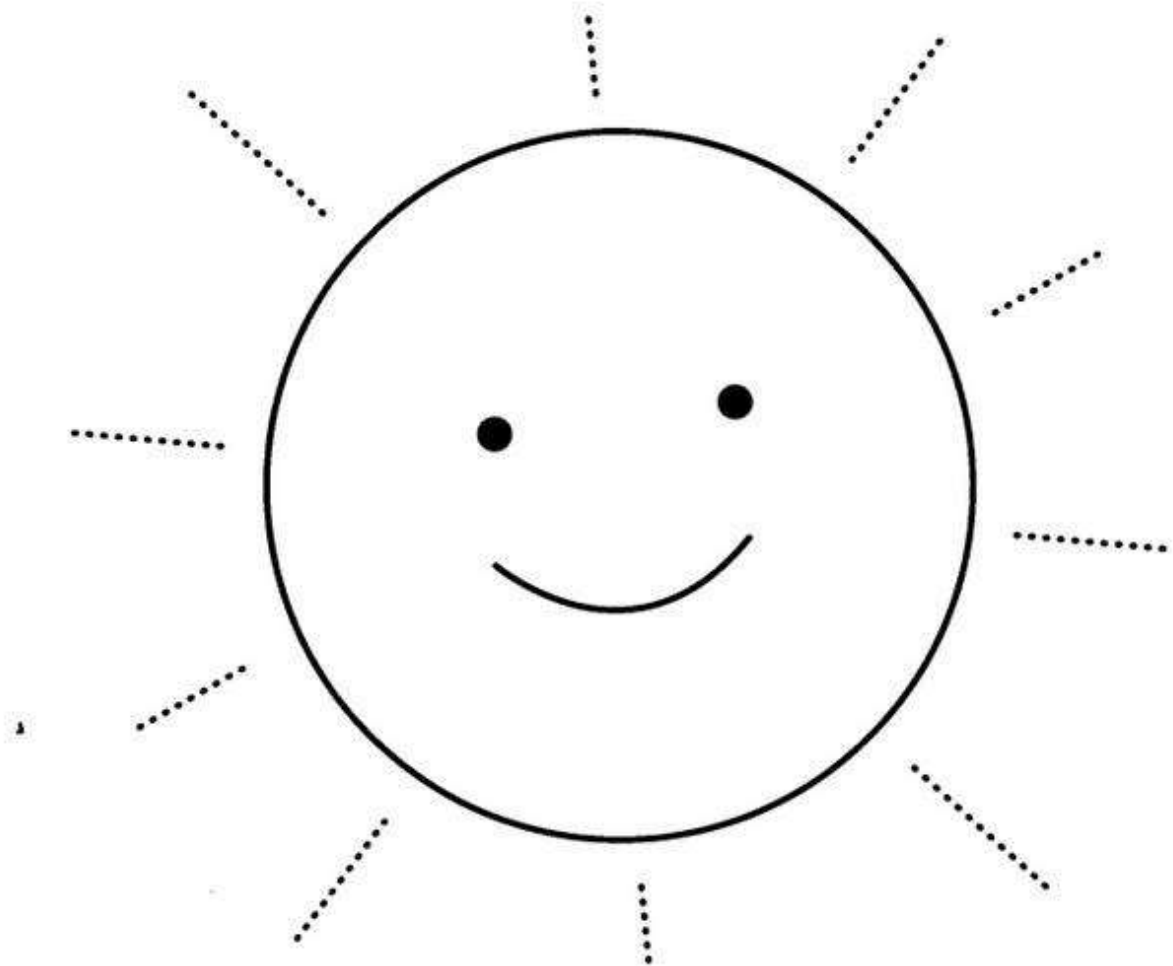

Picar los rayos del sol y pintarlo de amarillo.

• *Reseguir* los trazos con la yema del dedo respetando las flechas.  
• Realizar las grafías con rotulador de punta gruesa.

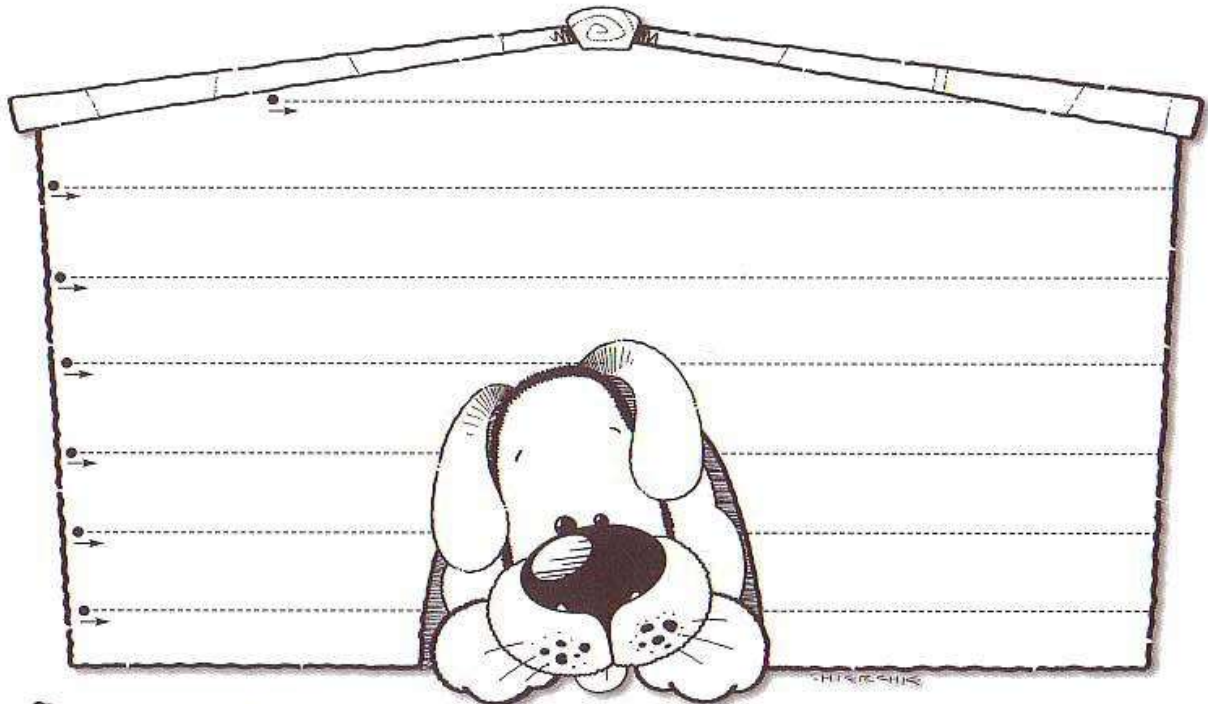

*Un consejo:* El niño o la niña puede colorear de un color suave "el fondo de la casita" (la fachada) una vez que repase los trazos, para que perciba las dos partes: trazo sobre fondo.

UNO, DOS, TRES INDIECITOS...  
• COMPLETA LOS PUNCHOS.



• TERMINA DE DIBUJAR ESTOS PÉCES.

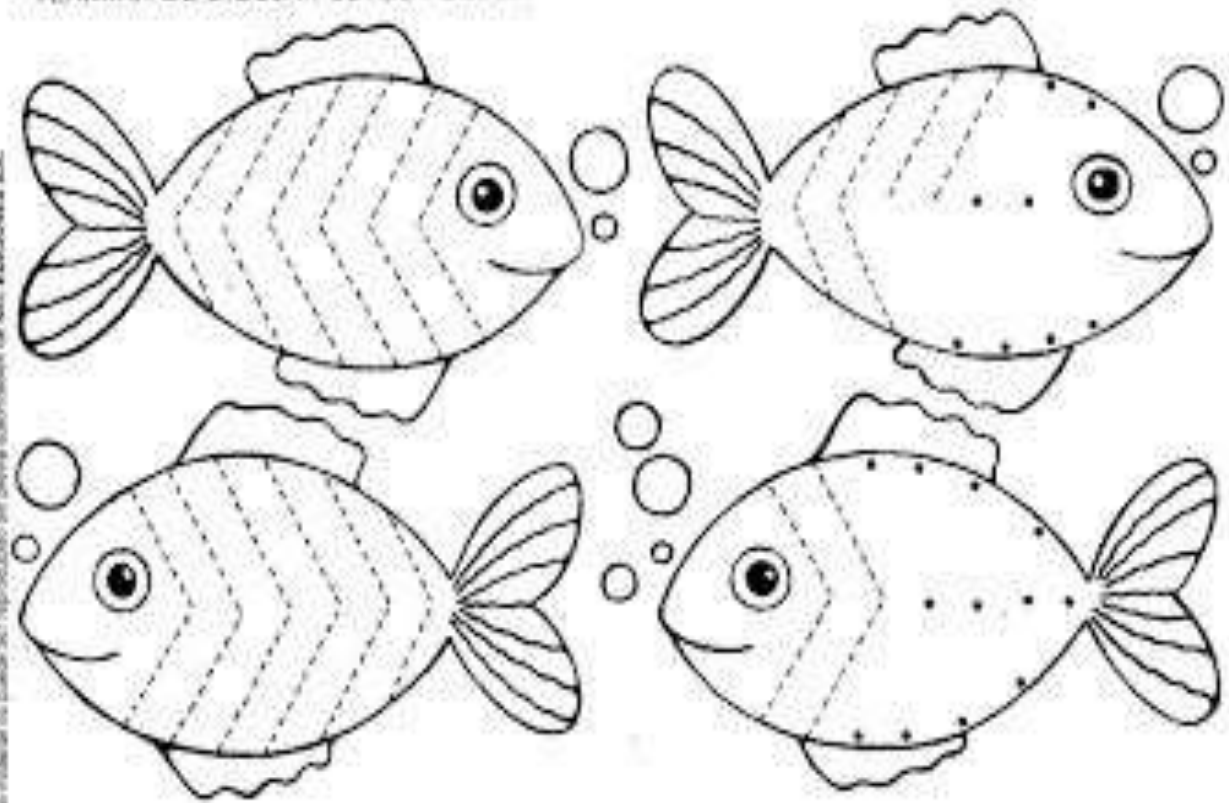

• AYUDA A DON MONO A DIBUJAR TRIÁNGULOS DE DIFERENTES COLORES Y TAMAÑOS.

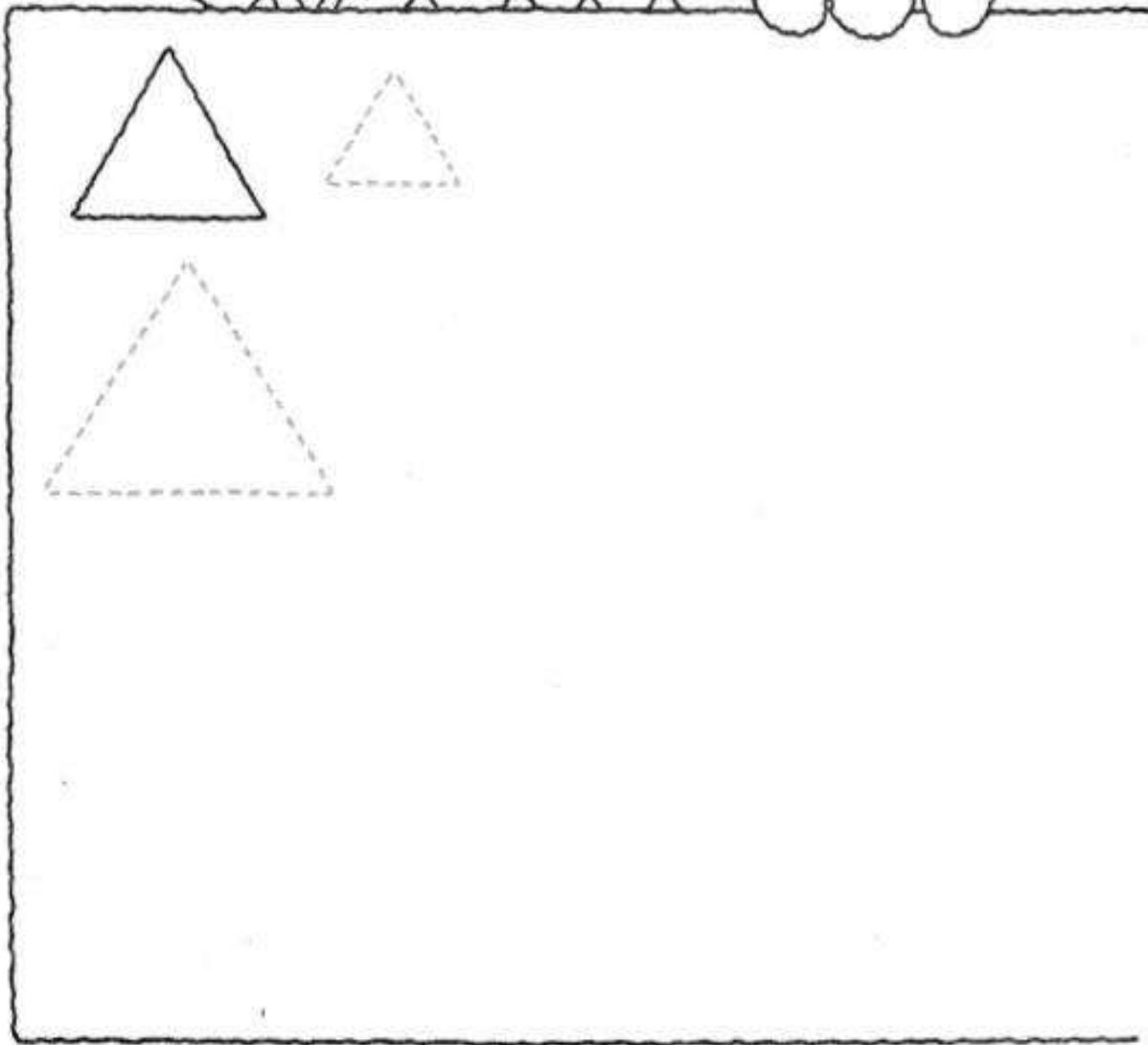
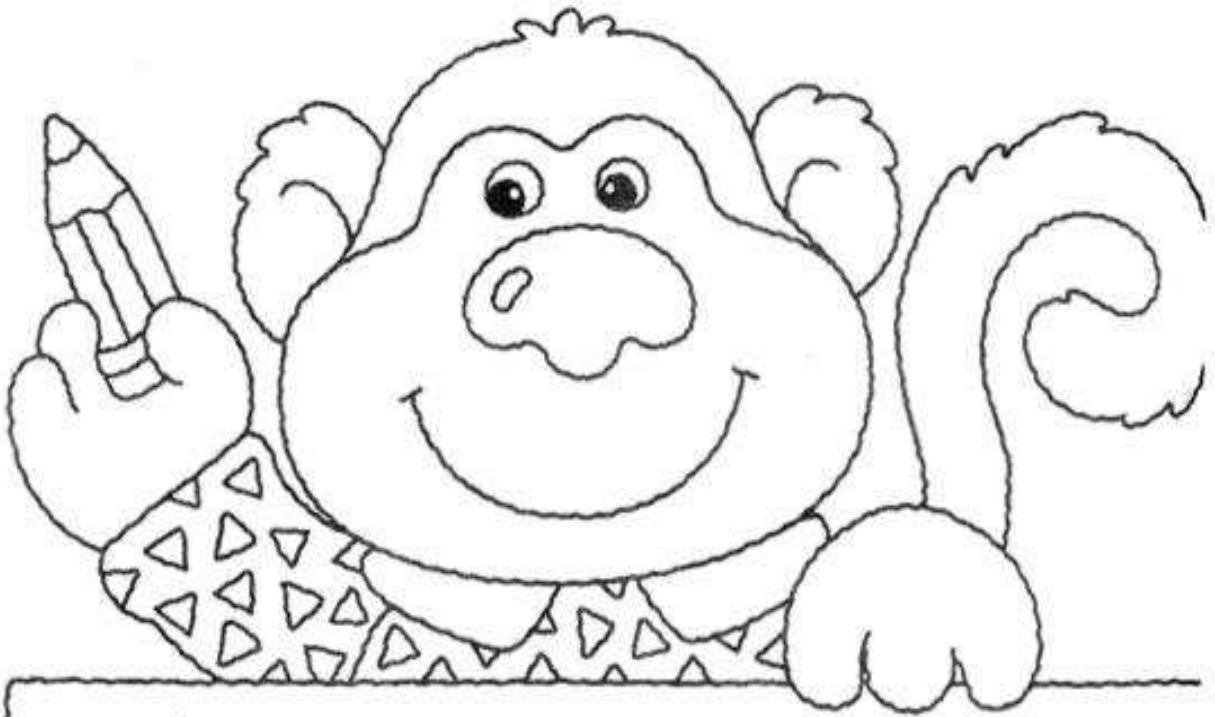

**CORTINAS PARA MAMÁ**

- COMPLETA CON LÁPIZ EL DISEÑO DE LAS TELAS.
- ¿CUÁL ELEGIRÍAS? COLOREALA.



© 2004 by Grafimania, S.A. Todos los derechos reservados. No se permite la explotación económica ni la transformación de esta obra. Queda permitida la impresión en su totalidad.

GRAFIMANIA

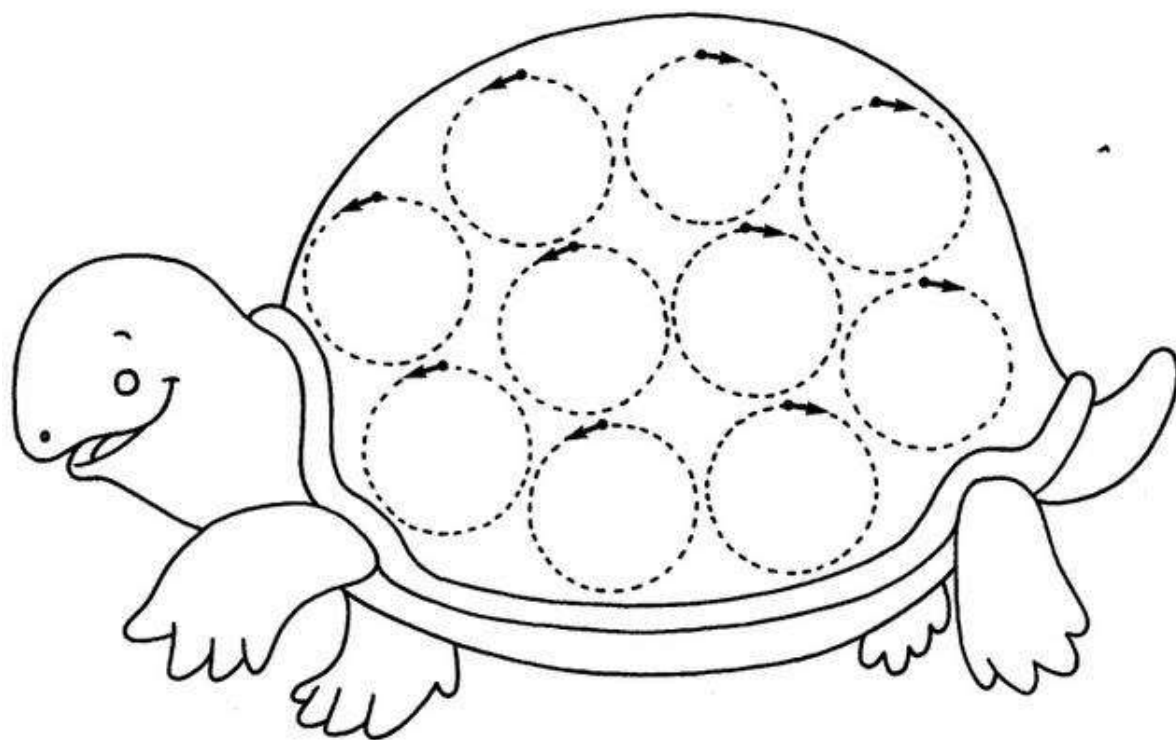

- DIBUJA EL CAMINO QUE DEBE RECORRER CADA PERRO PARA ENCONTRAR EL HUESO QUE ENTERRÓ EN EL JARDÍN.
- COLOREA EL PERRO QUE RECORRE EL CAMINO MÁS LARGO.

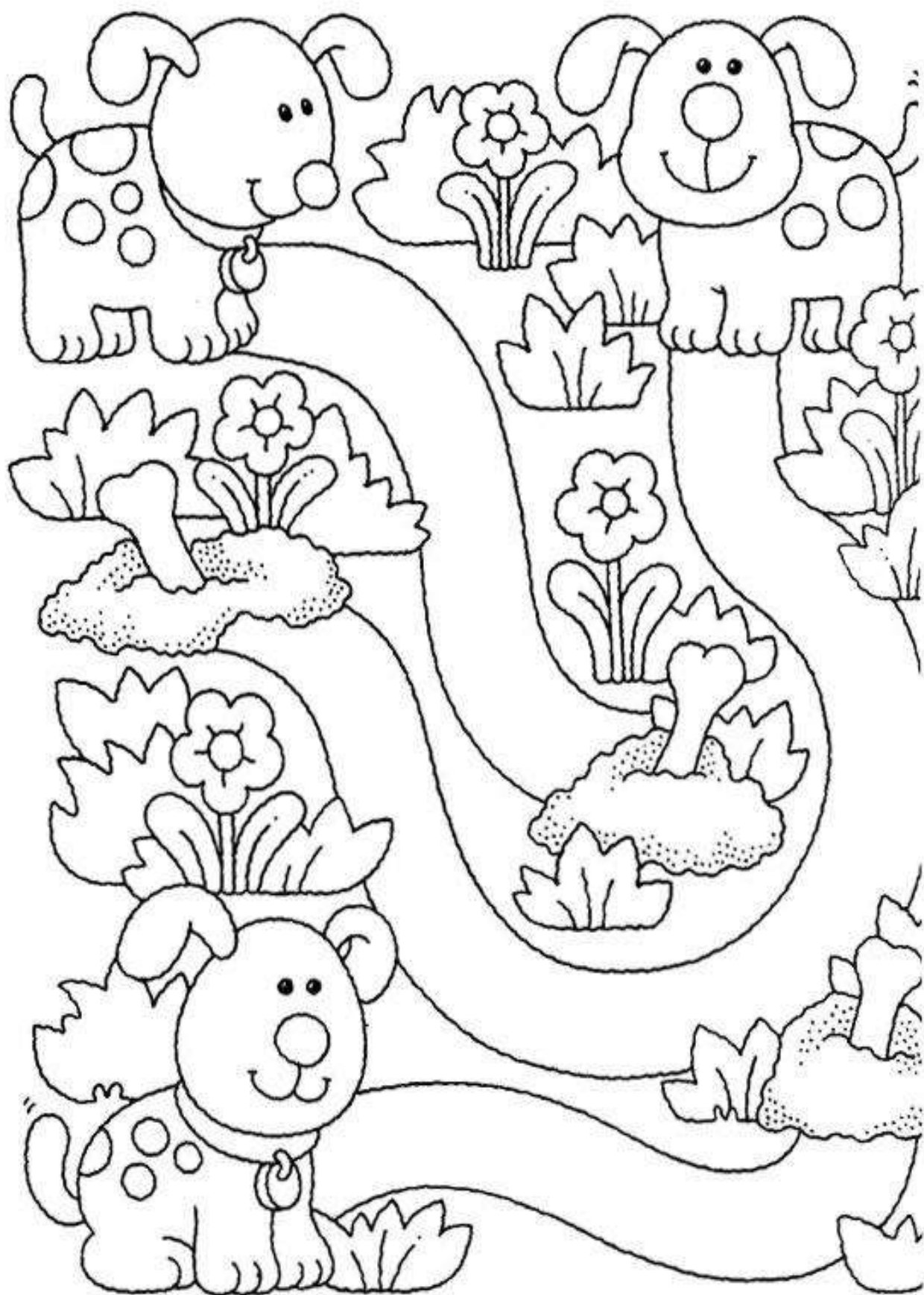

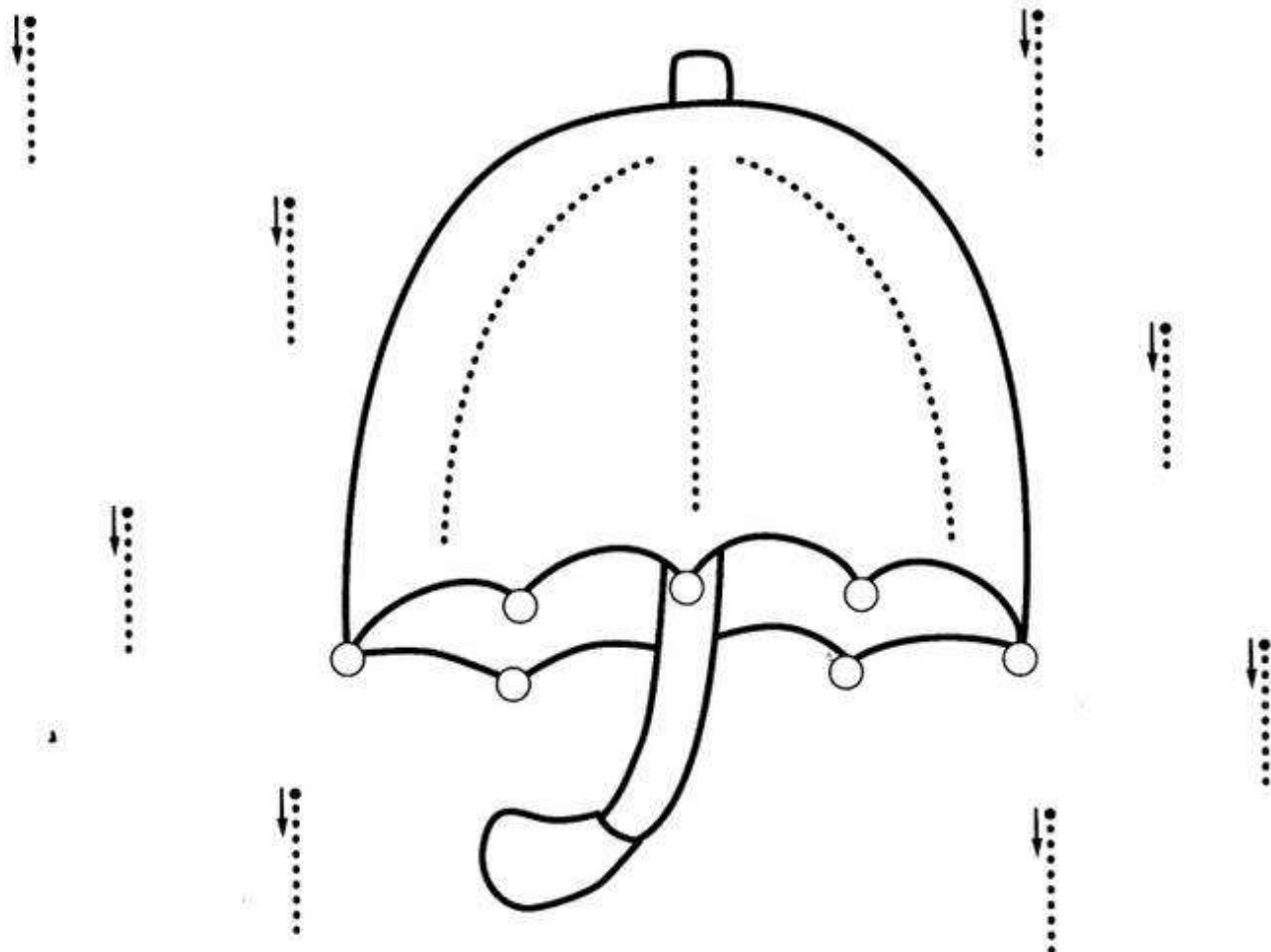

Picar en los puntos marcados en el paraguas. Repasar los trazos de la lluvia.

• USANDO RAYAS Y RAYITAS INVENTA PEINADOS PARA CADA RETRATO.

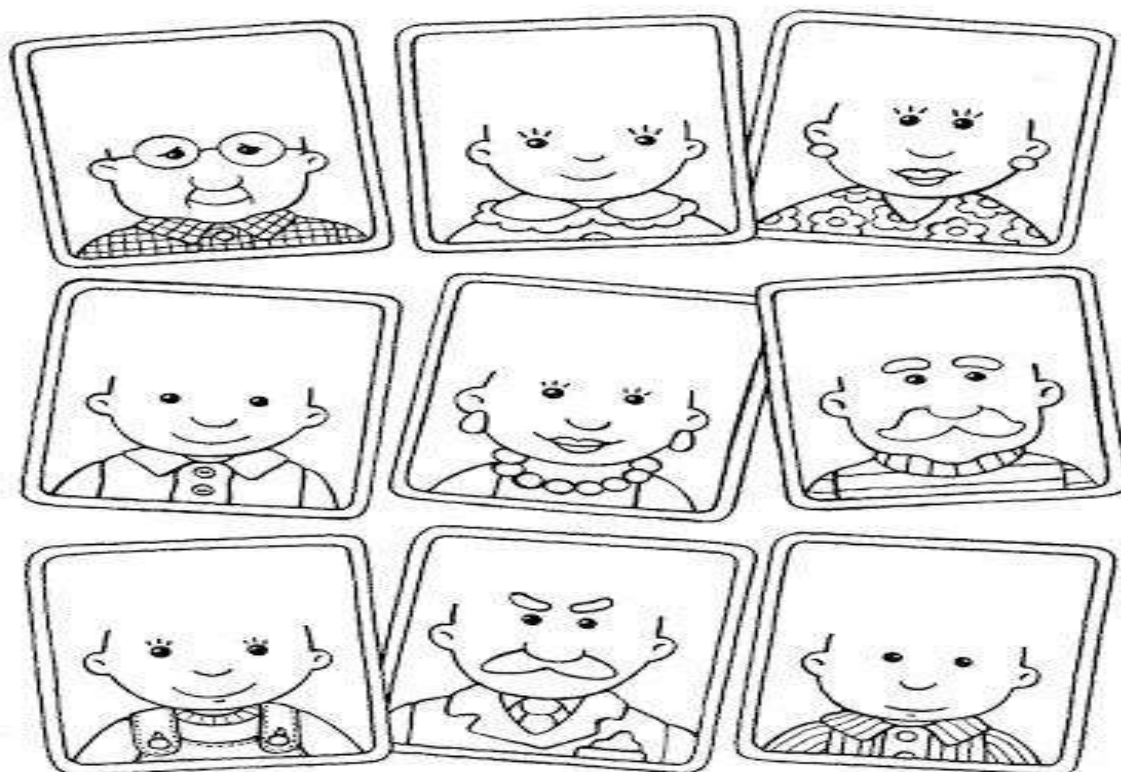

En todos los países de España se publica por autorización de KEL DOUGLAS S.A.

**¡QUÉ RICA TORTA PREPARÓ EL COCINERO!**

- DIBÚJALE MUCHOS CONFITES A ESTA TORTA, SIGUIENDO LA DIRECCIÓN INDICADA.
- LUEGO DIBUJA TANTAS VELAS COMO QUIERAS.

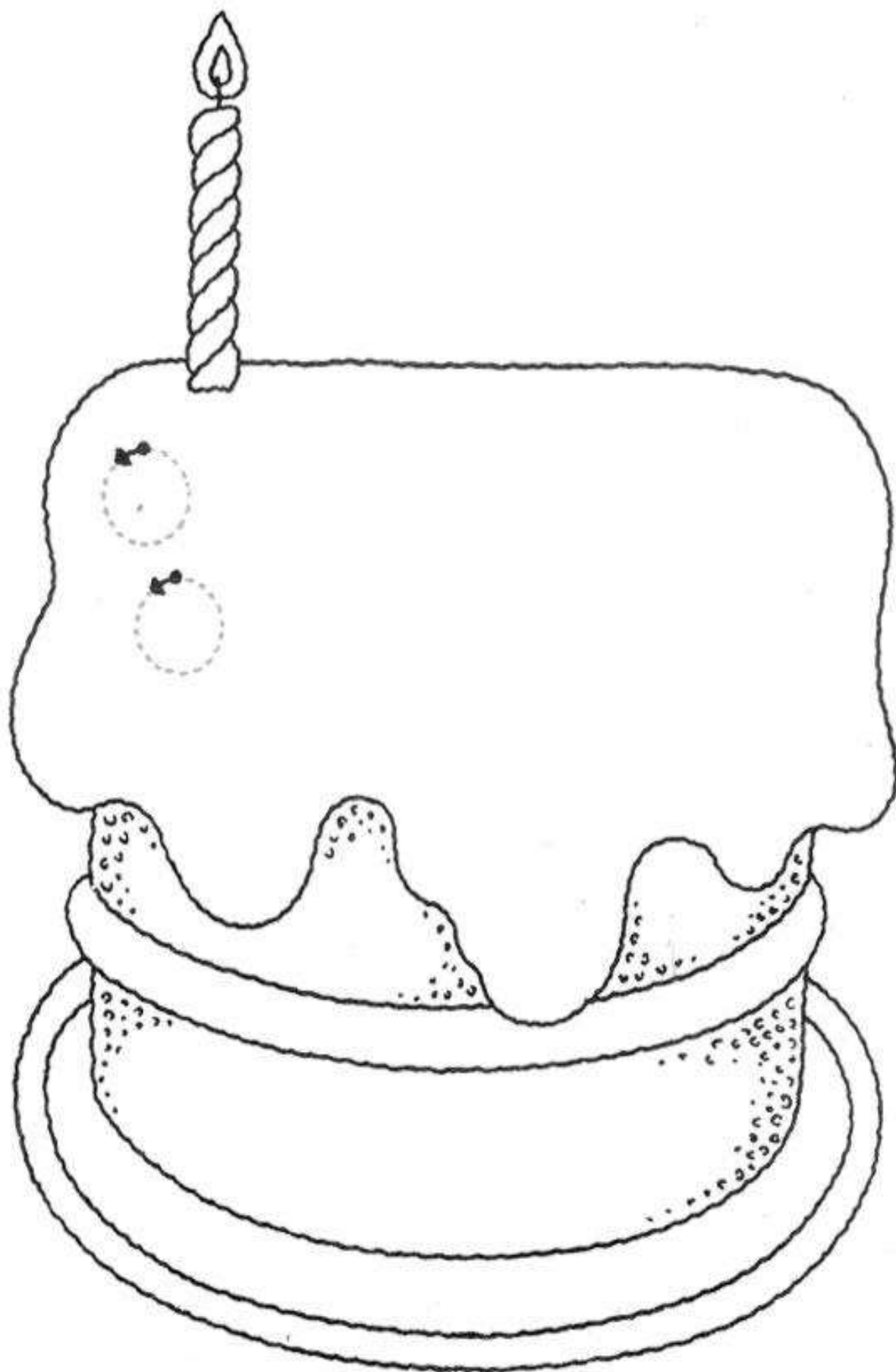



¿QUE NUMERO SE PARECE A LAS MONTAÑAS? REPASAR LOS TRAZOS Y COLOREAR.

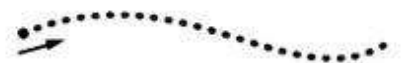
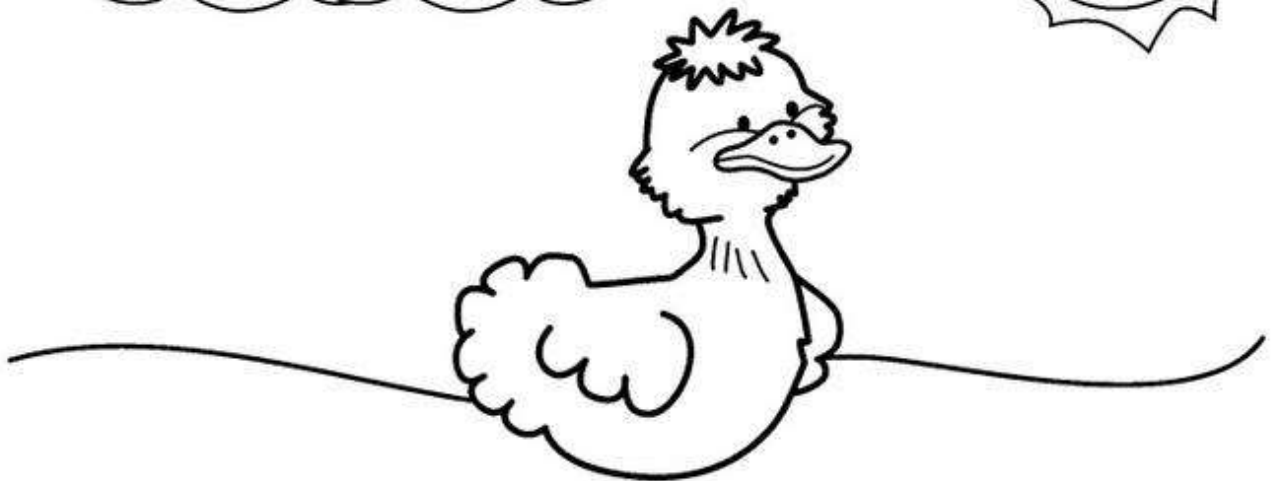
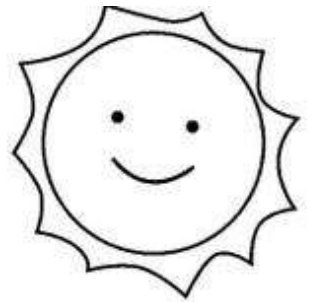
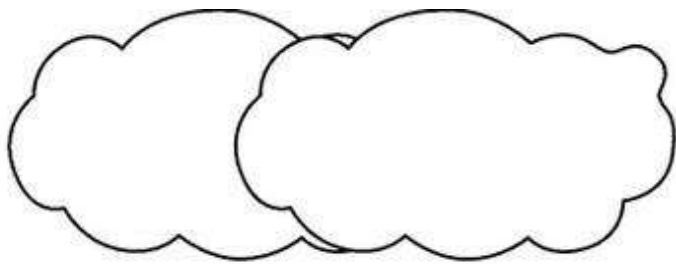
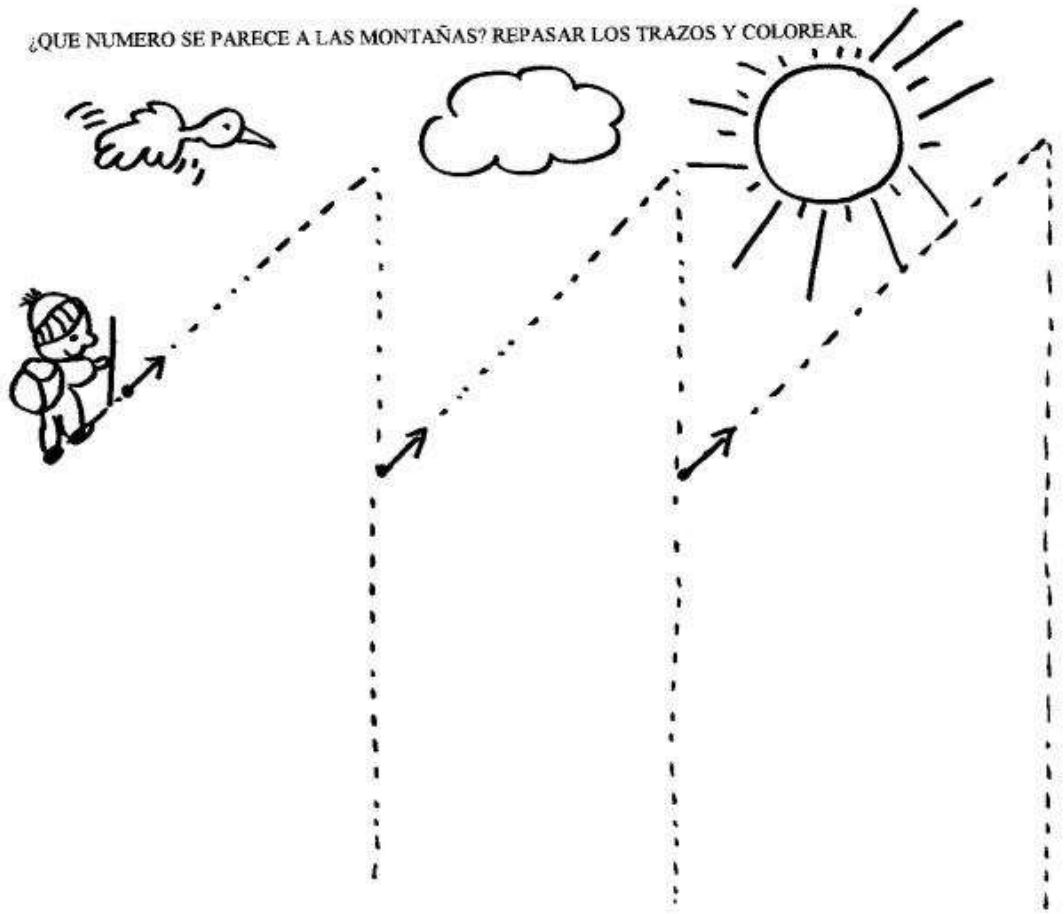

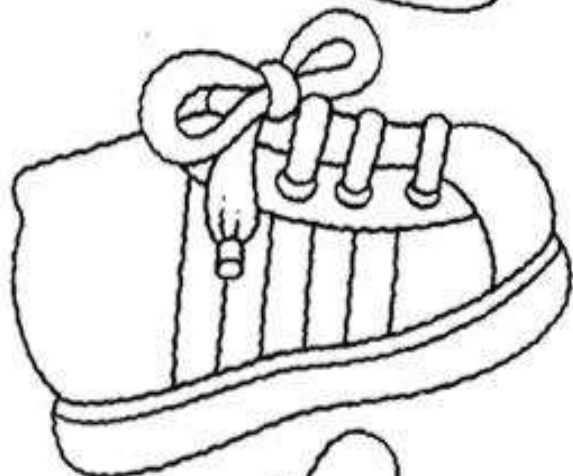

Repasar las líneas y colorear lo que está arriba.

• COLOREA DE LA MISMA MANERA Y LUEGO UNE CON UNA LÍNEA LOS PARES DE ZAPATOS.

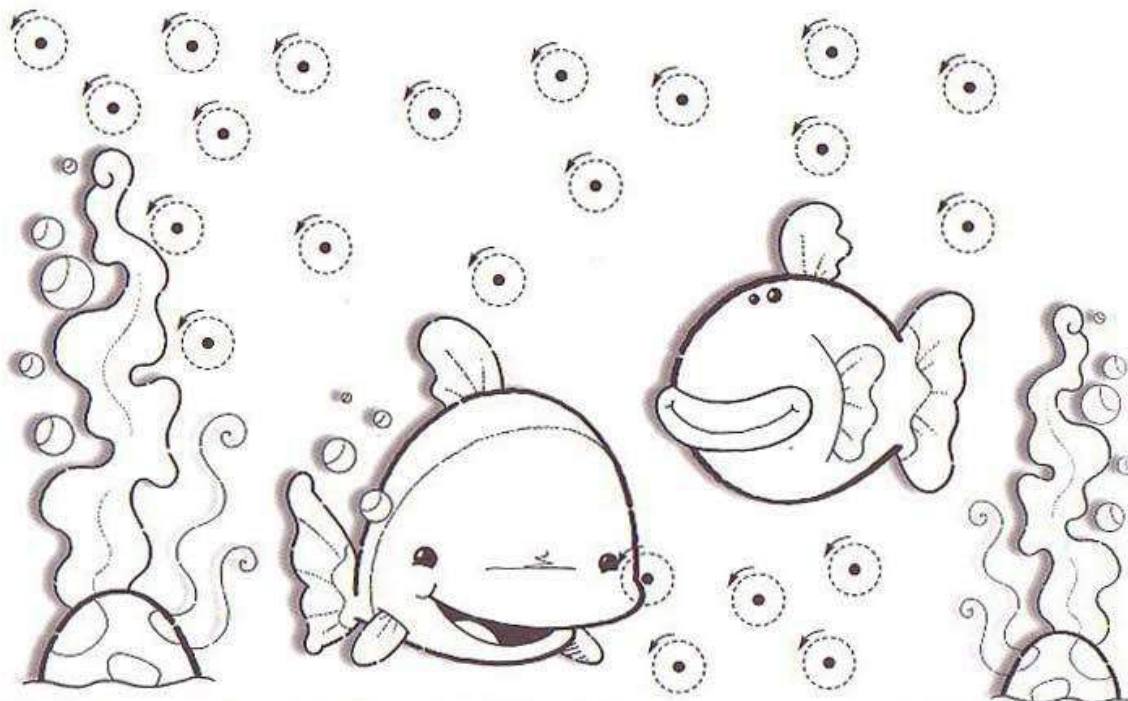

• **Iniciación** al punto. Reseguir los círculos.  
• Colorear alrededor del punto hasta rellenarlo.



 **Un consejo:** Una vez coloreadas las "burbujas" se pueden rellenar de bolitas de plastilina de distintos tamaños. El niño o la niña conseguirá mucha más precisión y destreza con los dedos.

24 GRAFOMOTRICIDAD 3 años

• **Repasar** las grafías con la yema de los dedos.  
• Reseguir siguiendo las indicaciones que marcan las flechas.



COLOREAR

 **Un consejo:** El niño o la niña puede colorear "el fondo del tejado" en color rojo suave una vez que repase los trazos, para que perciba las dos partes: trazo sobre fondo.

14 GRAFOMOTRICIDAD 3 años

- OSITO QUIERE CARAMELOS. LLENA EL FRASCO CON CONFITES DE TODOS COLORES.
- COLOREA CON TU CRAYÓN SU PELAJE MARRÓN.

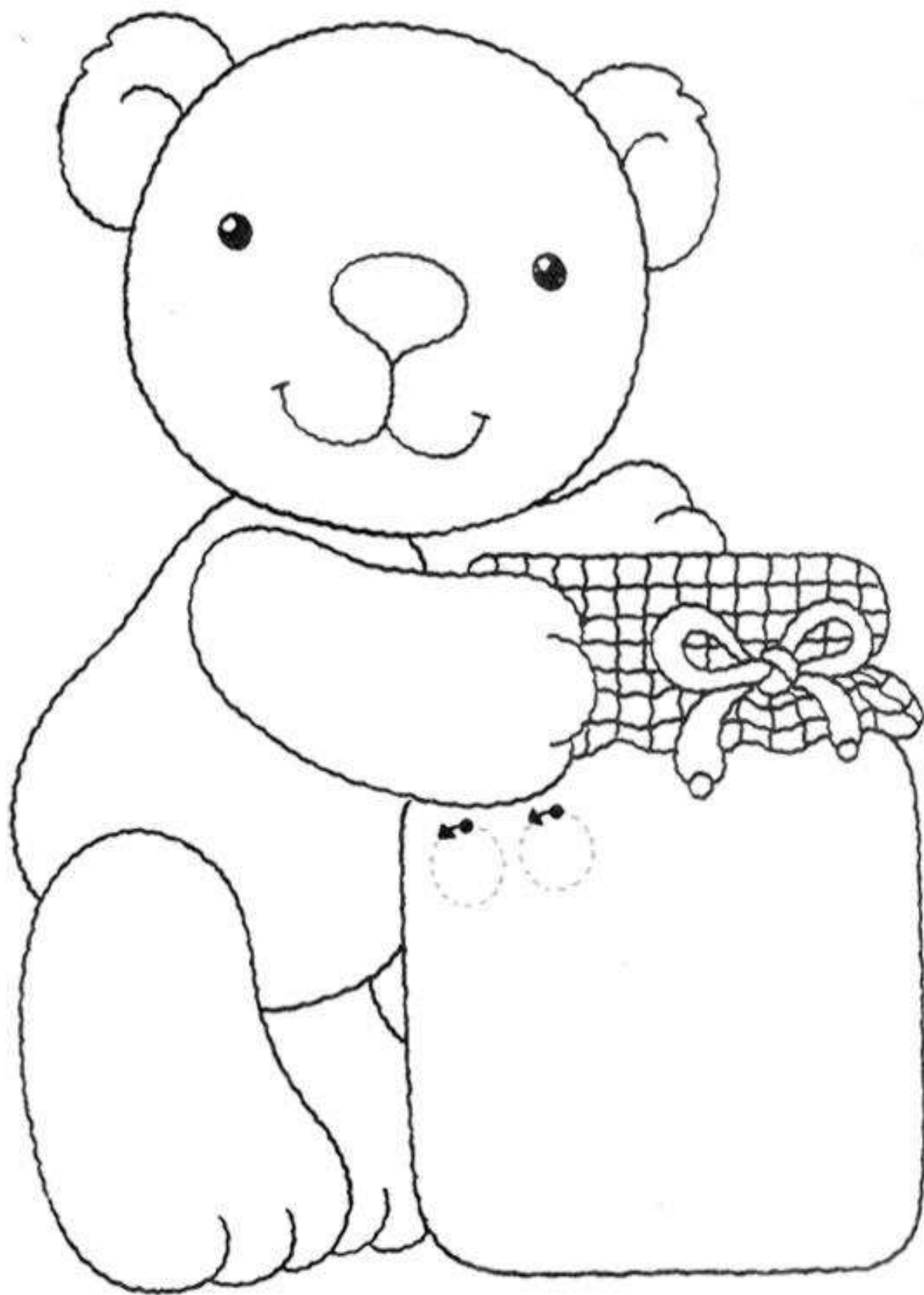

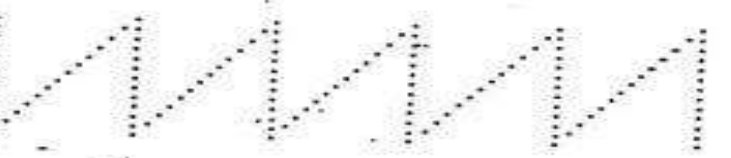
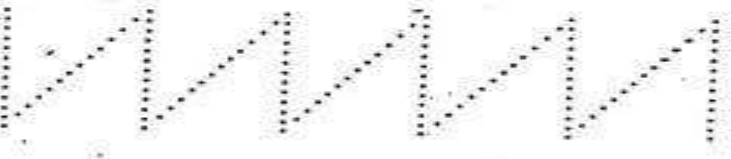
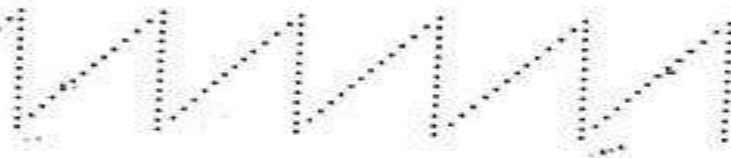
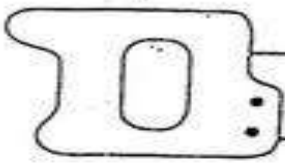

Repasa las líneas de puntos y colorea las figuras.

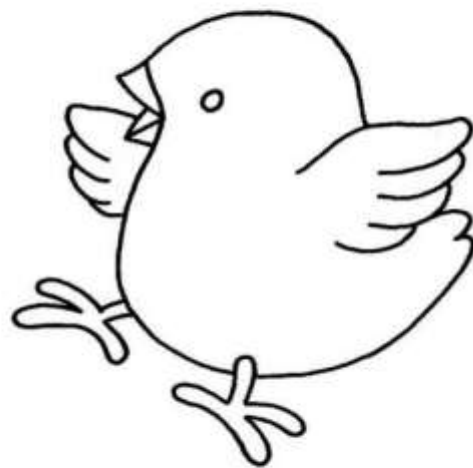

- DELINEA Y DECORA EL GORRO DE ESTE COCINERO GOLOSO COMO MÁS TE GUSTE.
- DELINEA Y COLOREA SUS ROJOS CACHETES.
- COMPLETA SU PAÑUELO CON LUNARES.



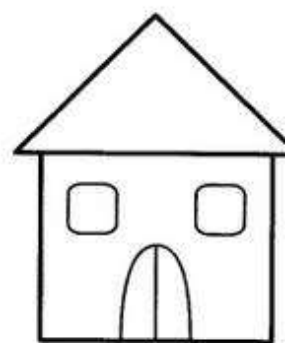
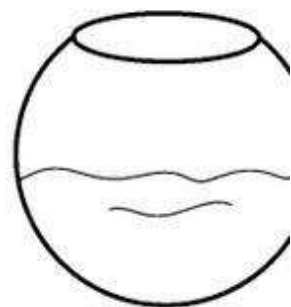
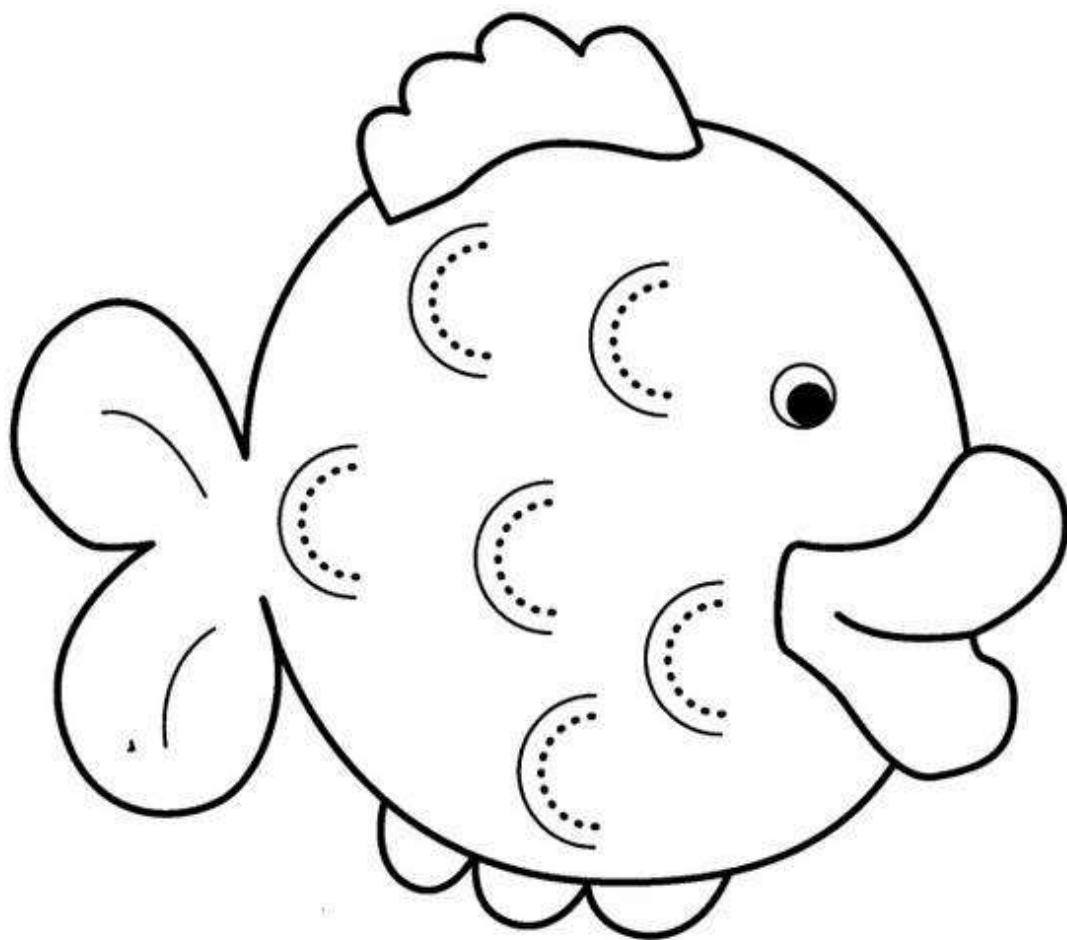

Repasar las líneas y unir el pez con su casa.

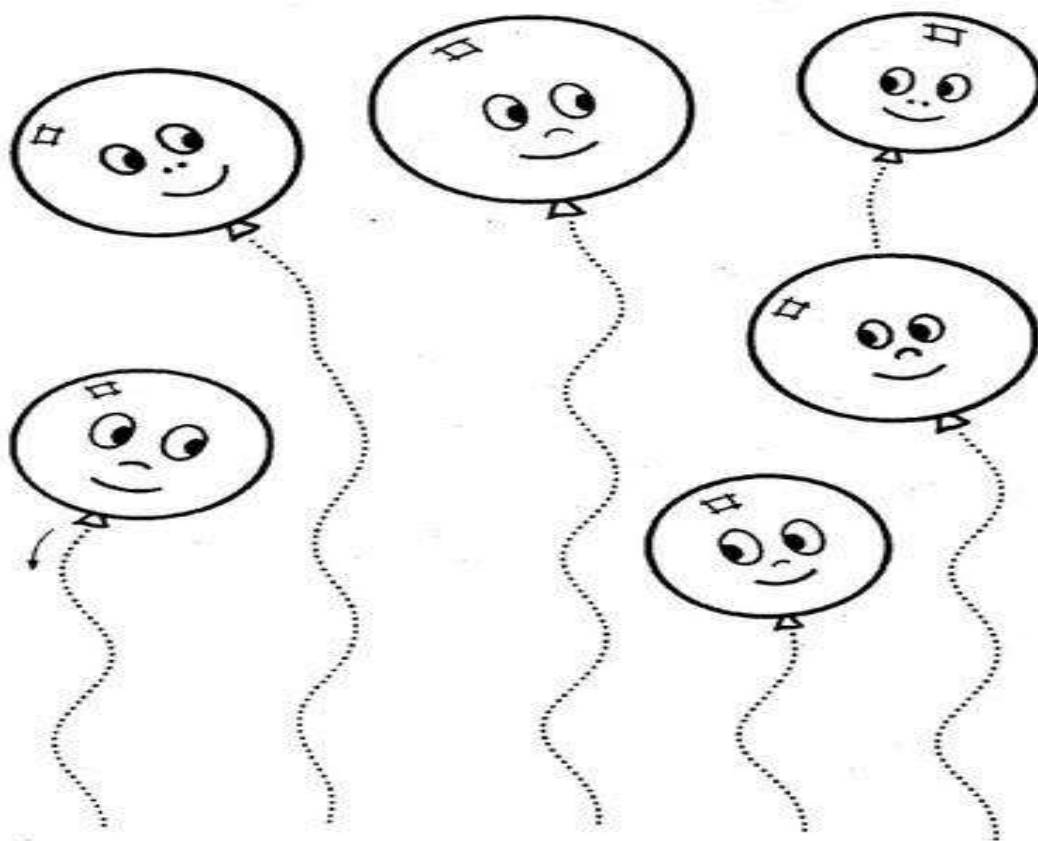

Sigue los puntos y colorea los globos.

### EL FLORERO DE MAMÁ

- DIBUJA CON CRAYÓN VERDE LOS TALLOS DE LAS FLORES. ¿TE ANIMAS A DIBUJARLES HOJITAS?
- DECORA EL FLORERO CON RAYAS DE COLORES.
- COLOREA LAS FLORES COMO MÁS TE GUSTE.

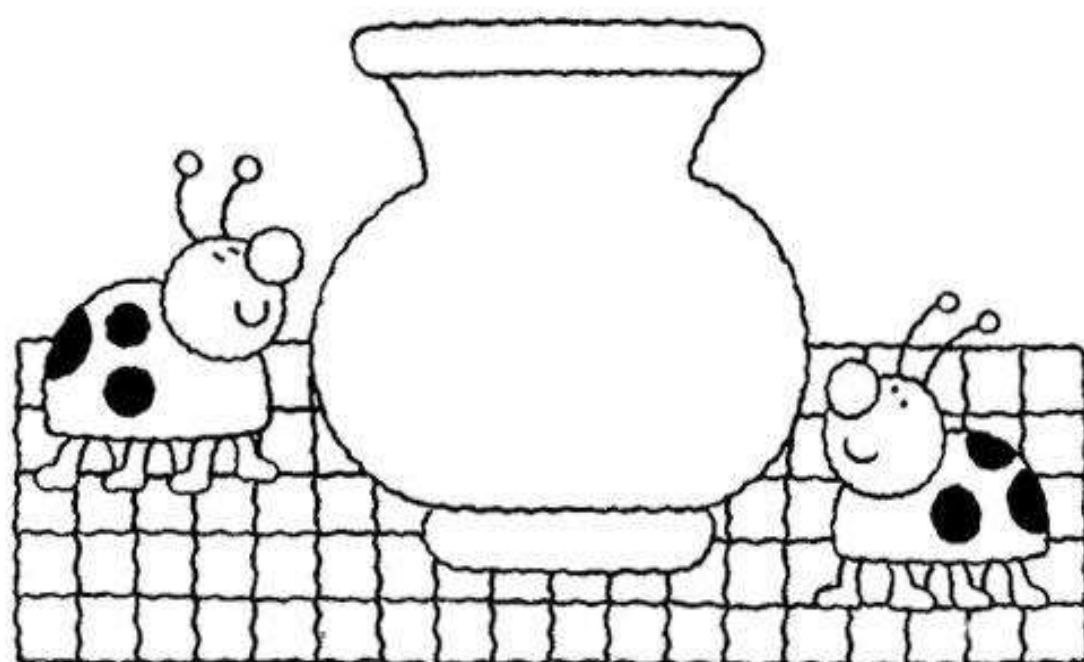
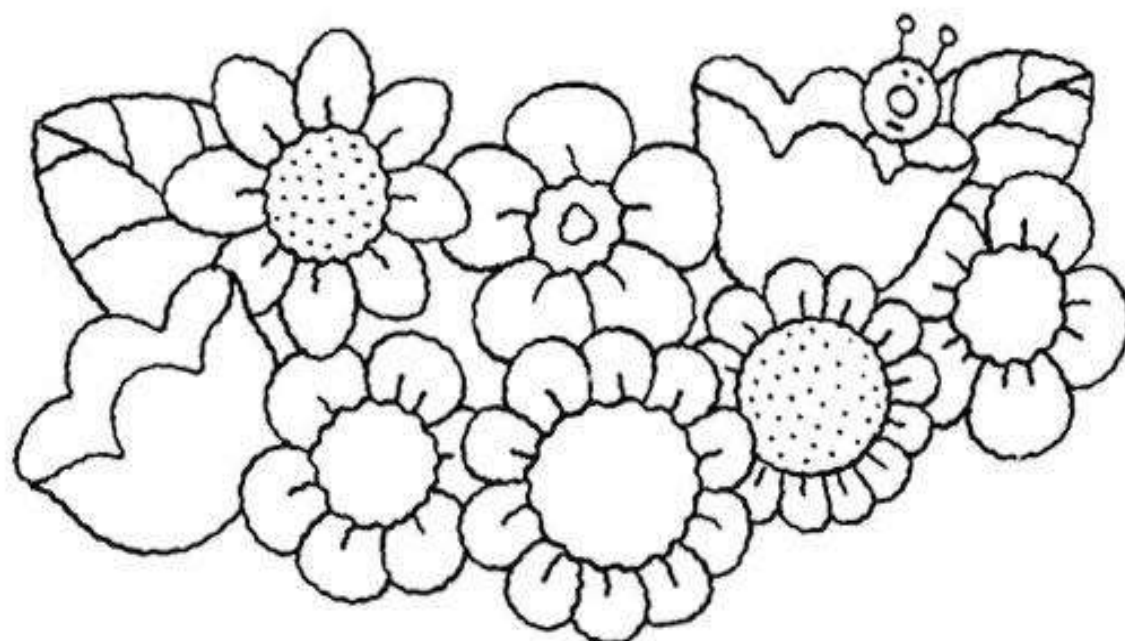



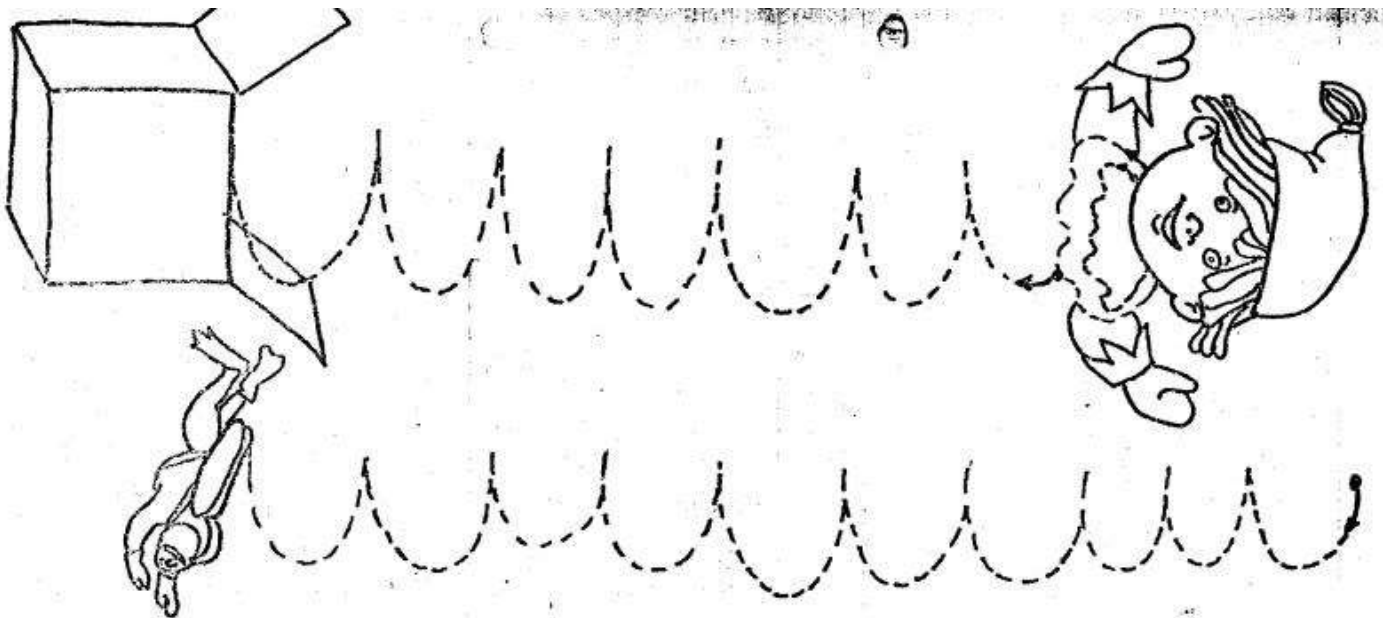
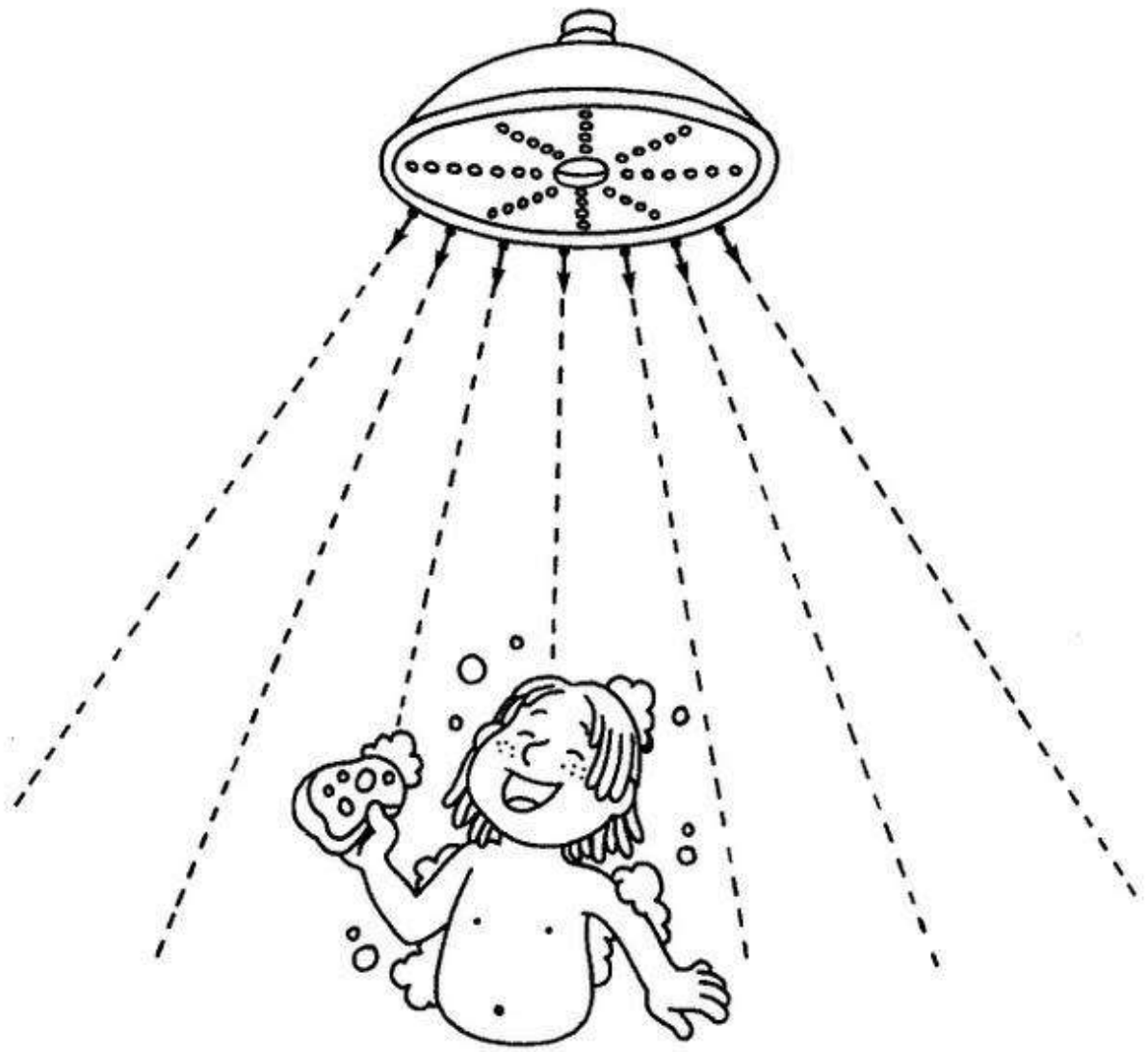

### UN PAYASO MALABARISTA

- DECORA EL TRAJE DEL PAYASO CON LUNARES DE COLORES.
- DELINEA LOS CÍRCULOS.



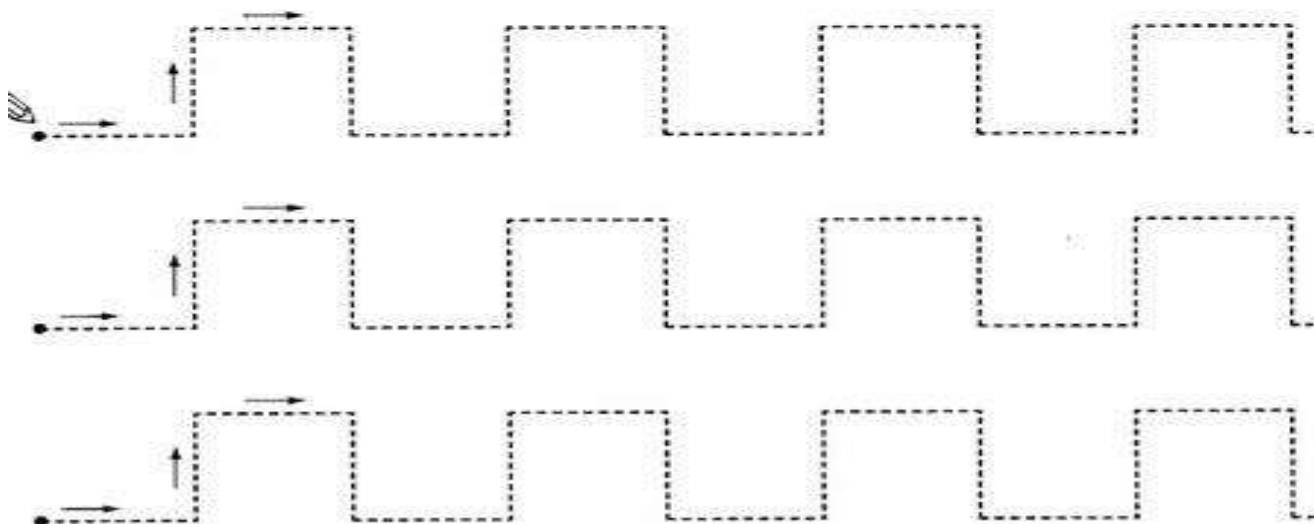
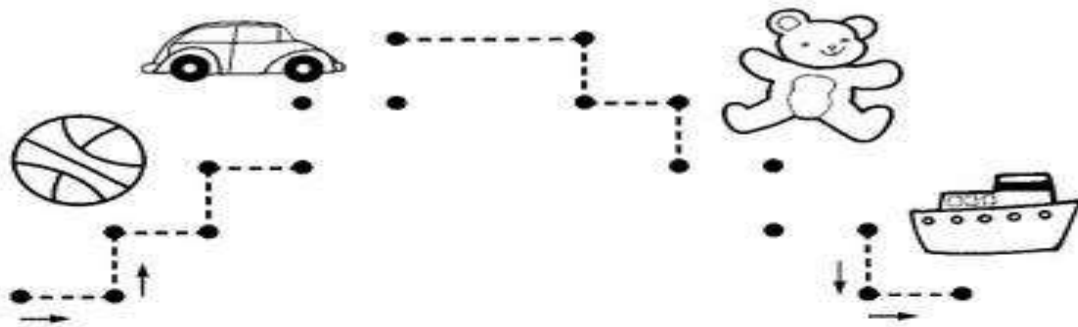

**x Unir los puntos para hacer los peldaños de la escalera y subir los juguetes. Realizar las grafías.**

- COMPLETA CADA DIBUJO CON PELOS O ESPINAS.
- ¿CUAL TE PARECE QUE PINCHA MÁS? COLOREALO.

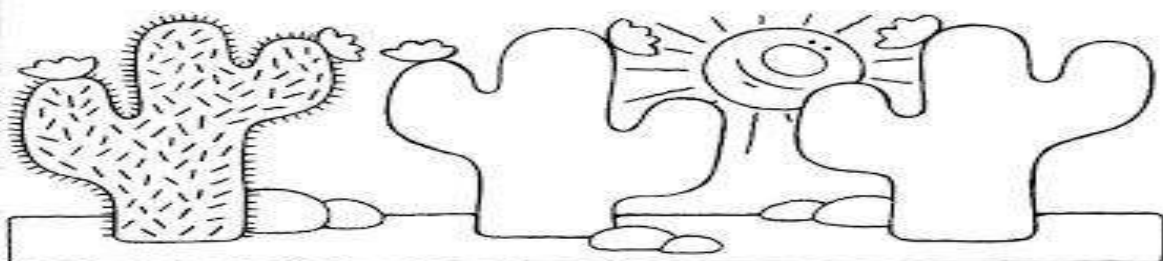
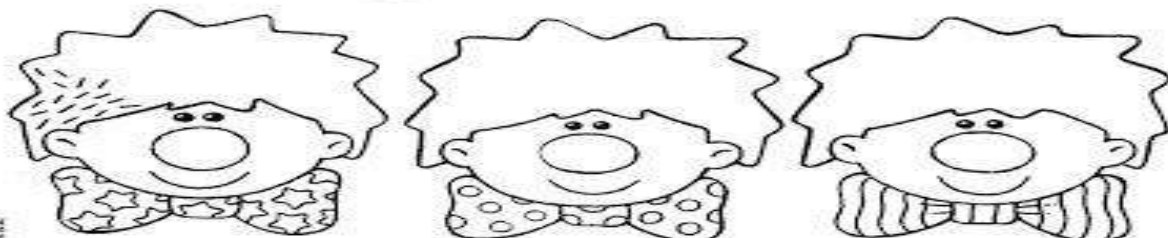
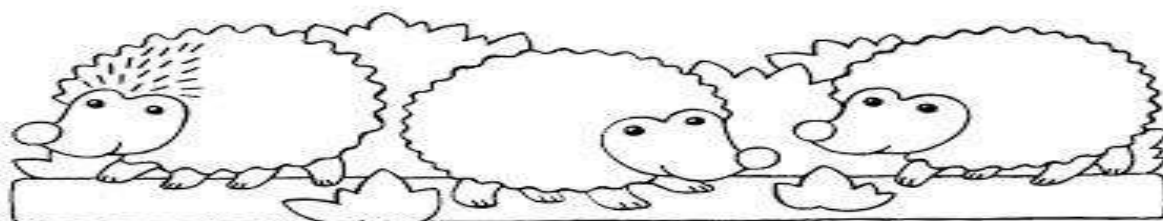

Este material no puede ser reproducido sin previa autorización de MLL EDUCACIÓN S.L.

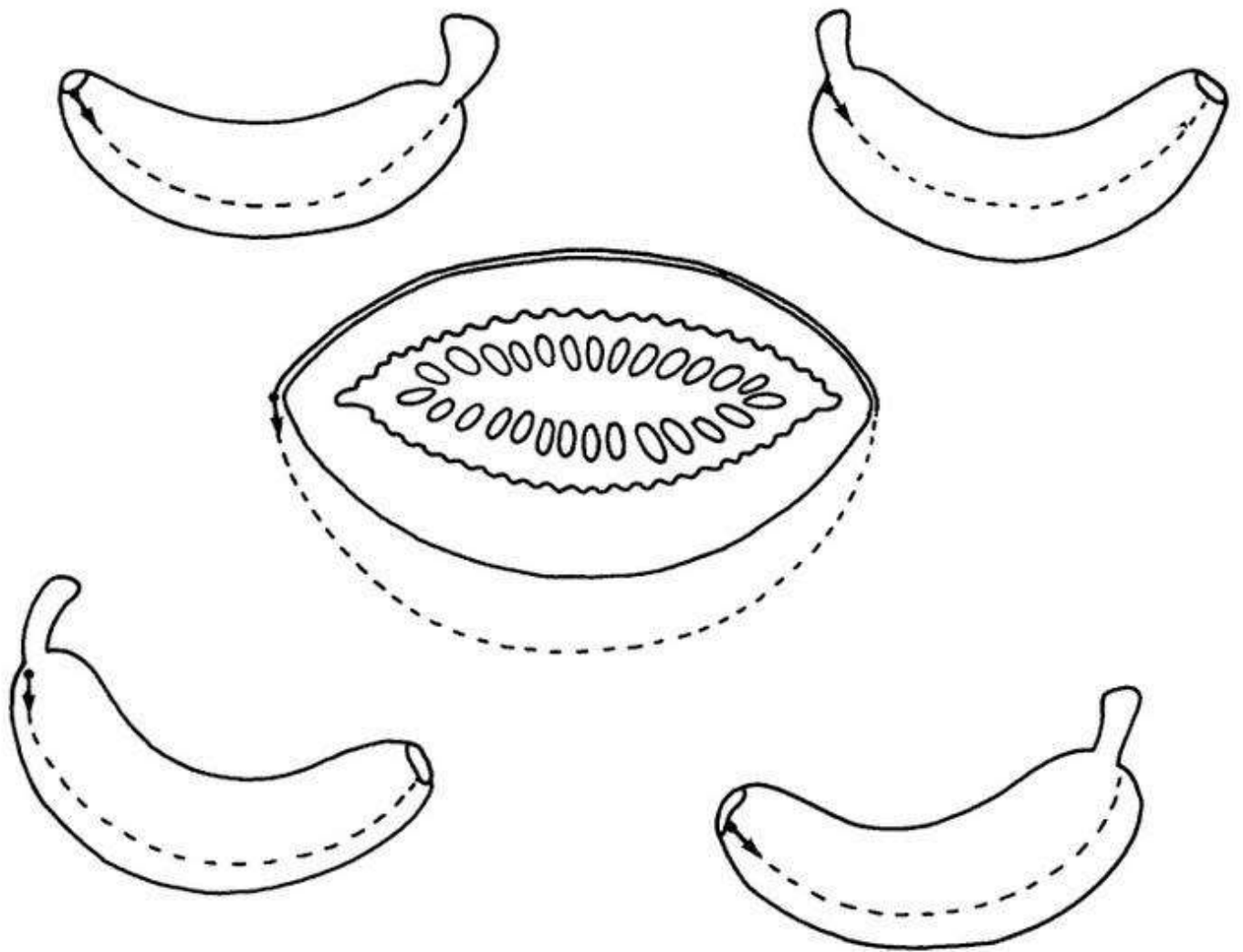

● CON LÁPICES DE DISTINTOS COLORES REPASÁ LAS LÍNEAS PUNTEADAS PARA AYUDAR A ESTA ARAÑA A PINTAR SU CASITA COLORIDA.

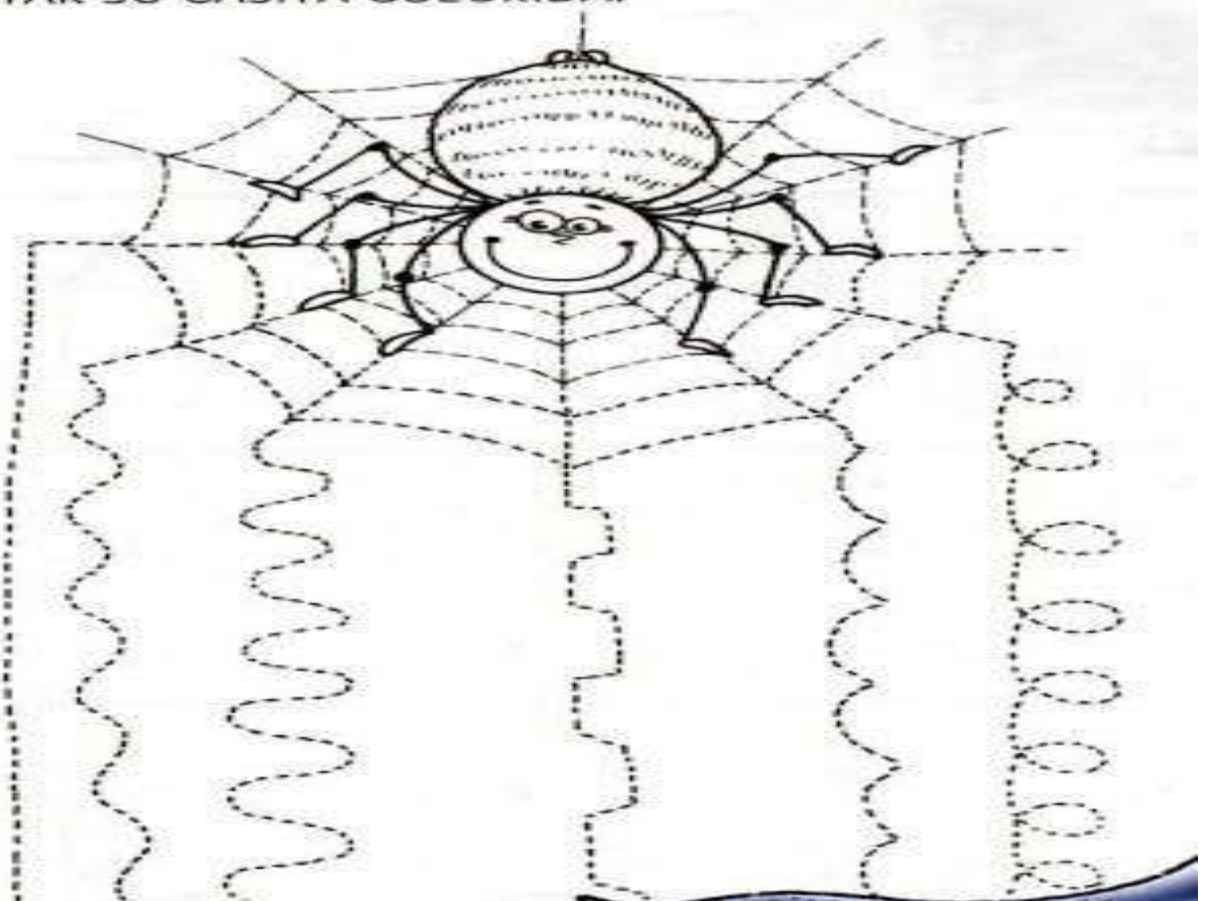

Name: \_\_\_\_\_

# Tracing Practice I

Directions: Trace each line from the apple to the pie.

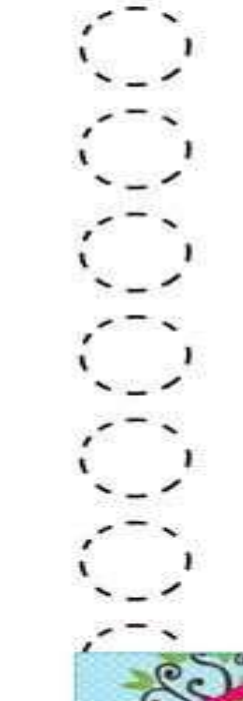
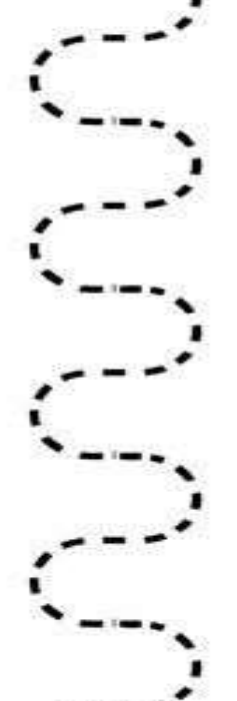
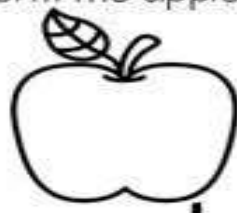
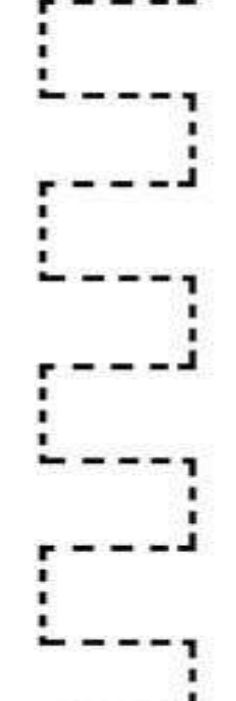
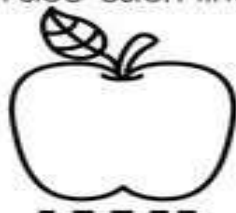
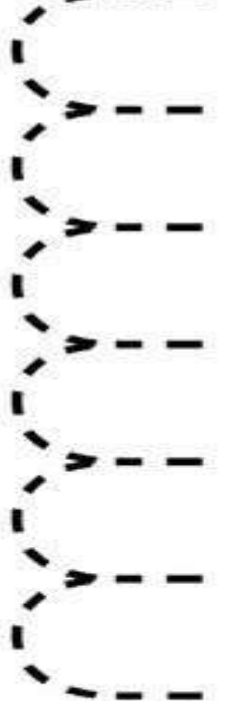

© The Moffatt Girls 2015

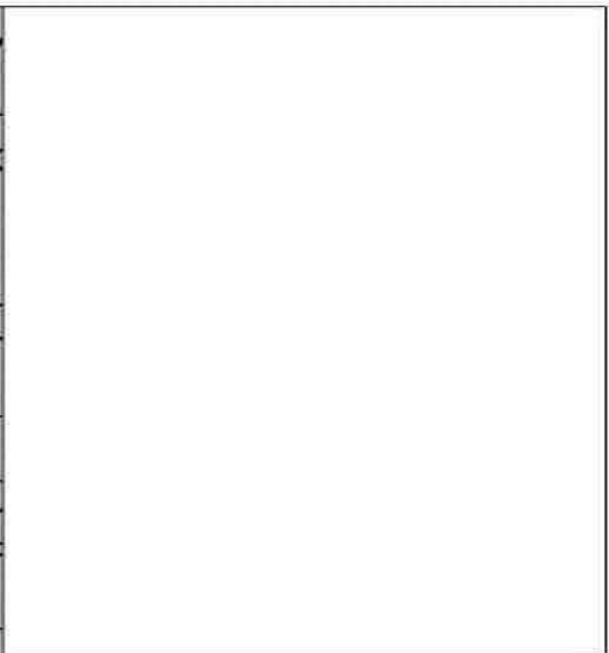

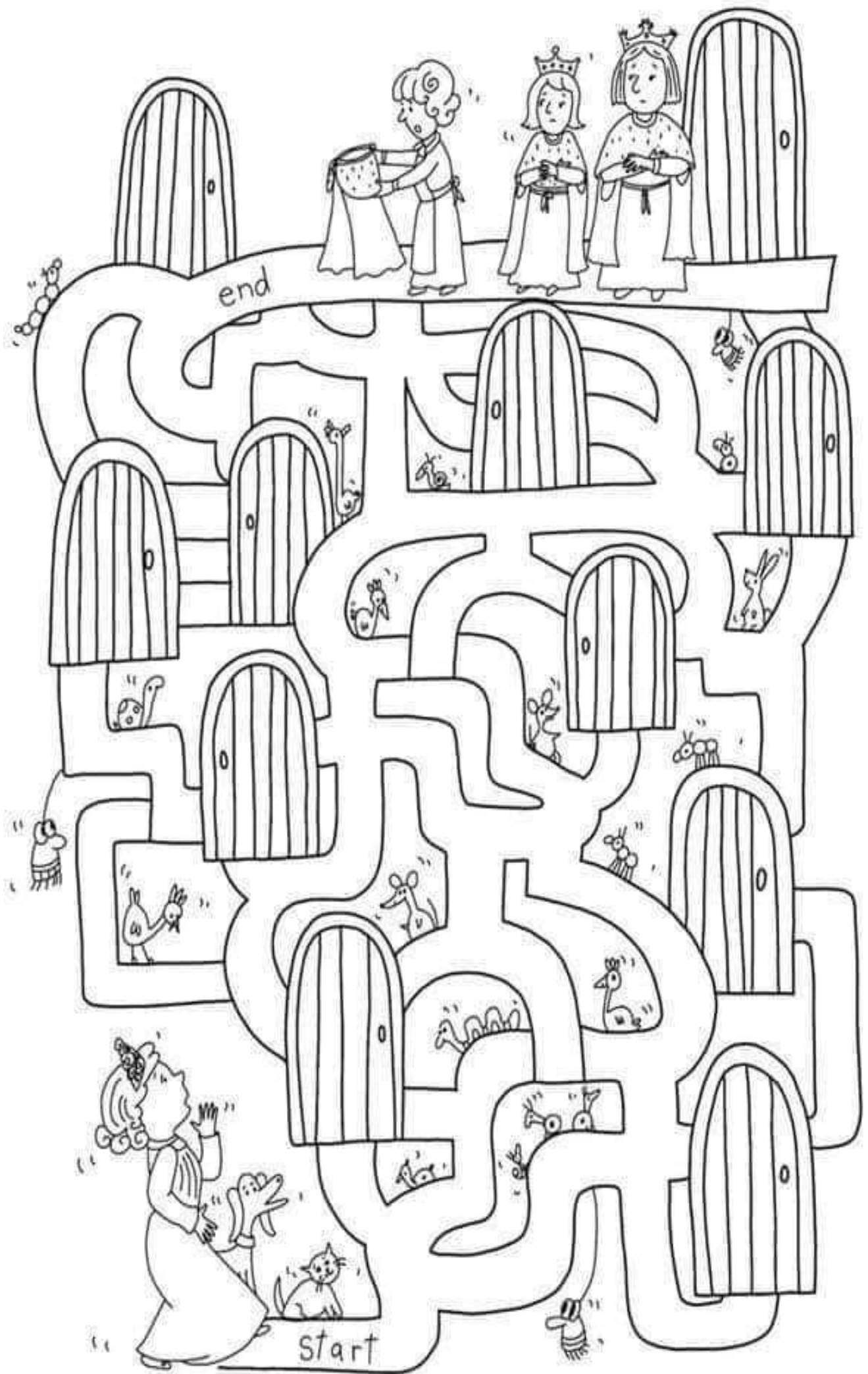

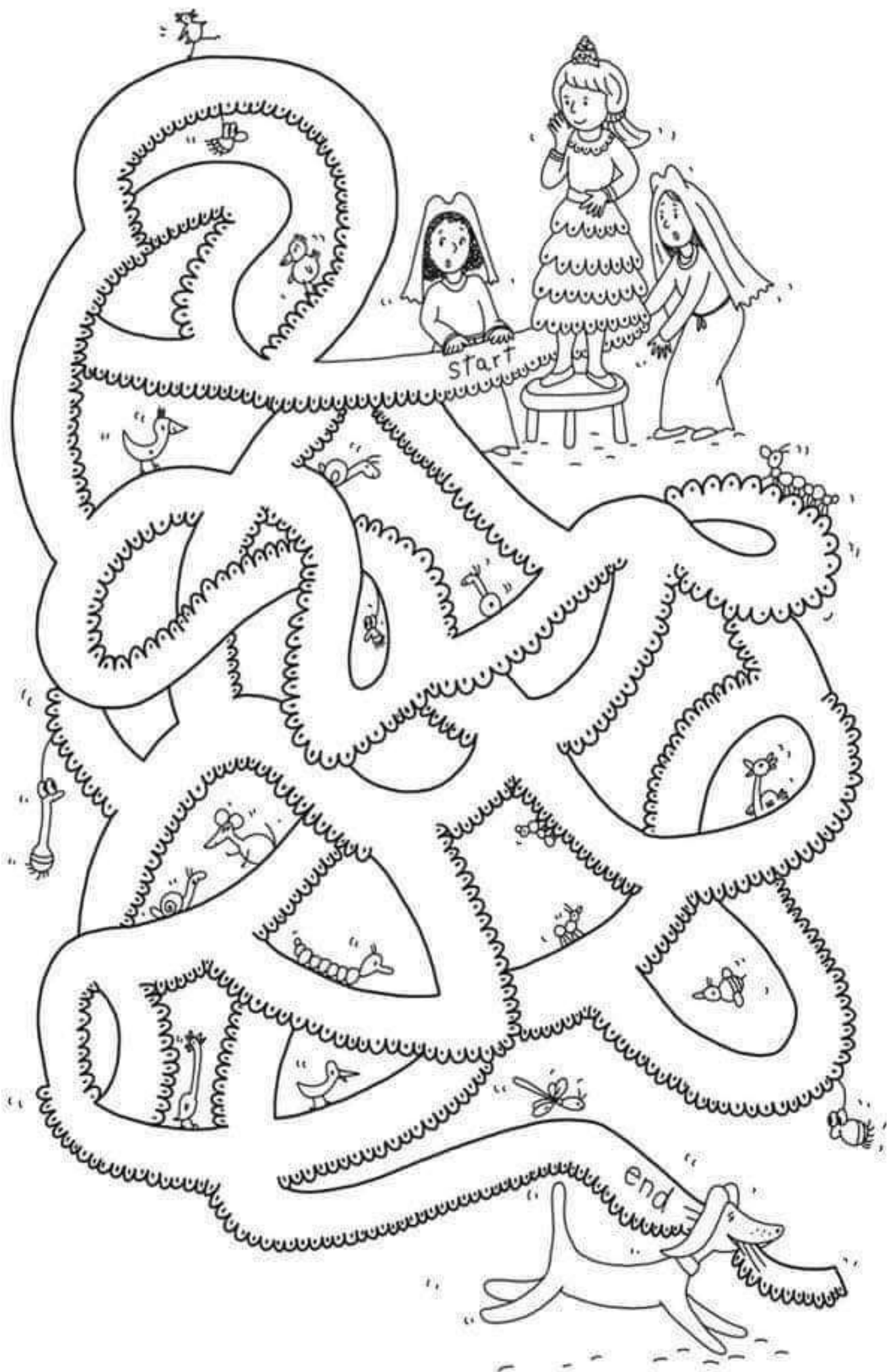





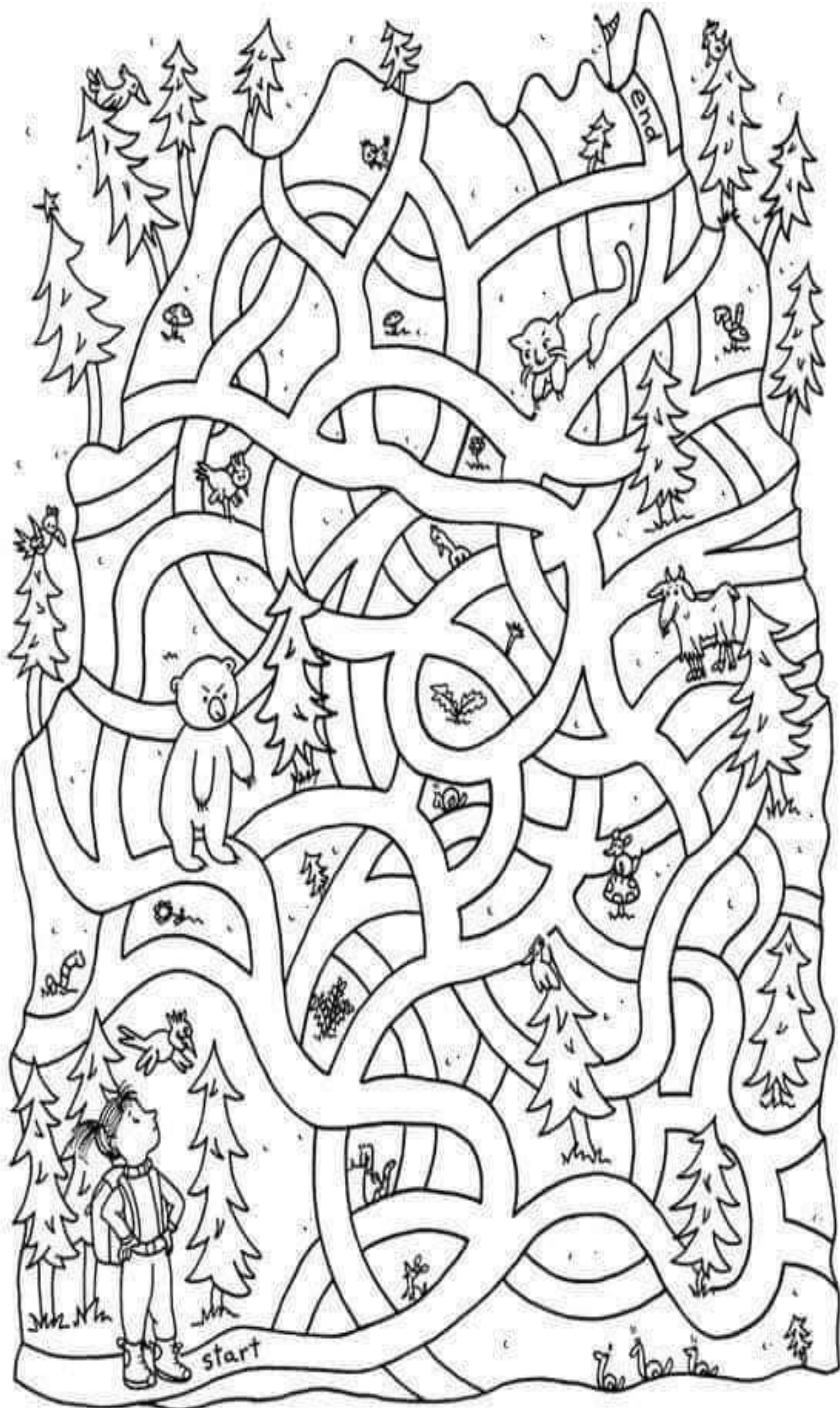

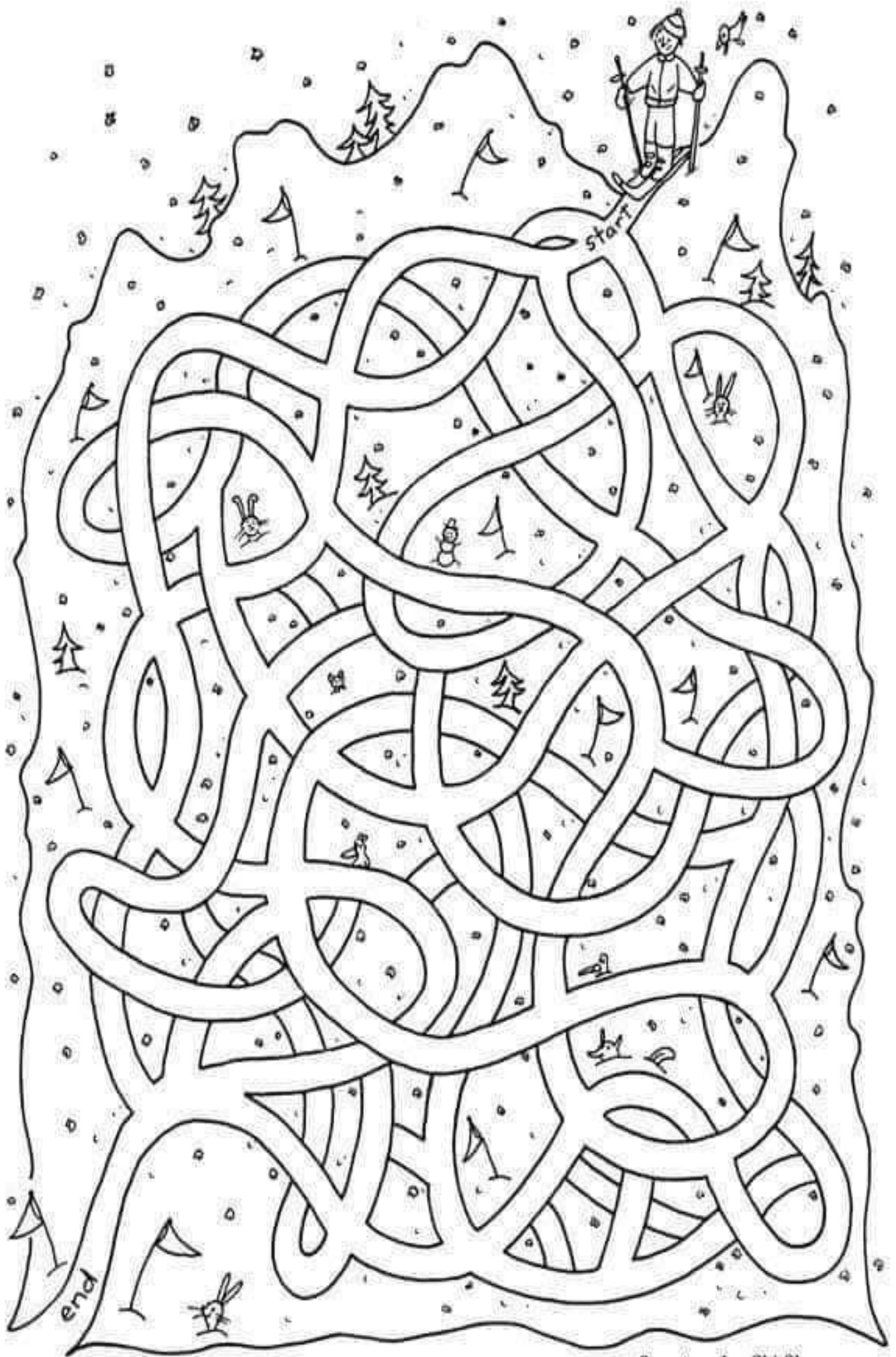

Spectacular Ski Slope

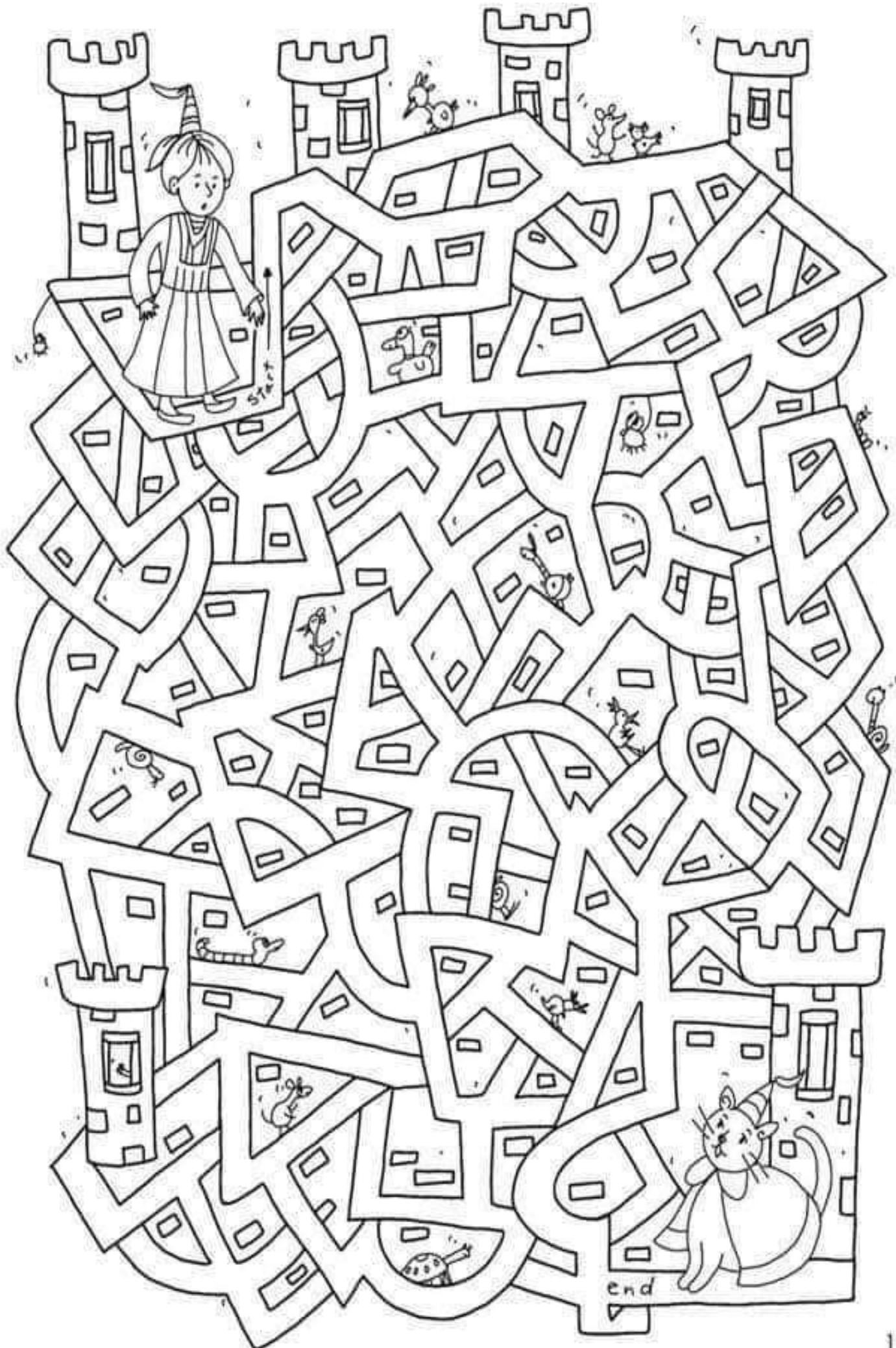





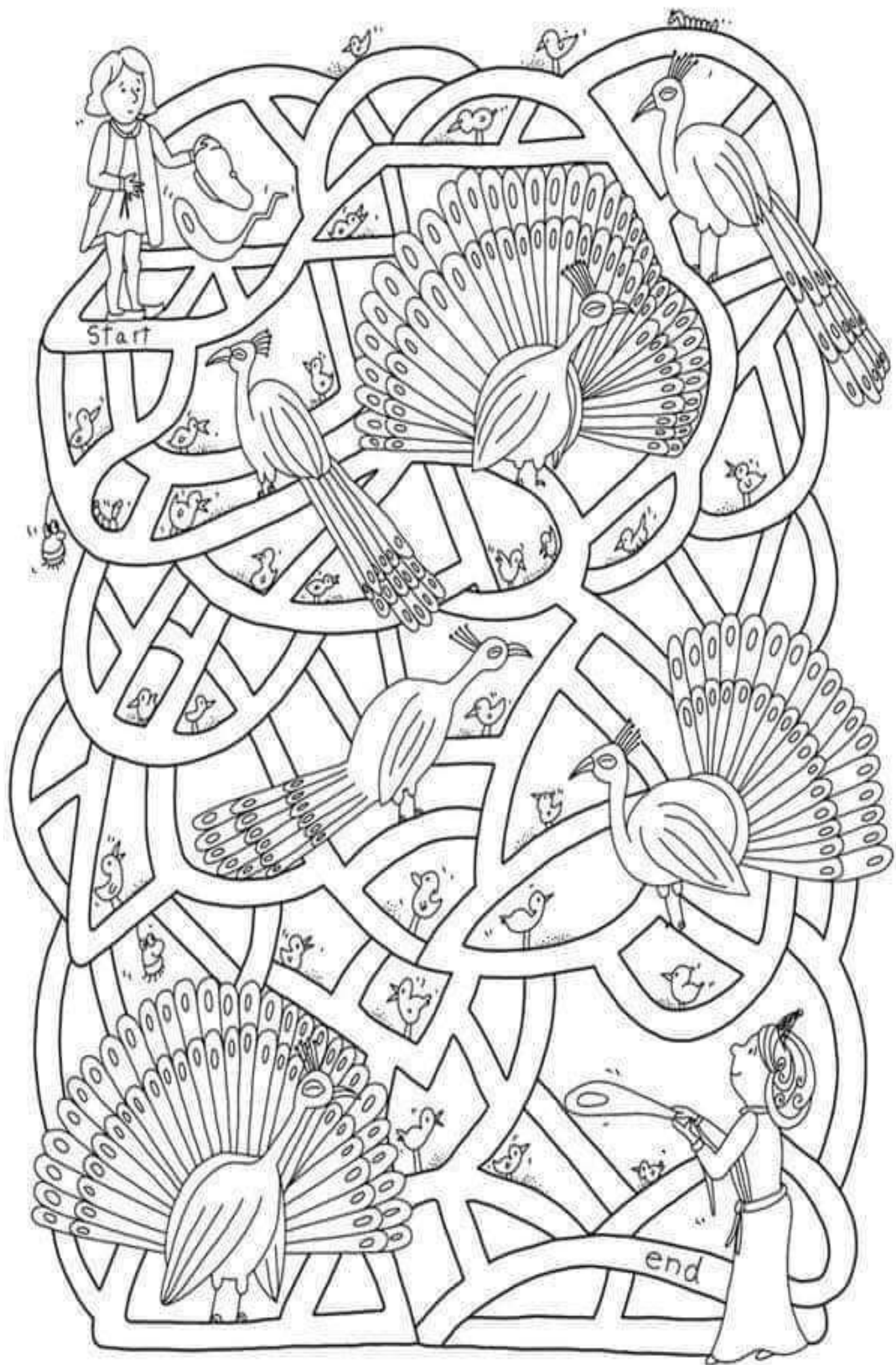

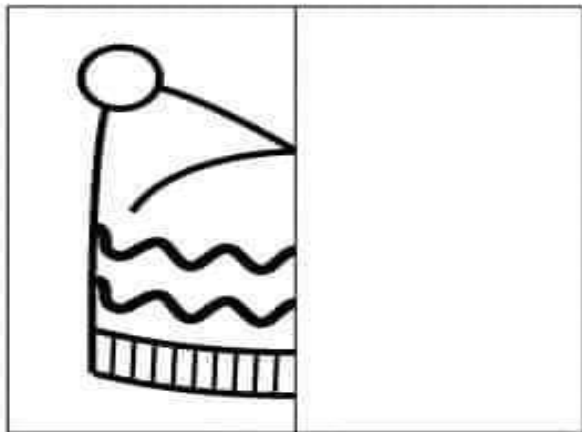
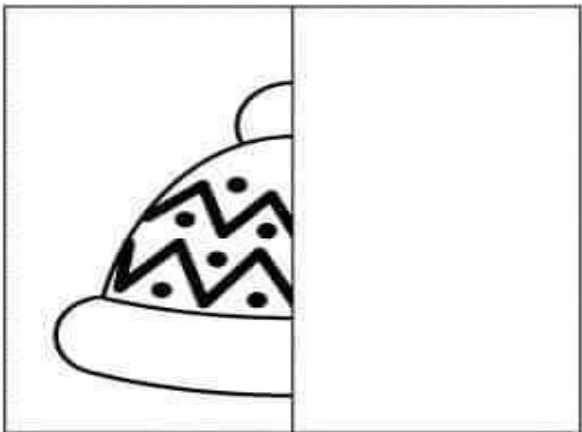
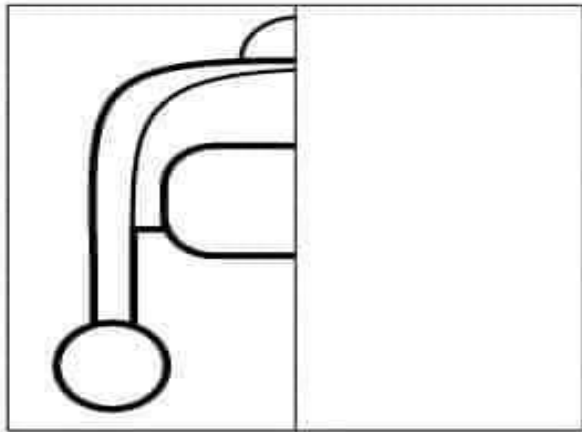
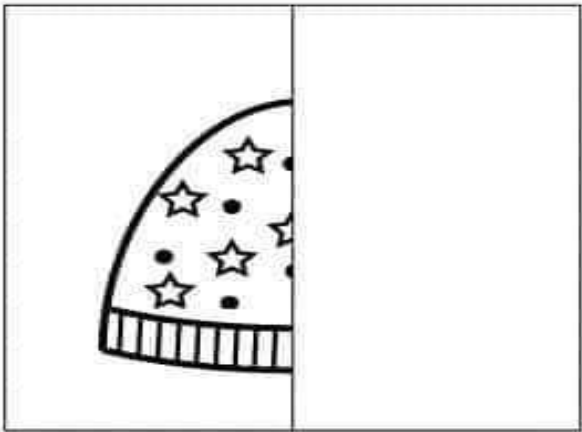
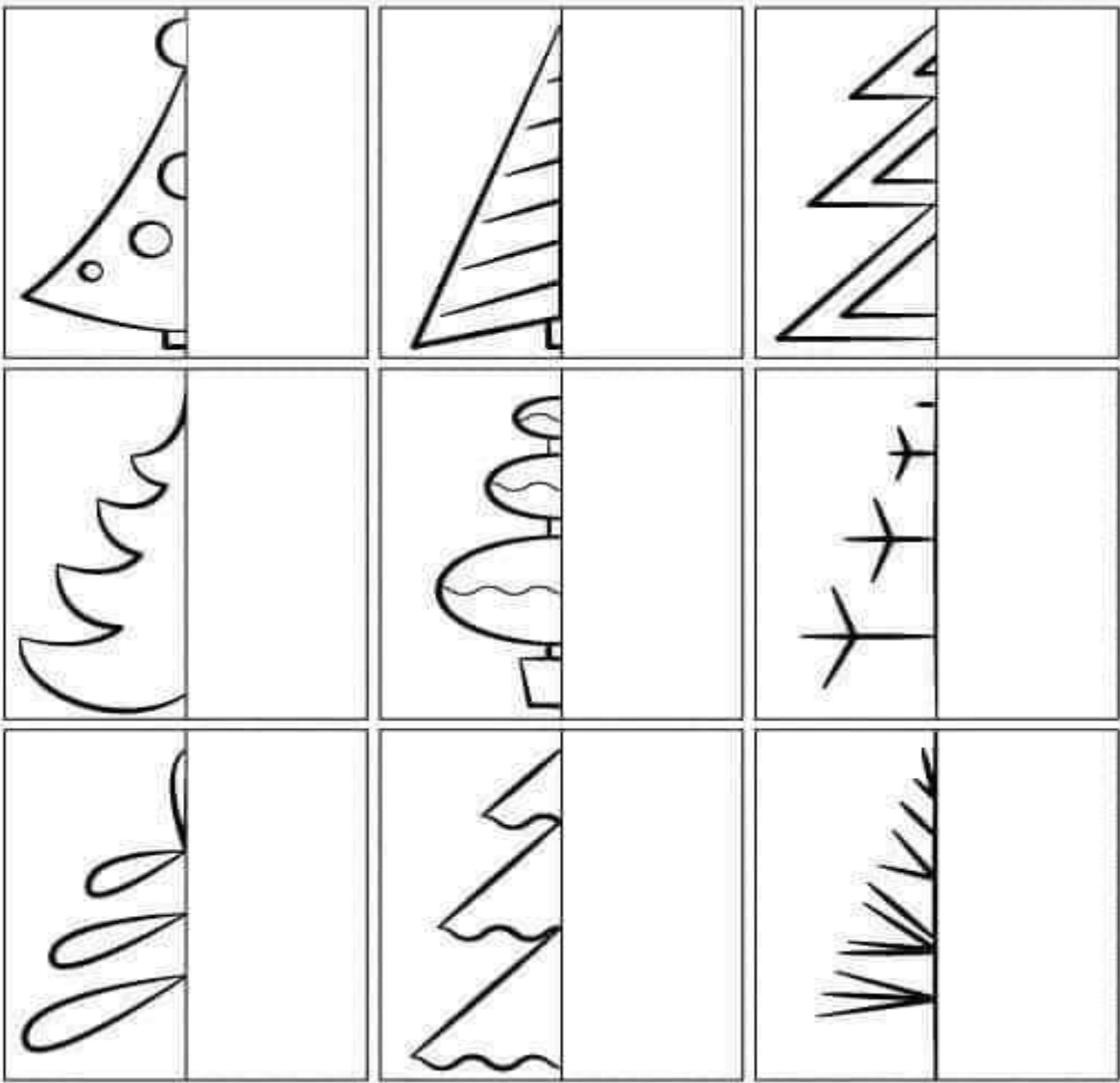

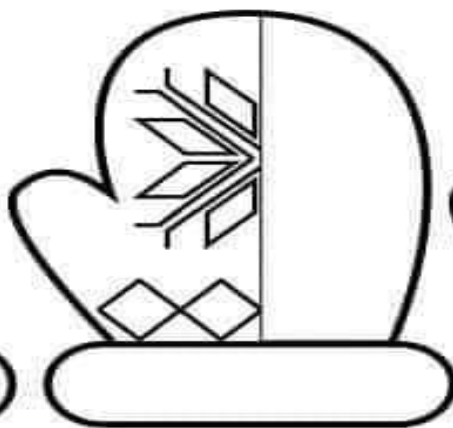
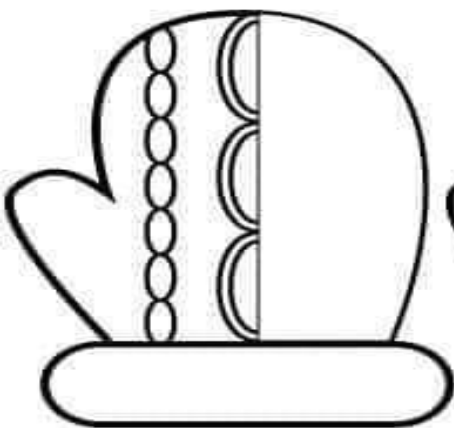
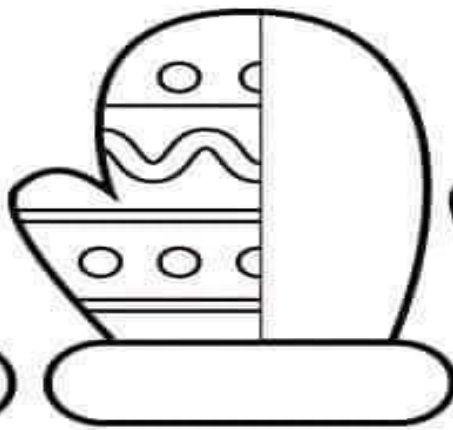
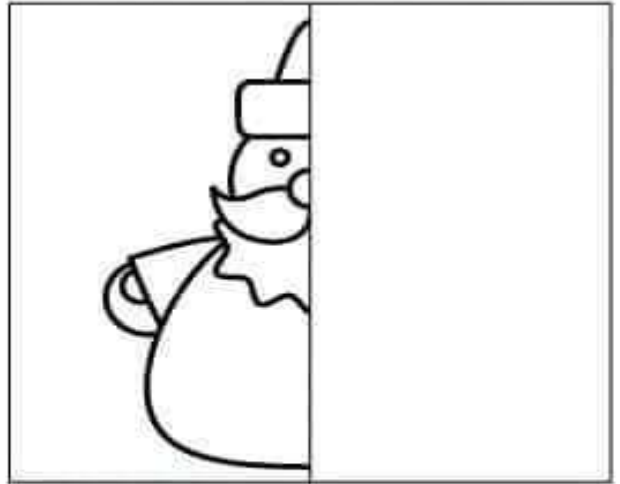
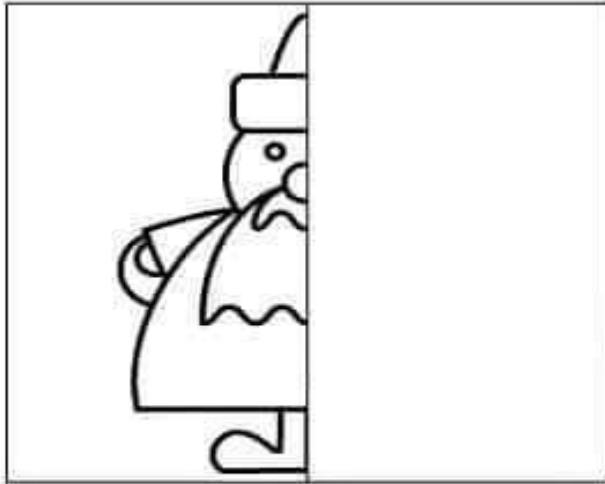
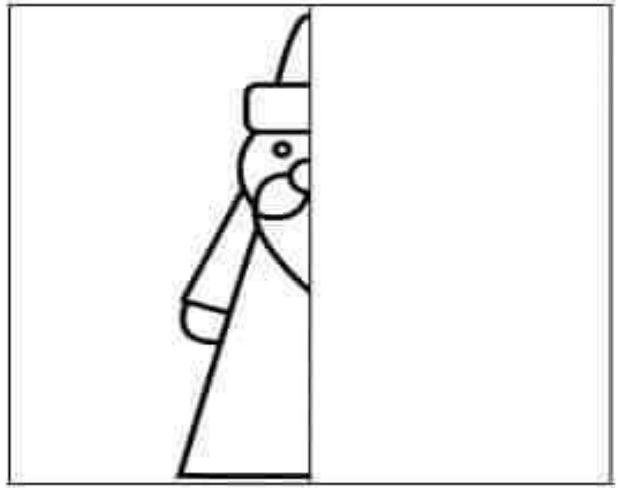
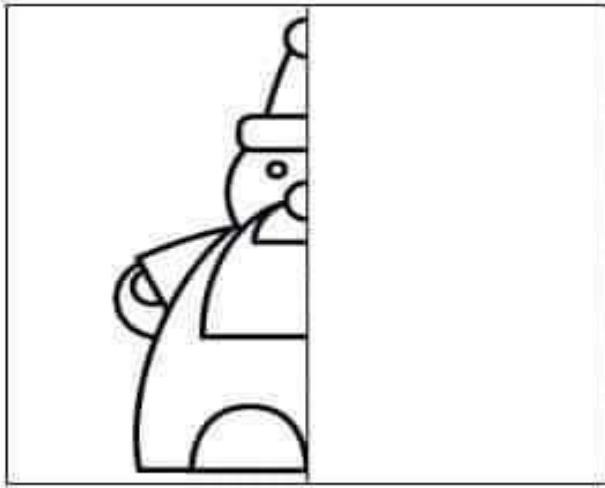



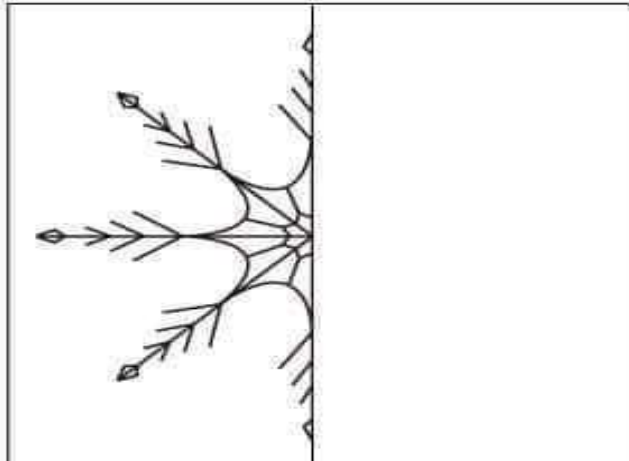
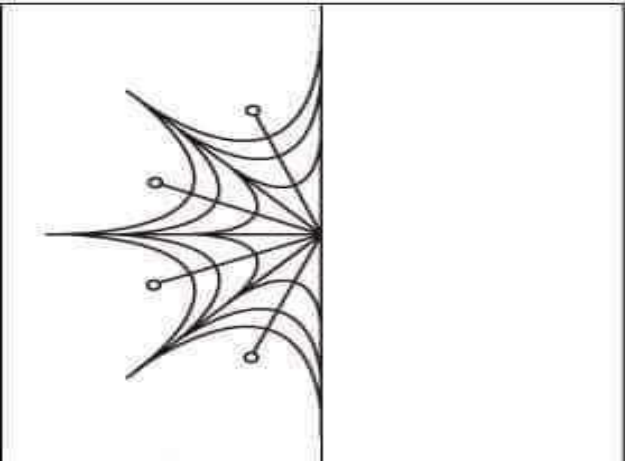
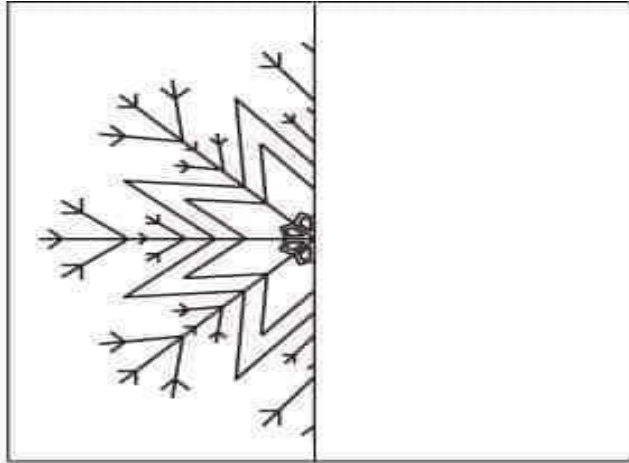
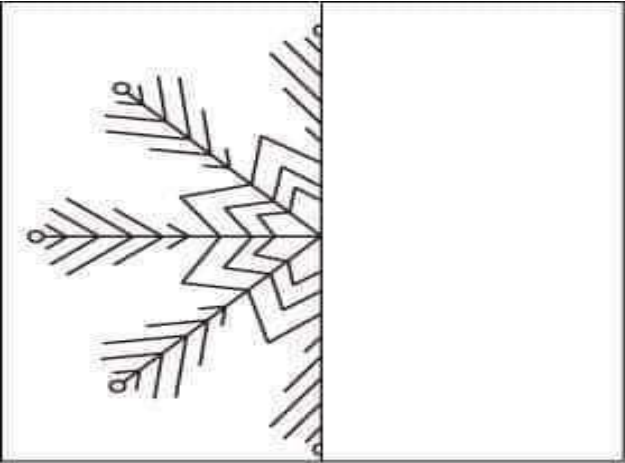
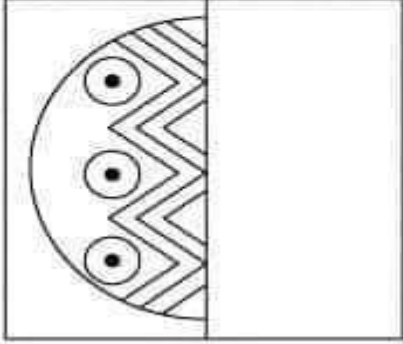
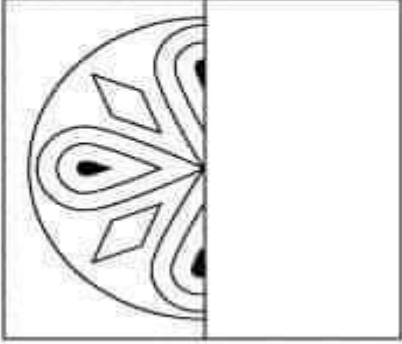
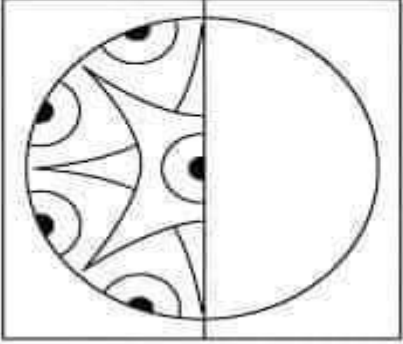
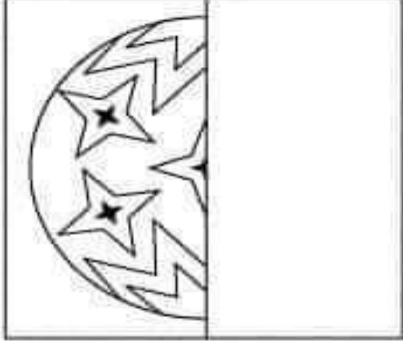
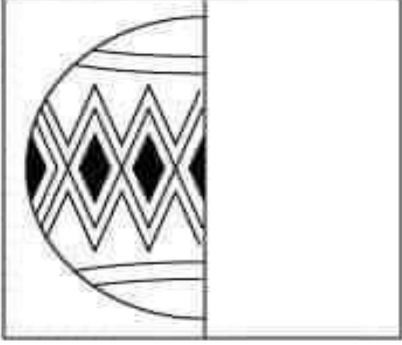
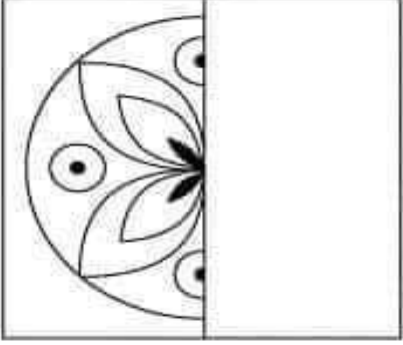
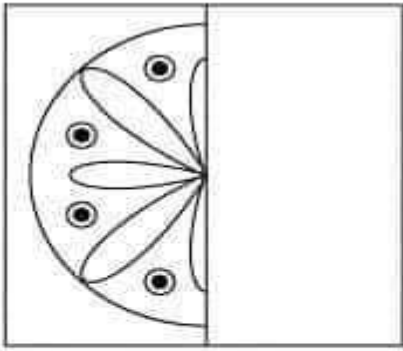
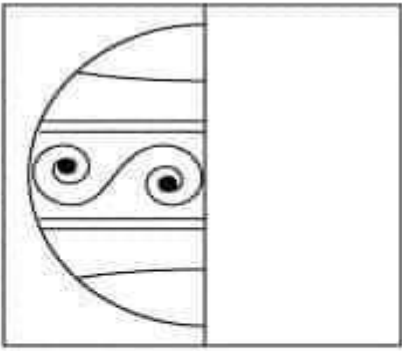
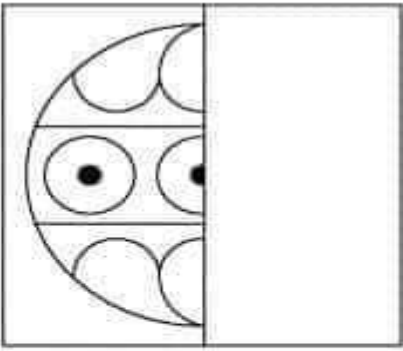

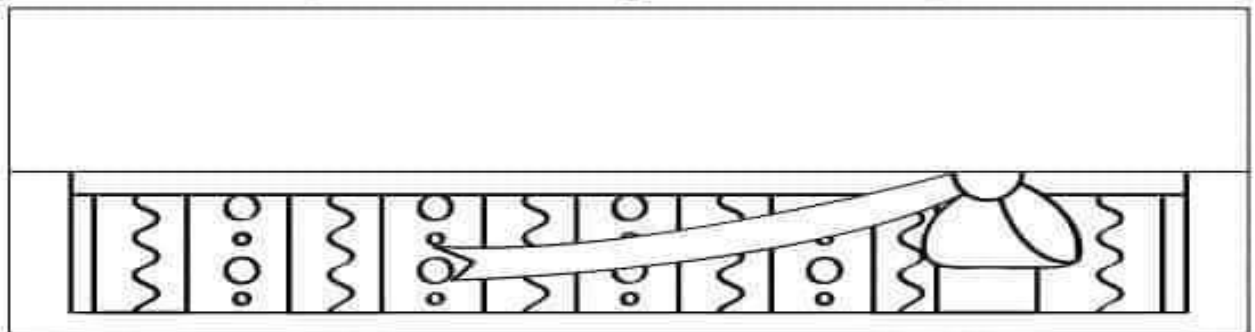
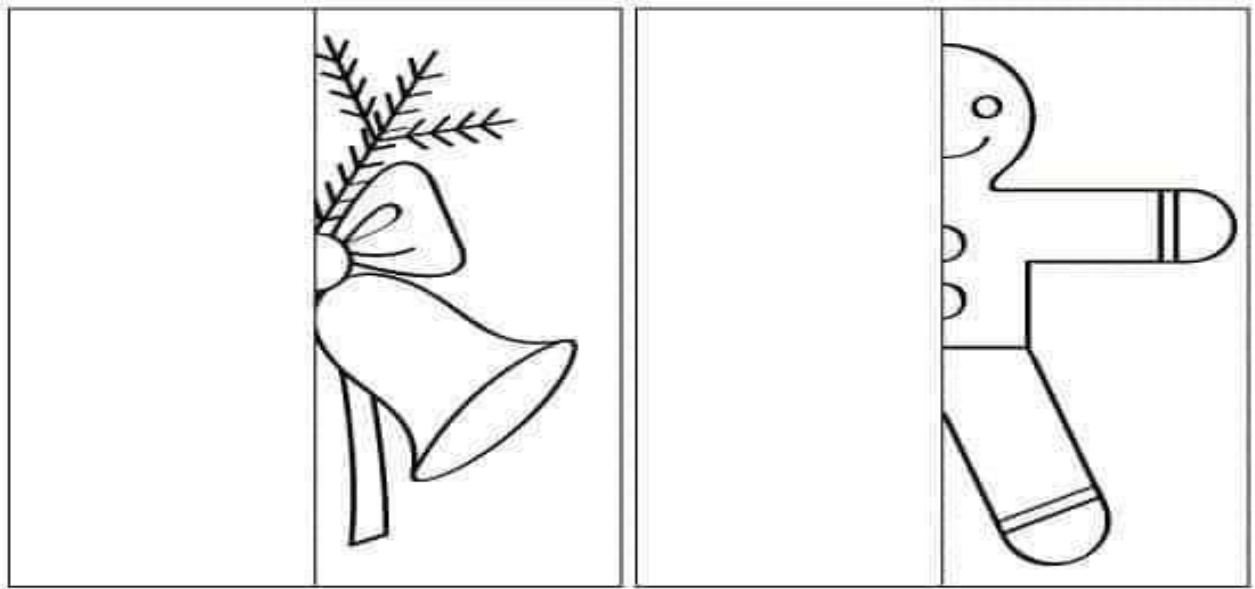
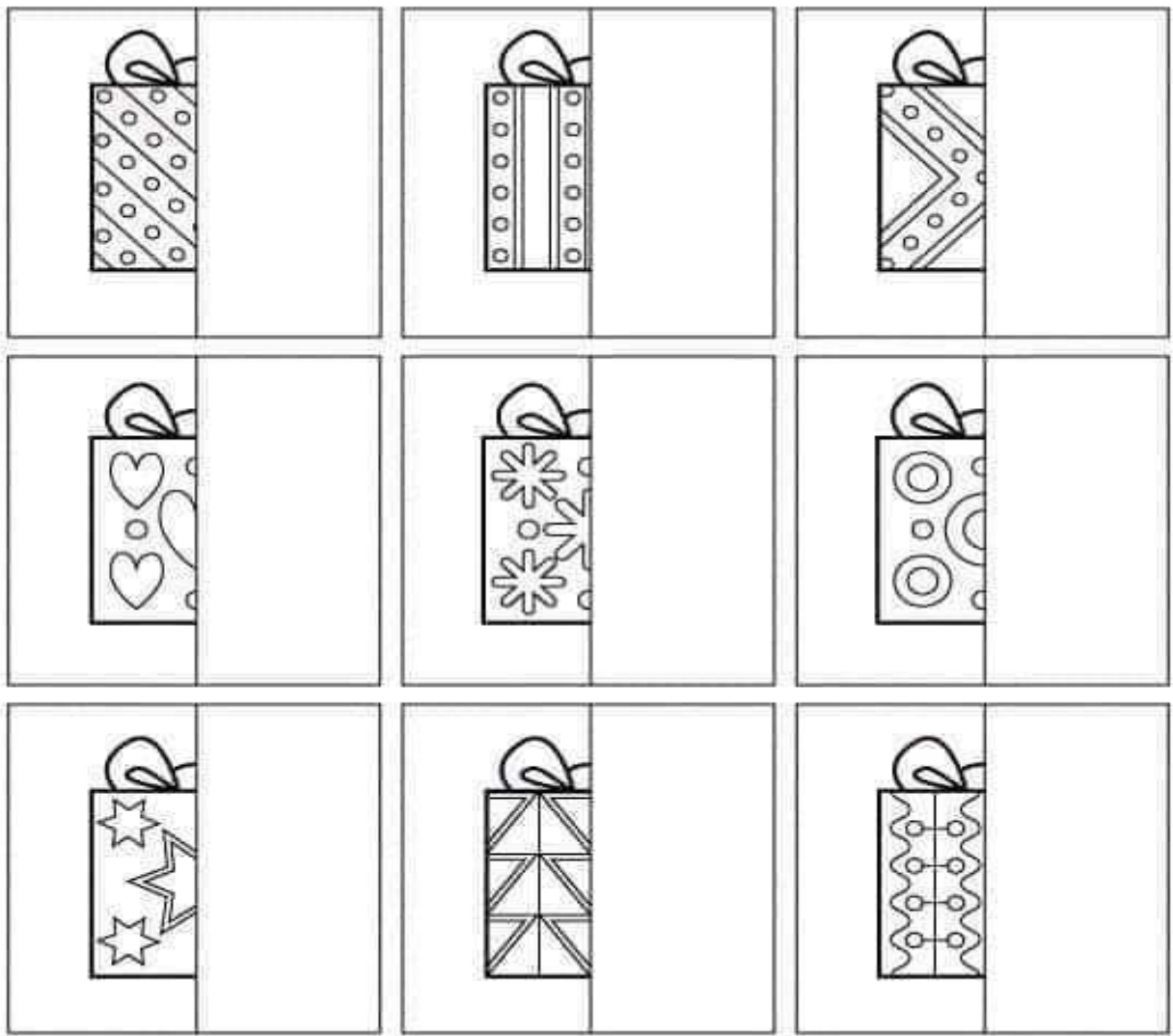

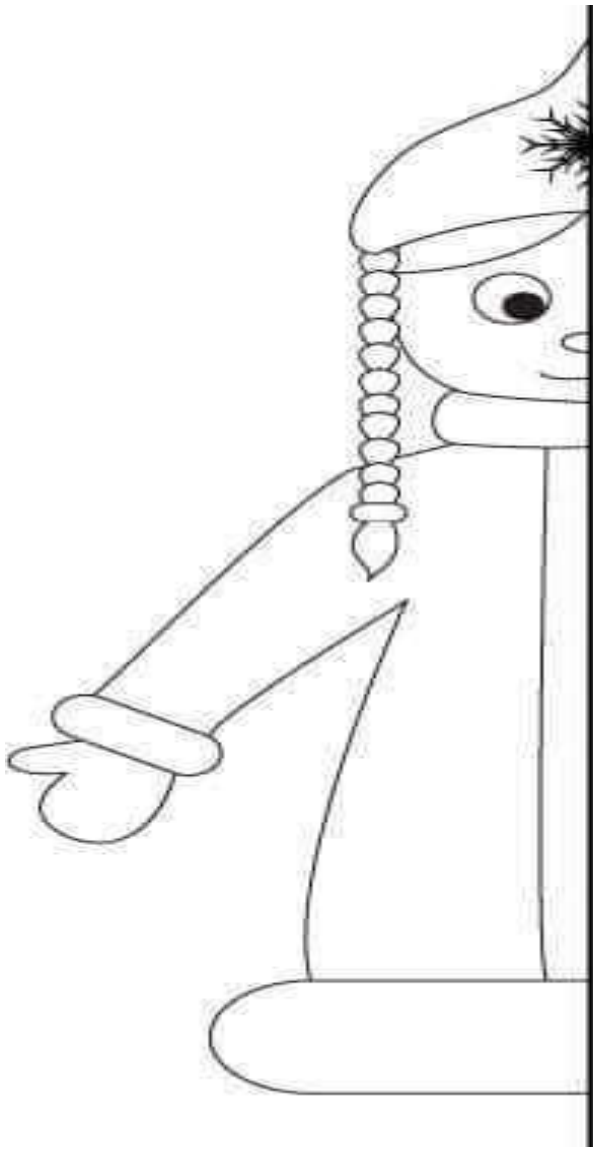

Probeer die een maatjie by die ander een te kry met 'n vetkryt.  
Onthou om binne die lyne te bly en nie die kante te raak nie.

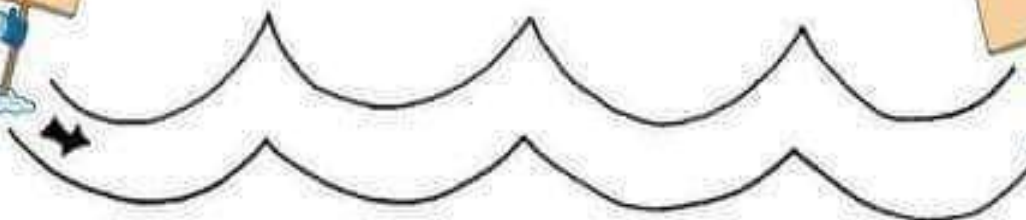
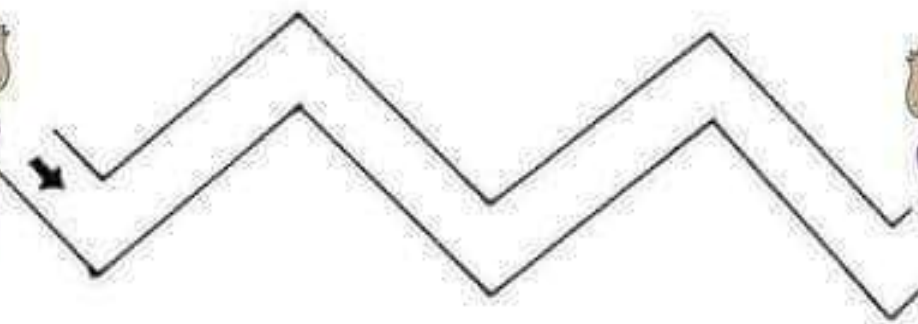
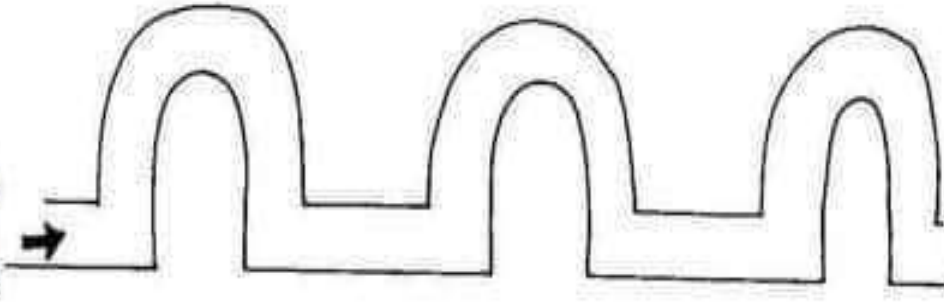
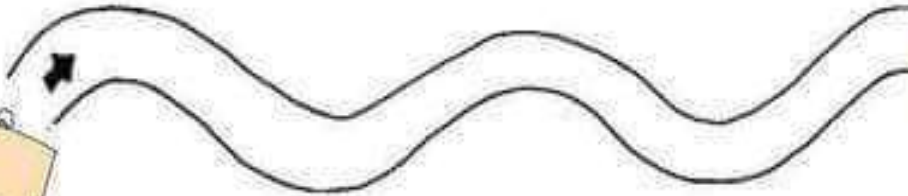
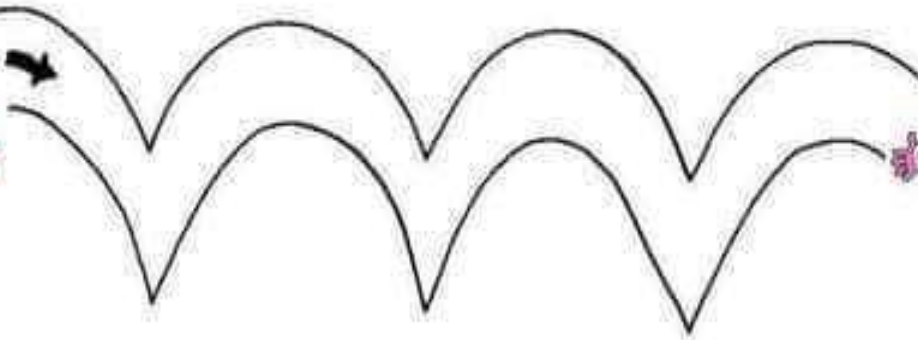

*Sport jij mee met de sneeuwpoppen?  
Trek met een potlood lijnen over hun sporen heen.*

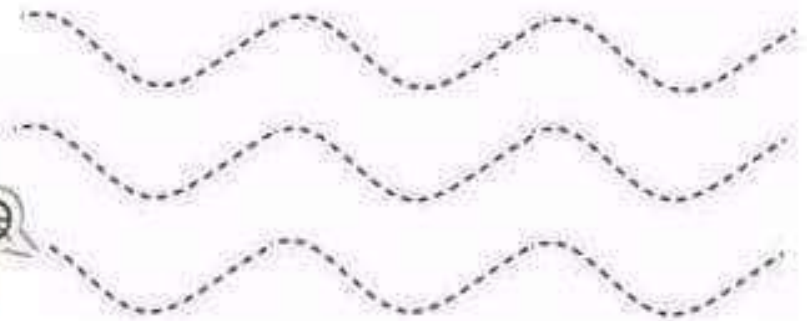
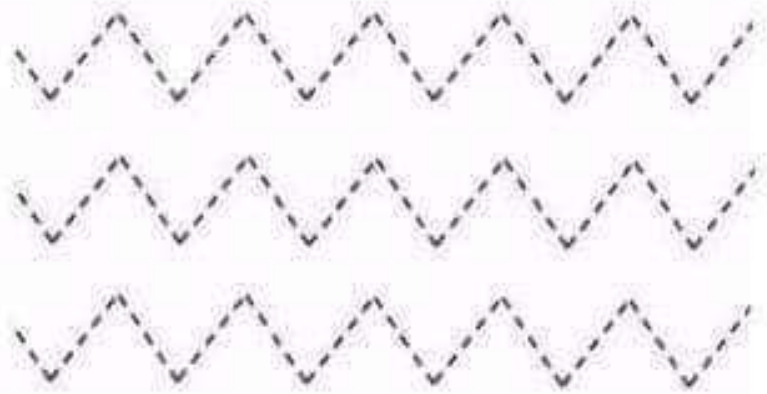

©kleuteridee.nl

alleen voor direct gebruik met kleuters

Trace les lignes en suivant les pointillés

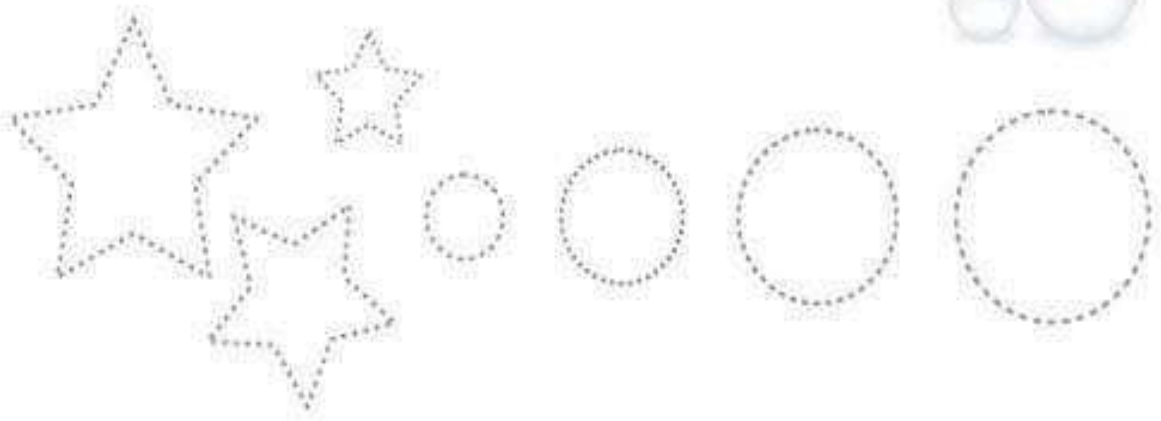
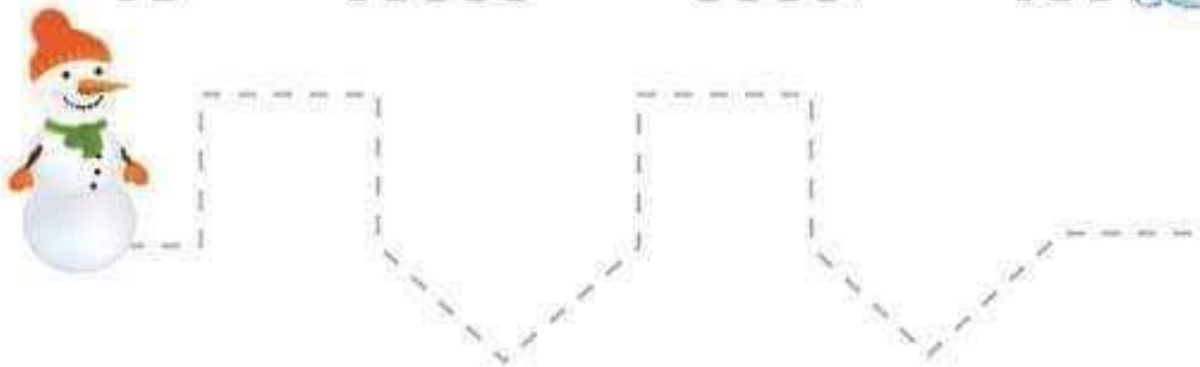
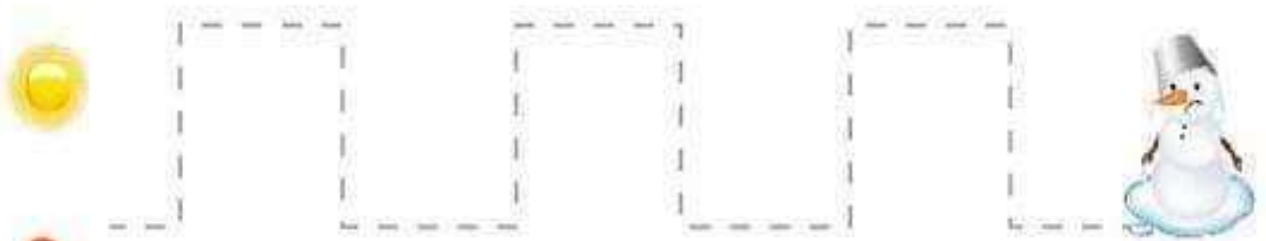

Положи подарки под ёлочку!



Nombre: \_\_\_\_\_

# Grafomotricidad navideña

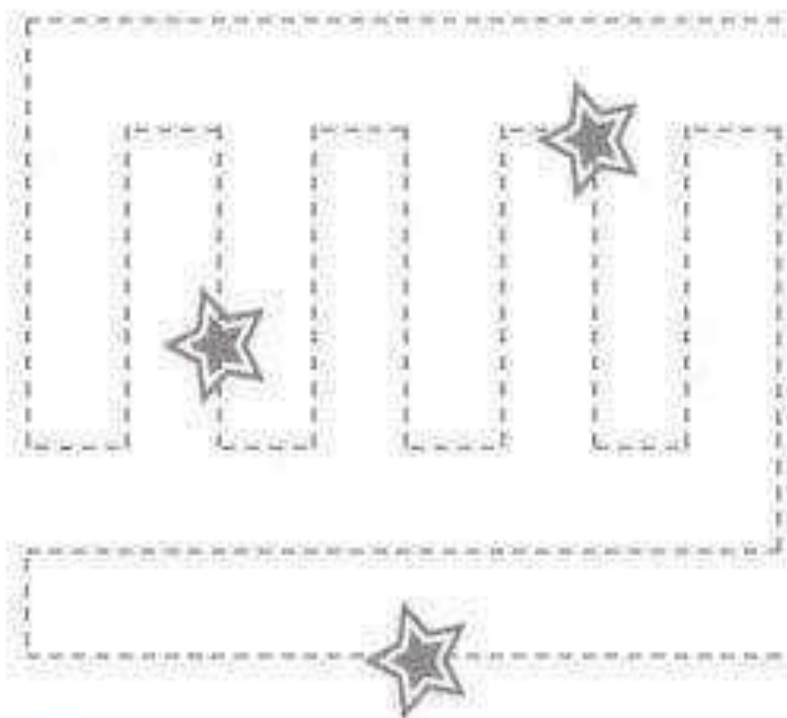
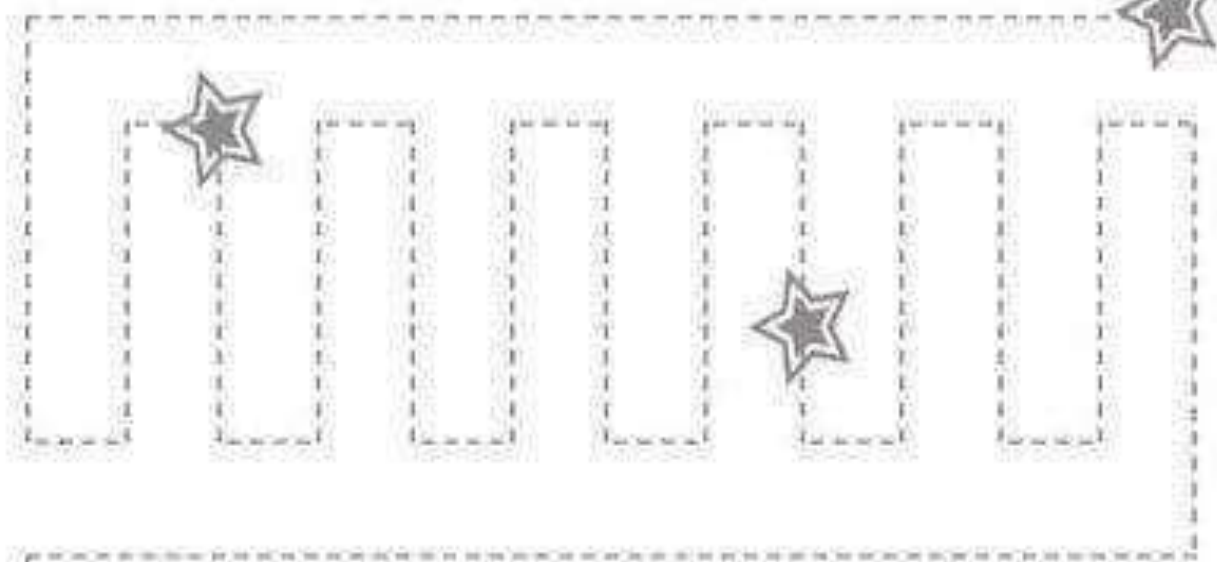
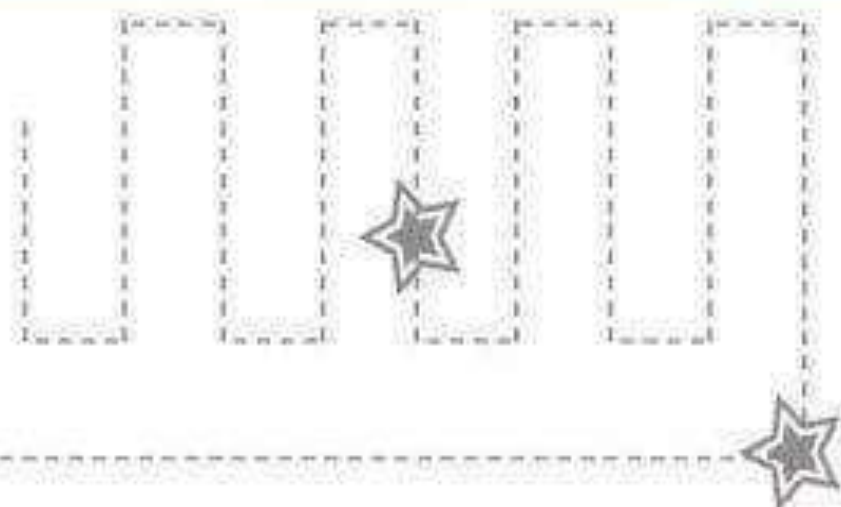



Name: \_\_\_\_\_

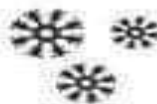

Trace the dotted lines from top to bottom.

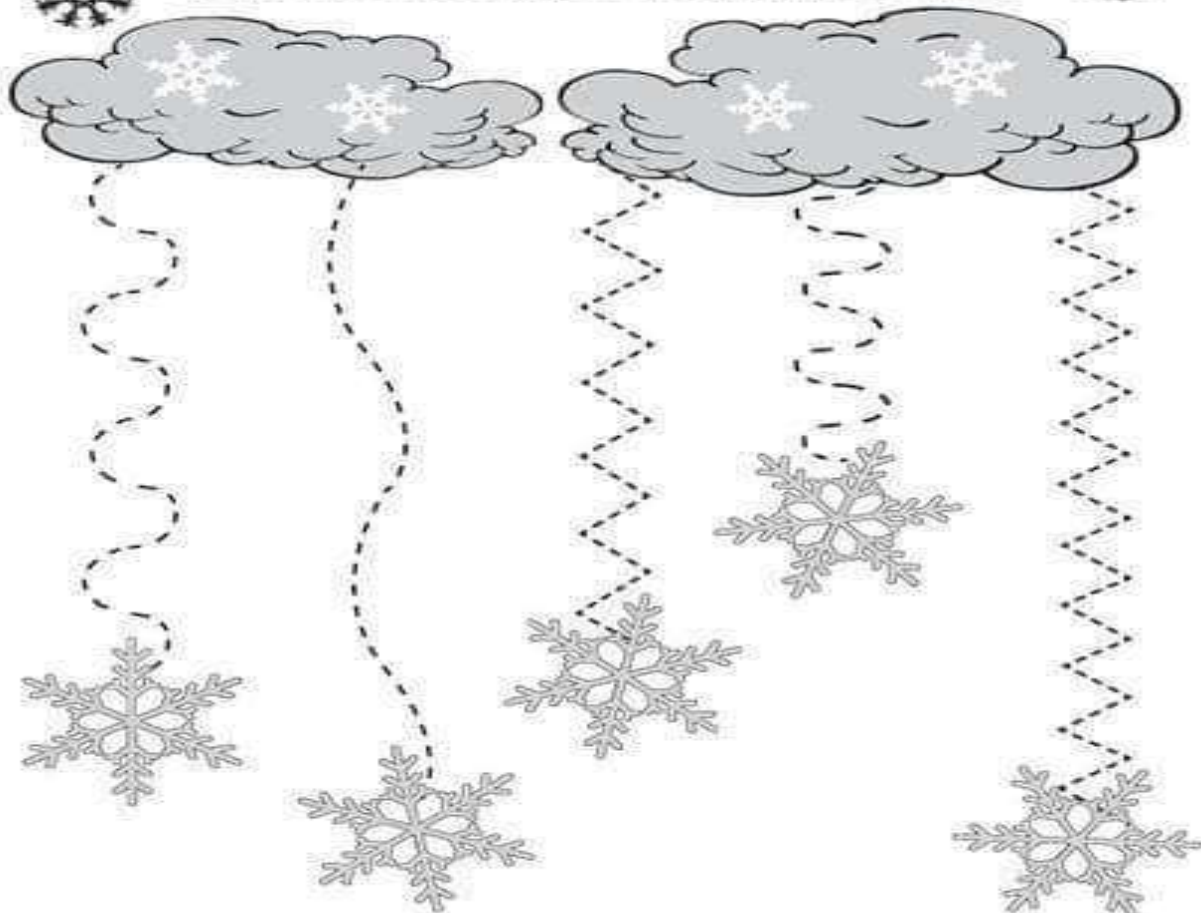

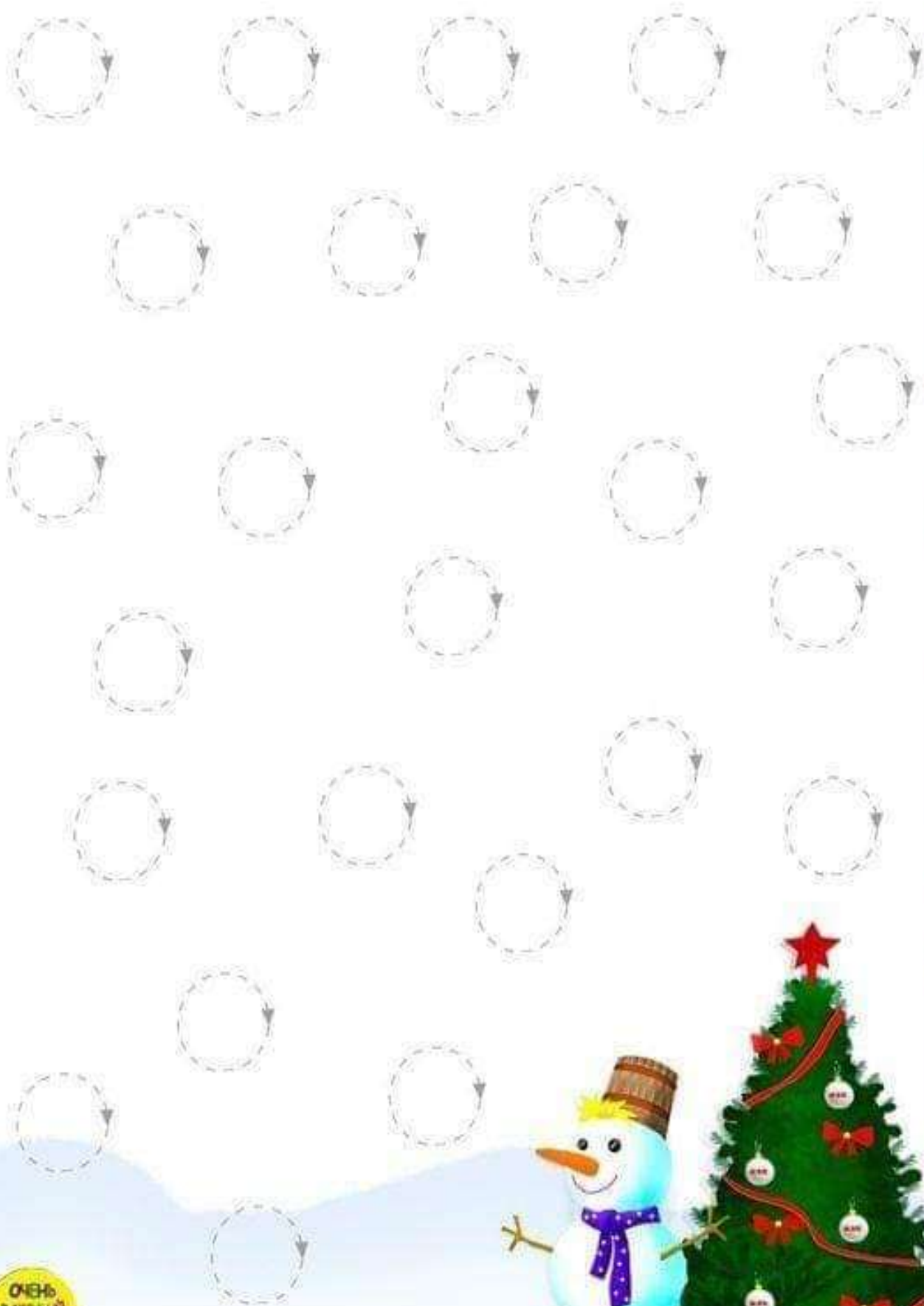

Очень  
важный  
канал

Очень  
важный  
канал



Handwriting practice lines consisting of ten vertical columns. Each column contains a dashed line for tracing, with a solid line on the left and another dashed line on the right, creating a narrow channel for the letter 'Y'. The lines are evenly spaced and extend from the top of the page down to the footer area.

ОЧЕНЬ  
САМОЙ  
КАРАТ

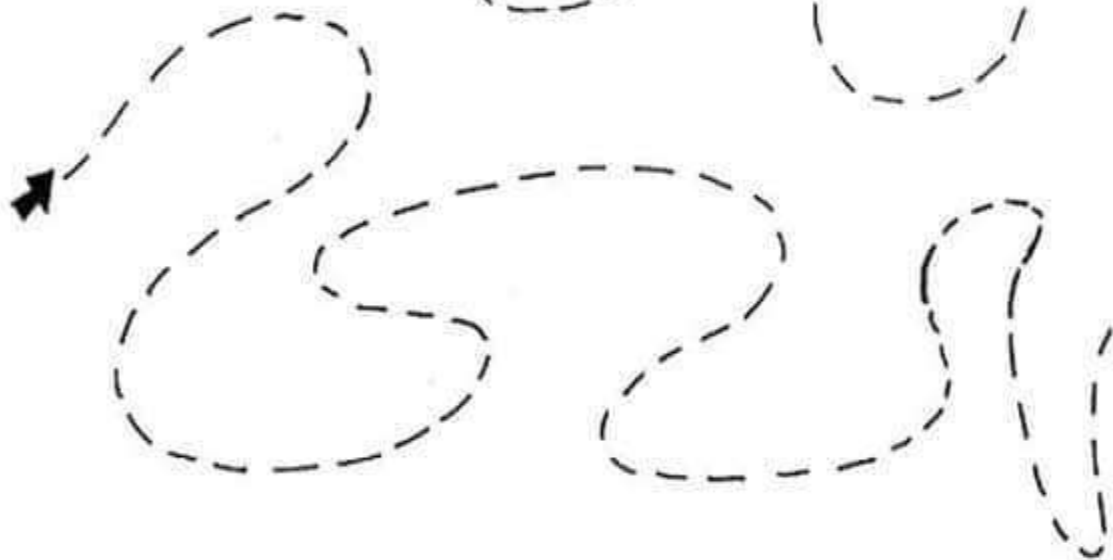
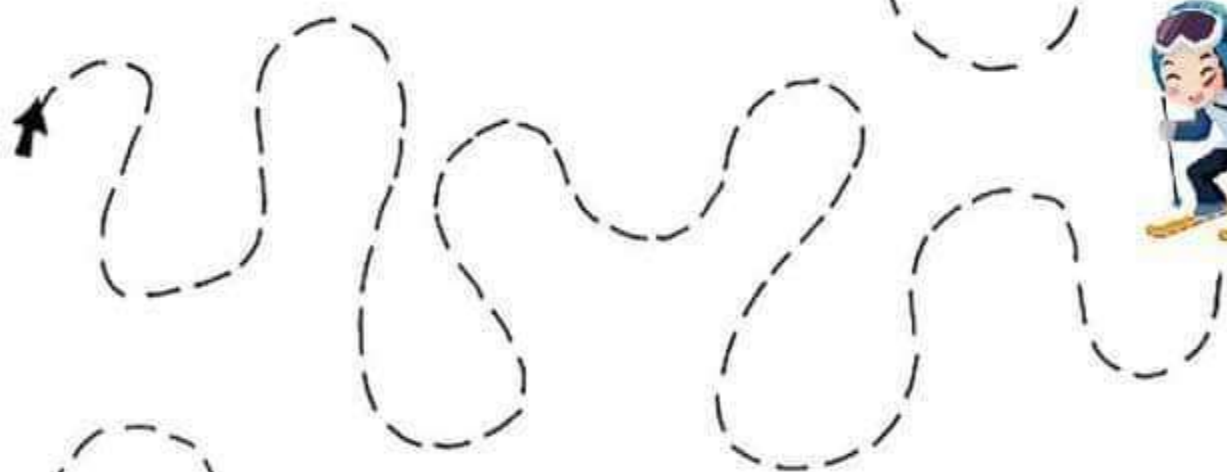

Очень  
Большая  
Корзина

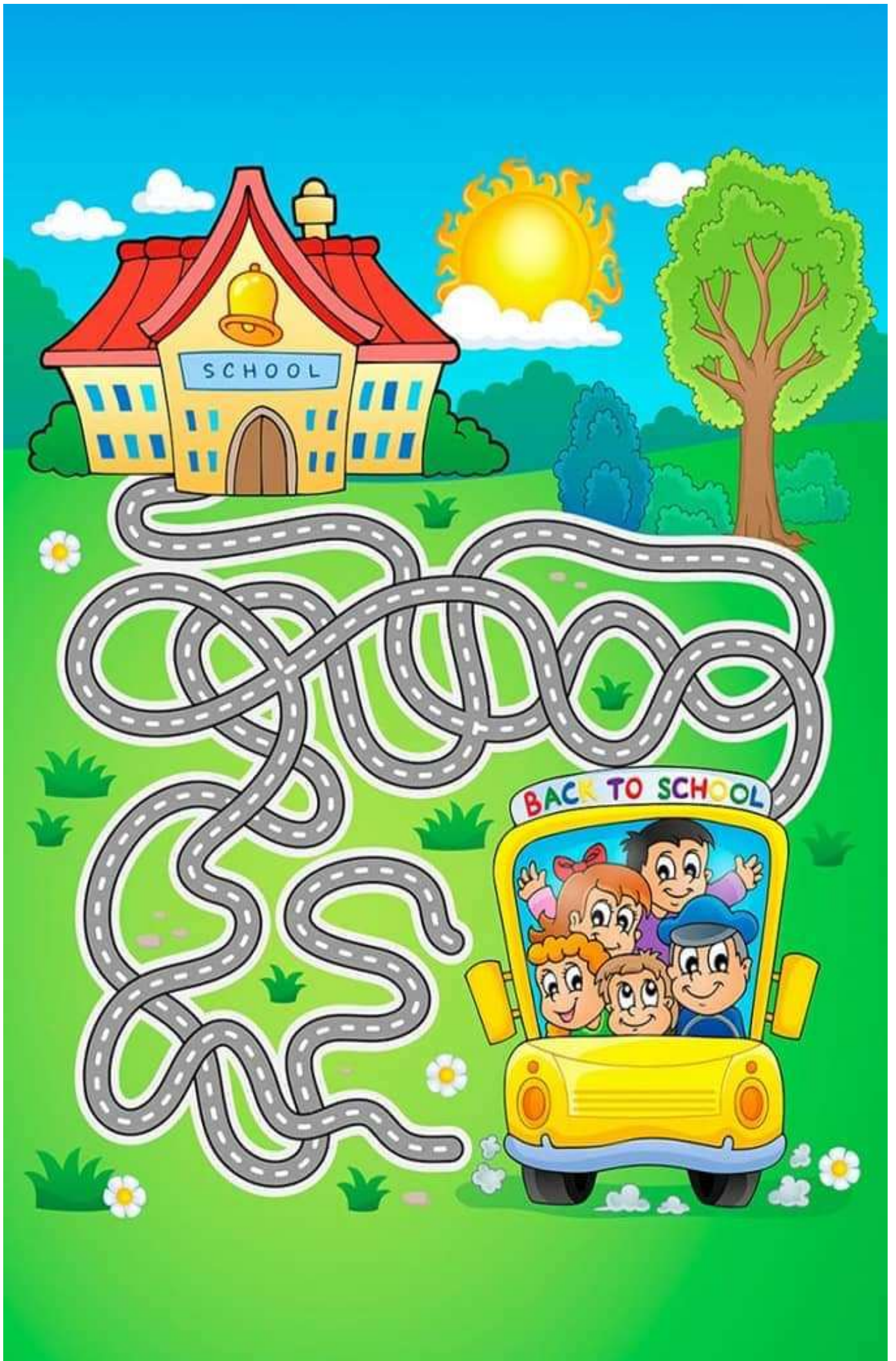





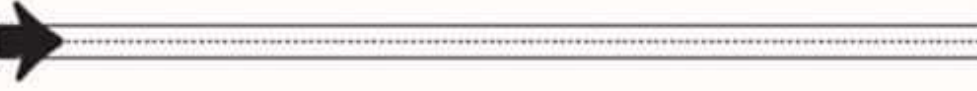



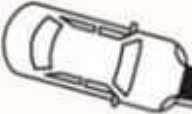
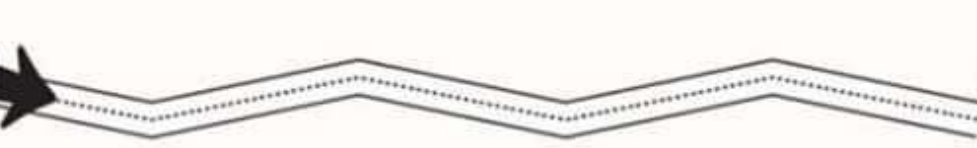

Nombre: \_\_\_\_\_ Fecha: \_\_\_\_\_

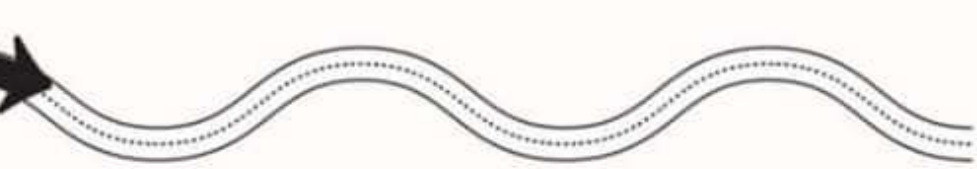



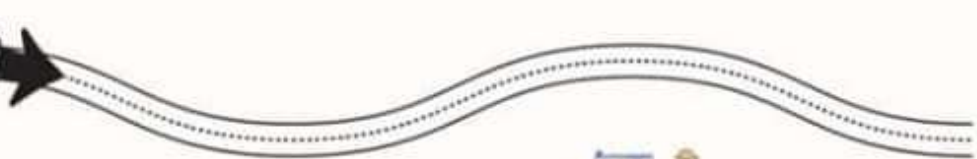

Nombre: \_\_\_\_\_ Fecha: \_\_\_\_\_

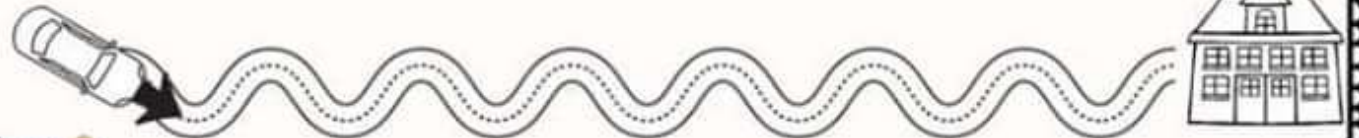
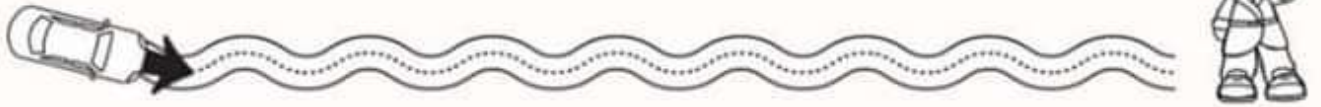
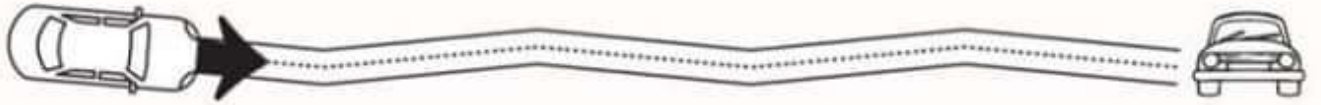

Nombre: \_\_\_\_\_ Fecha: \_\_\_\_\_

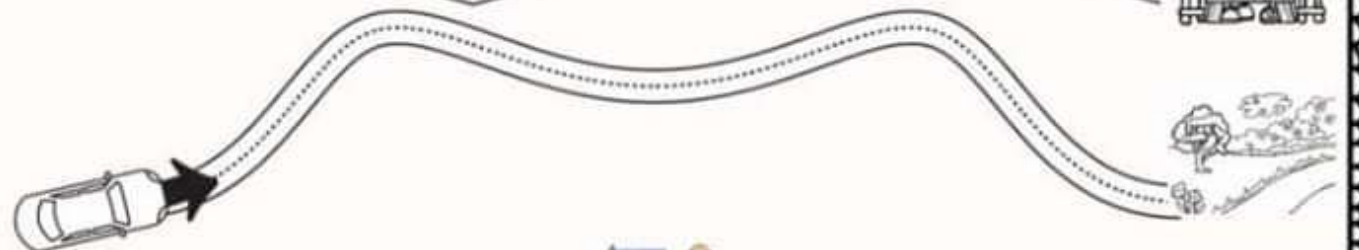
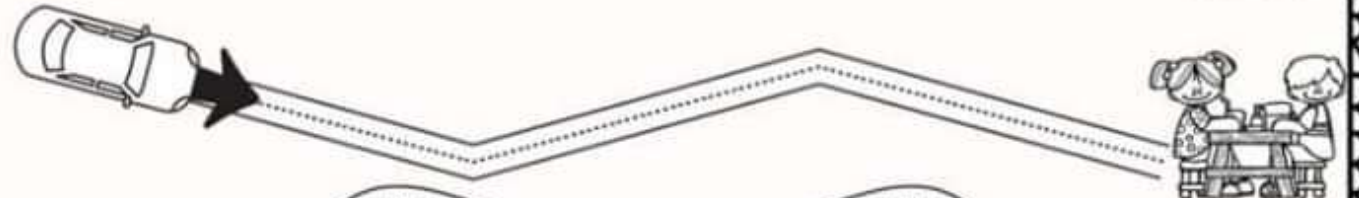
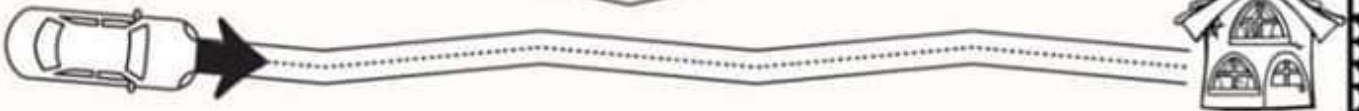
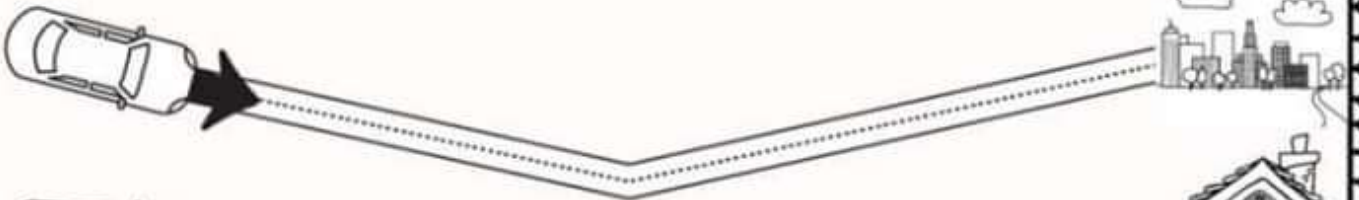

Repasa

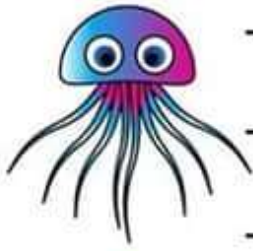

Repasa





Repasa

Grafomotricidad

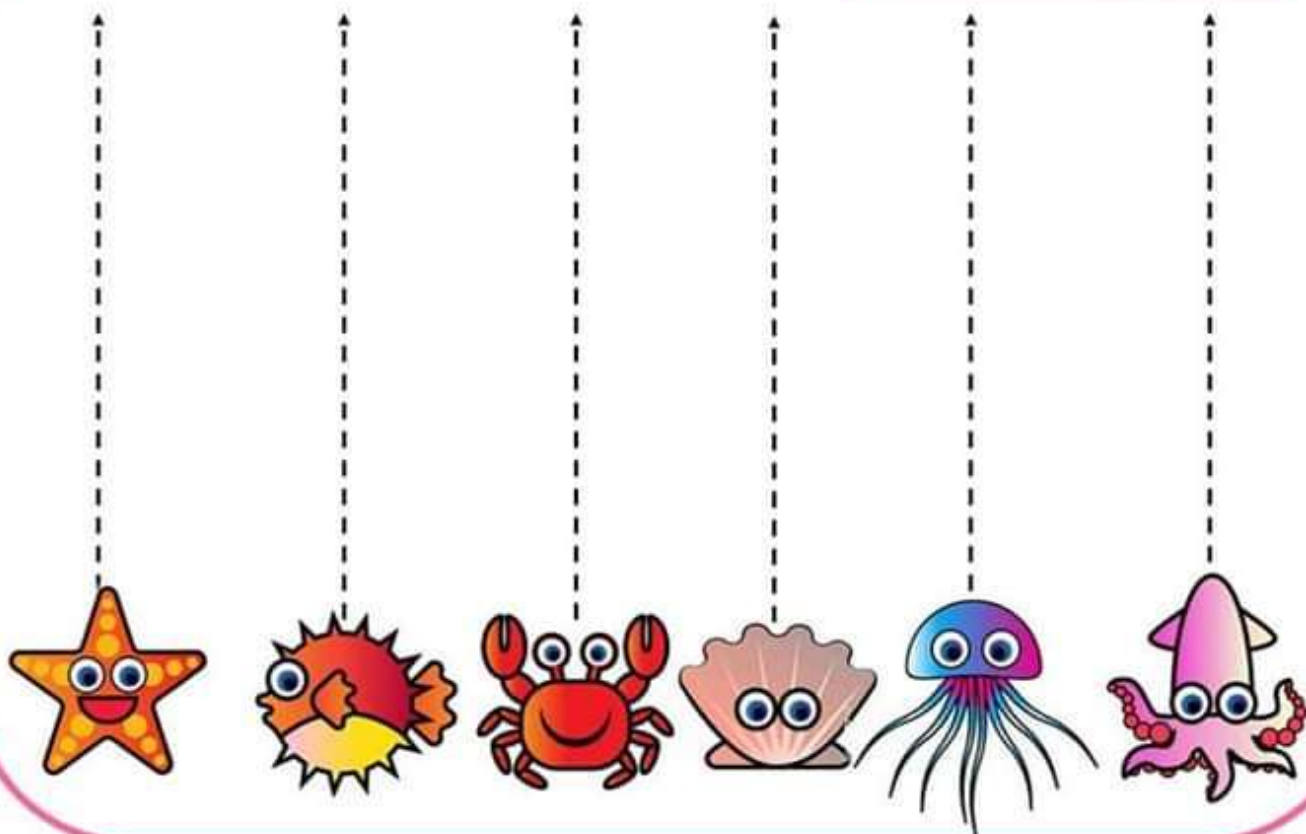

Repasa

Grafomotricidad

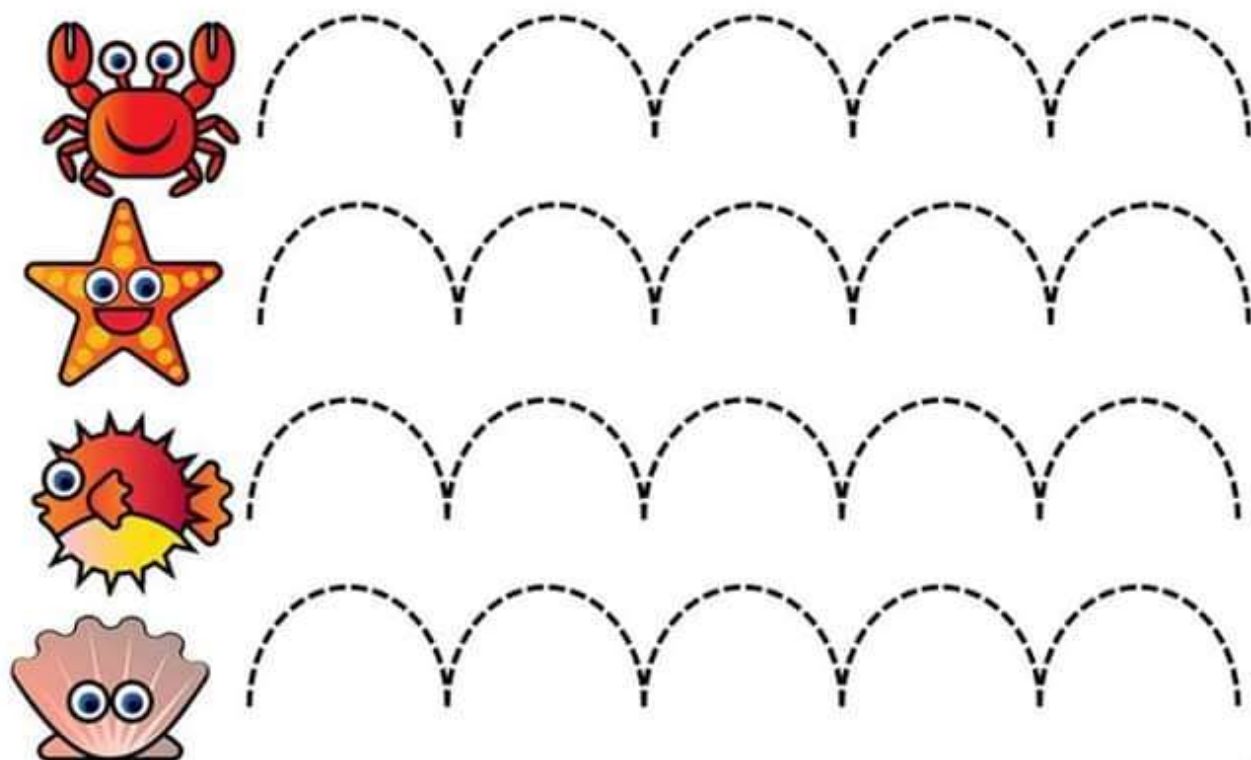

# Repasa

Grafomotricidad

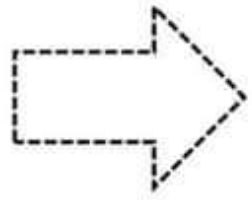
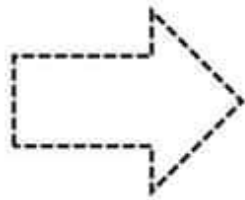
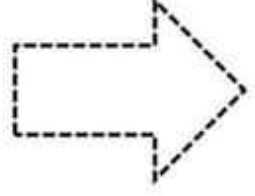
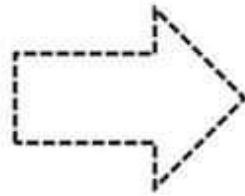
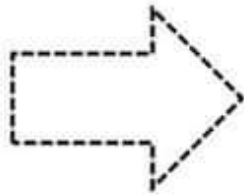
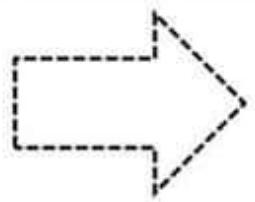
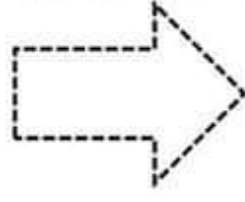
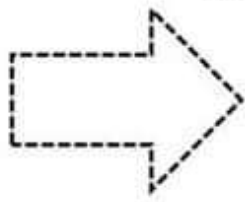

## Repasa las líneas

Nombre: \_\_\_\_\_ Fecha: \_\_\_\_\_

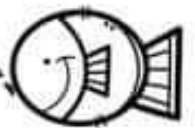

# Repasa las líneas

Nombre: \_\_\_\_\_ Fecha: \_\_\_\_\_

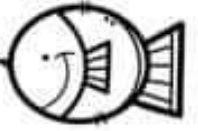

Pag. 5

# Repasa las líneas

Nombre: \_\_\_\_\_ Fecha: \_\_\_\_\_

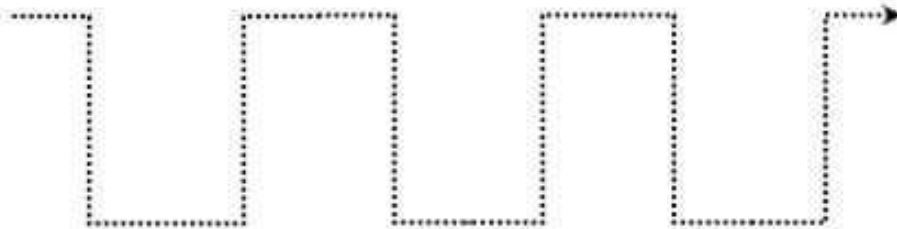

Pag. 4

# Repasa las líneas

Nombre: \_\_\_\_\_ Fecha: \_\_\_\_\_

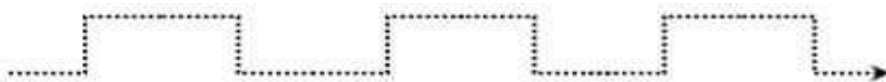

Pag. 4

# Repasa las líneas

Nombre: \_\_\_\_\_ Fecha: \_\_\_\_\_

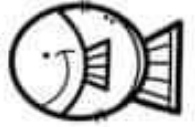



Realiza el trazo con cuidado

Realiza el trazo con cuidado

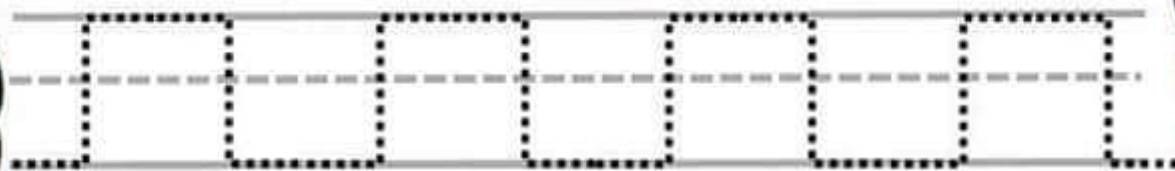
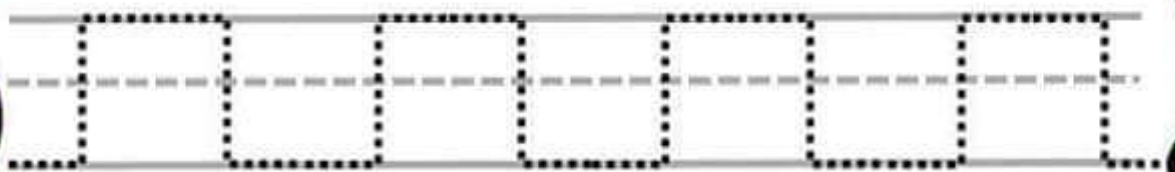
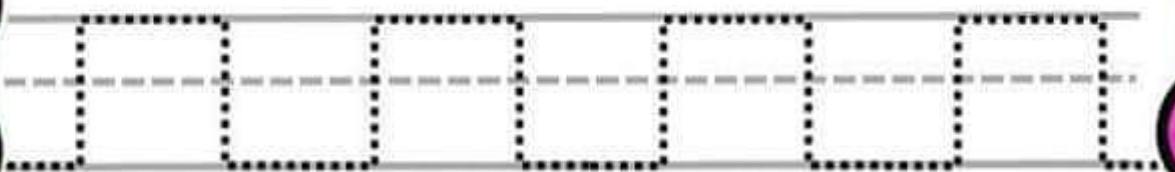
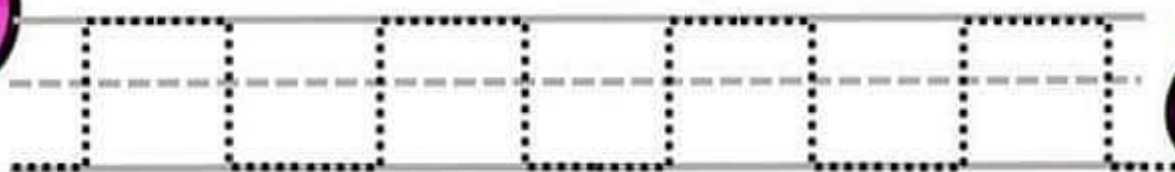
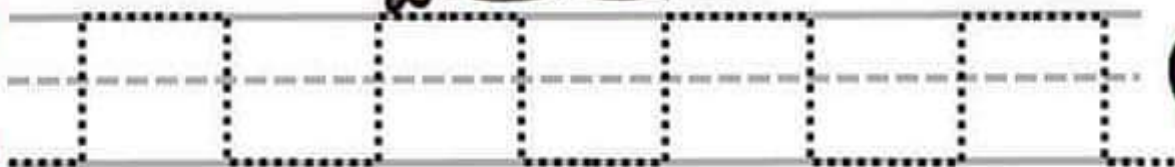



Realiza el trazo con cuidado

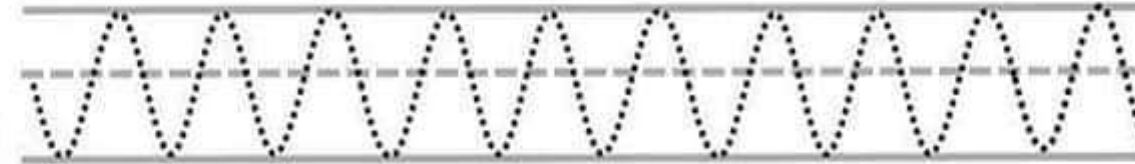
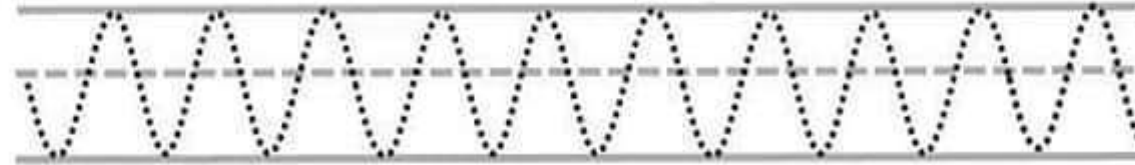
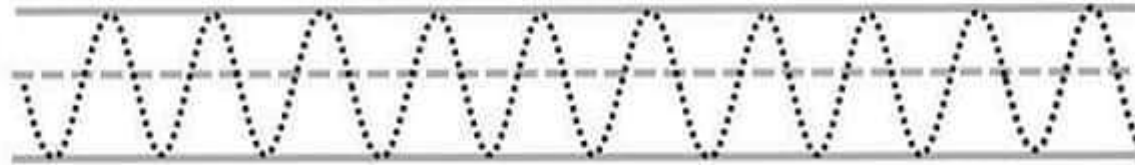
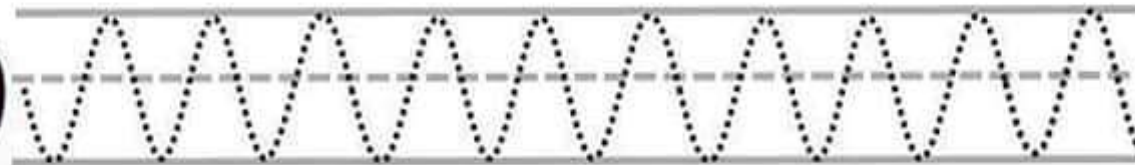
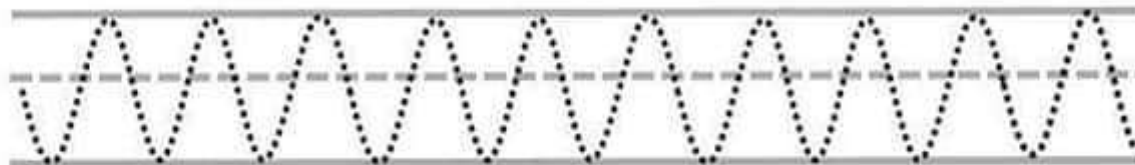
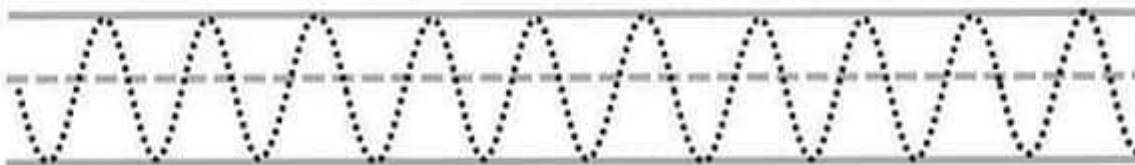
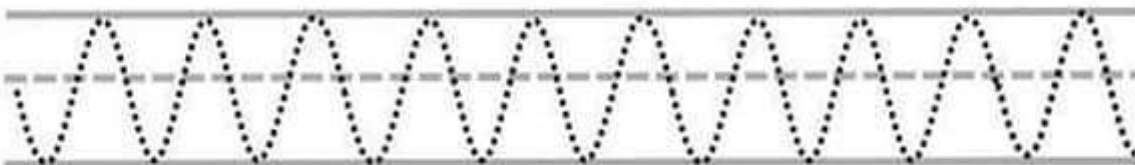



Realiza el trazo con cuidado

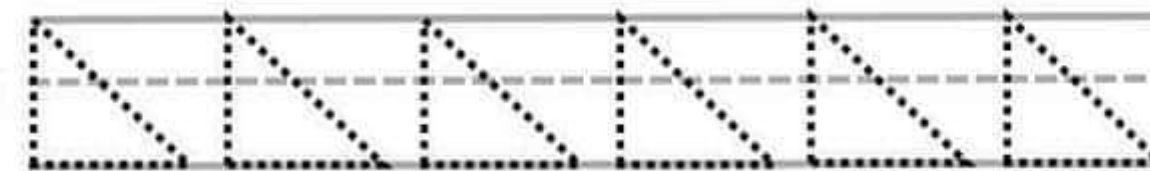
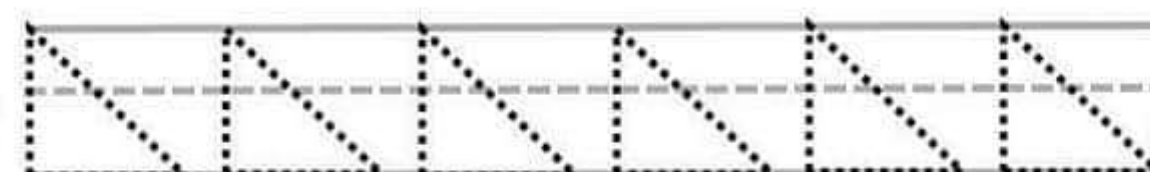
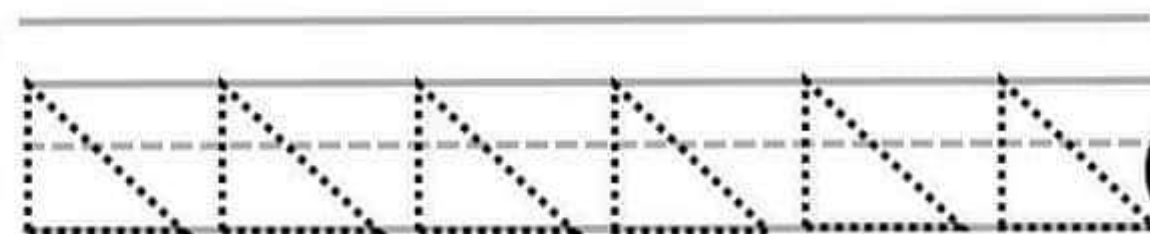
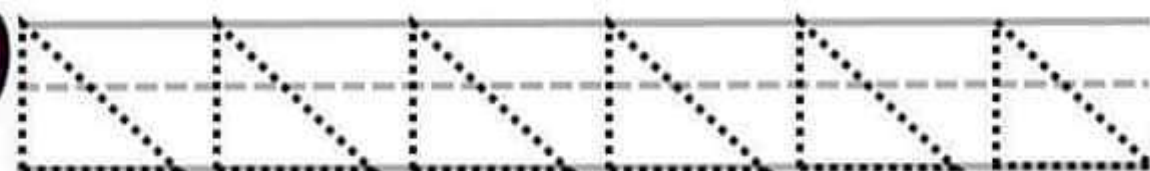
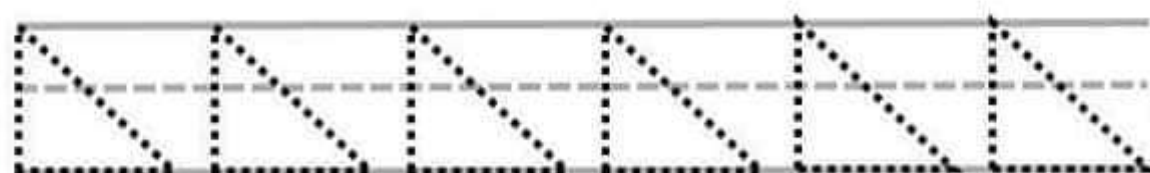
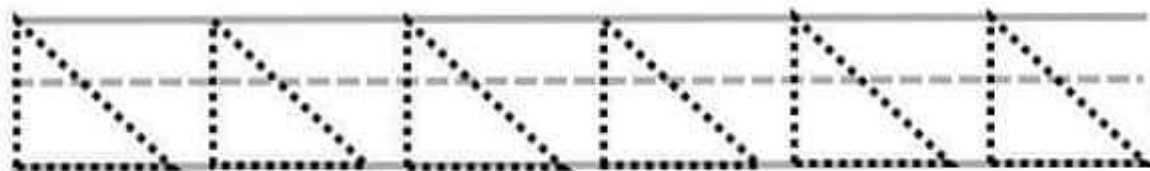
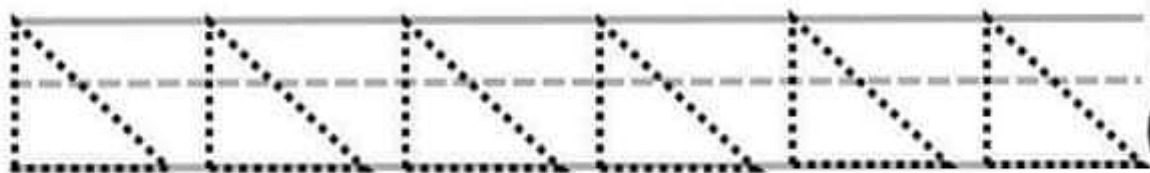



Realiza el trazo con cuidado

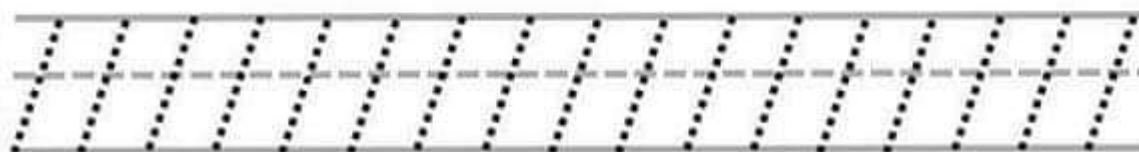
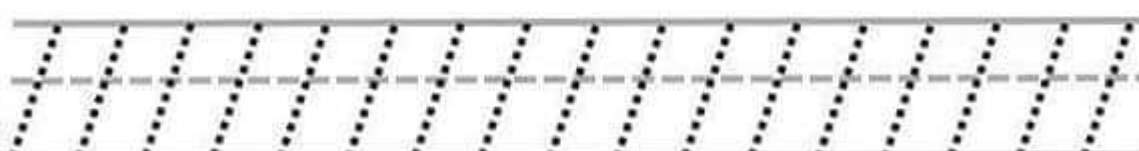
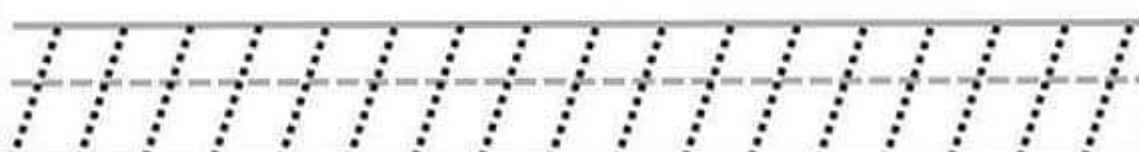
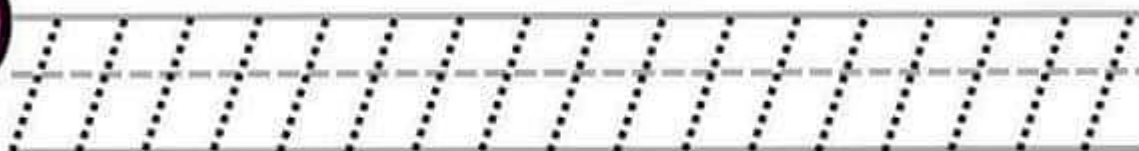
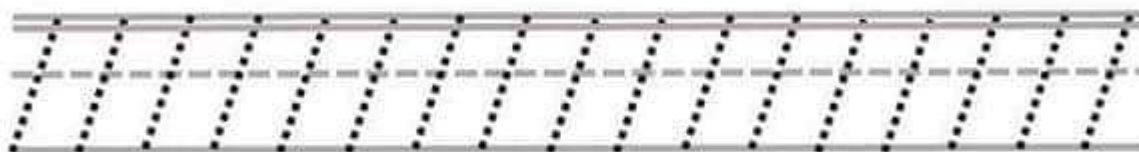
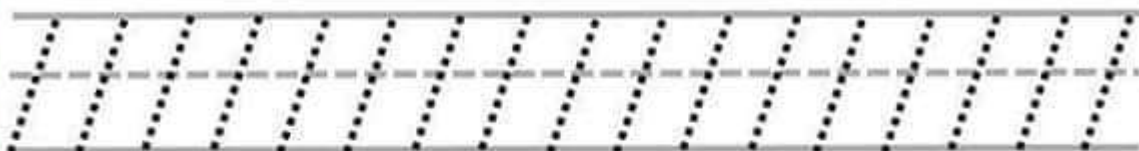
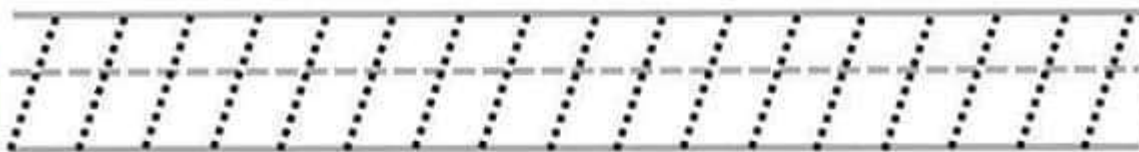





Realiza el trazo con cuidado

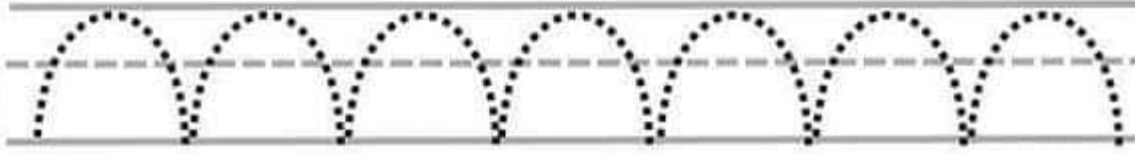
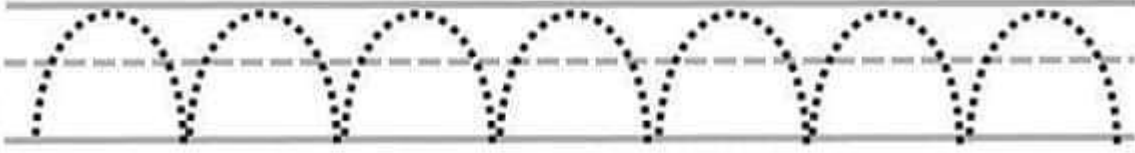
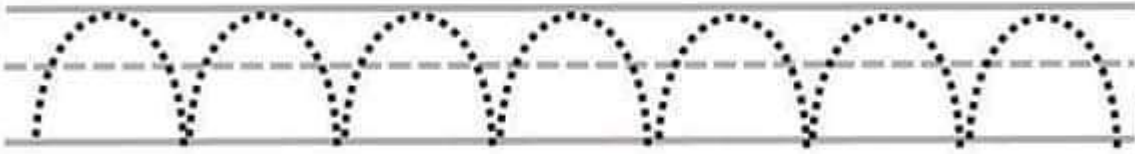
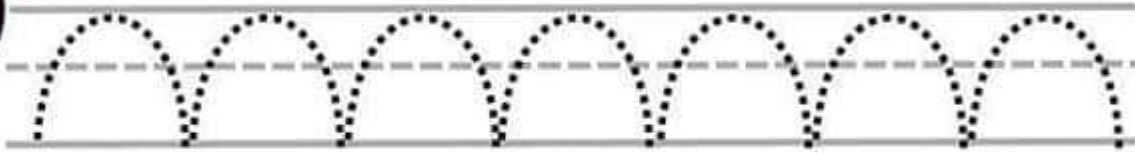
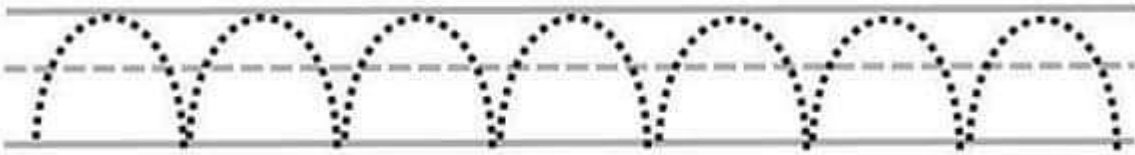
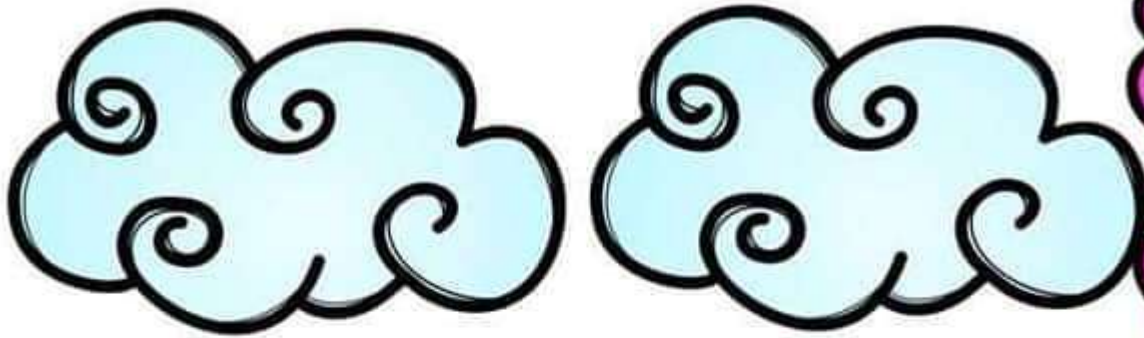



Realiza el trazo con cuidado

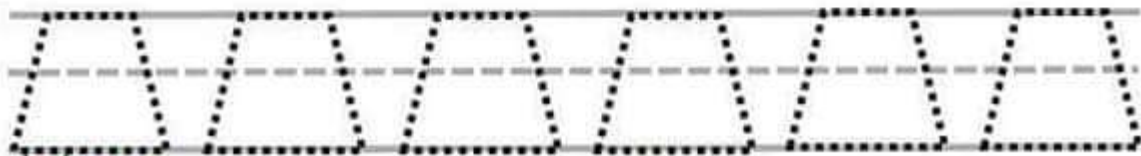
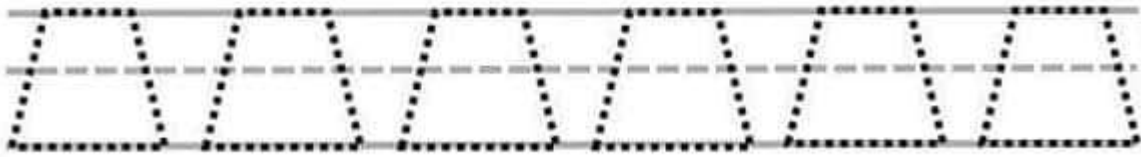
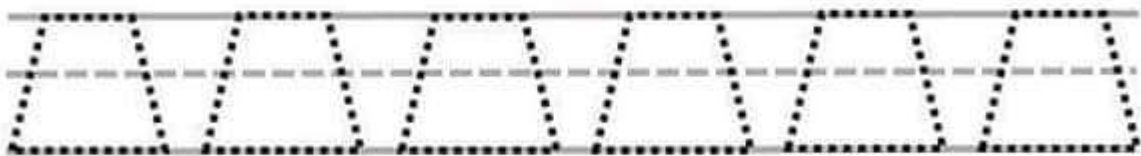
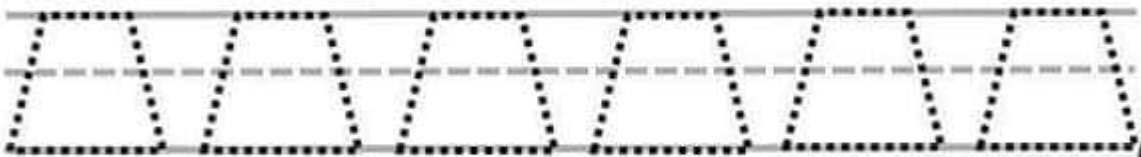
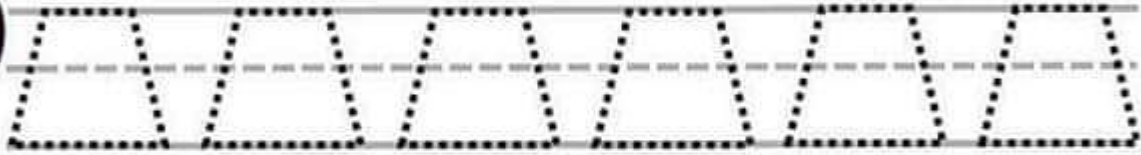
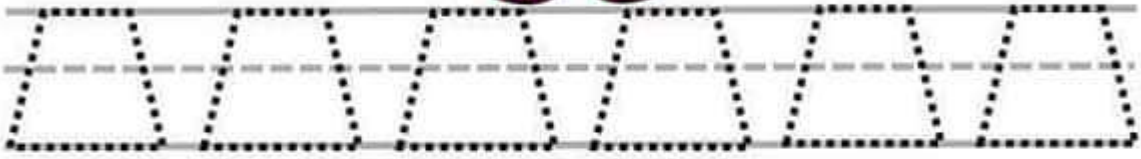



Realiza el trazo con cuidado

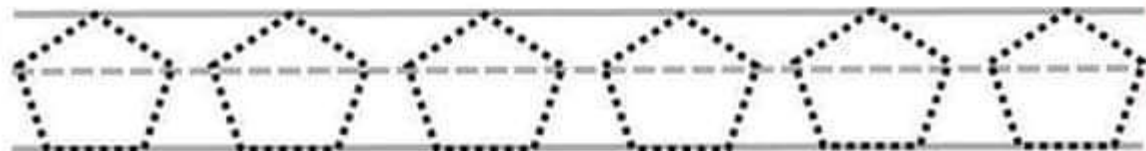
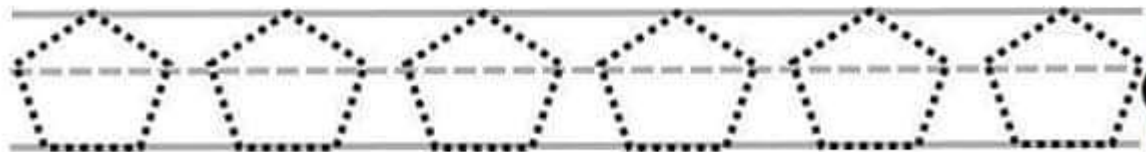
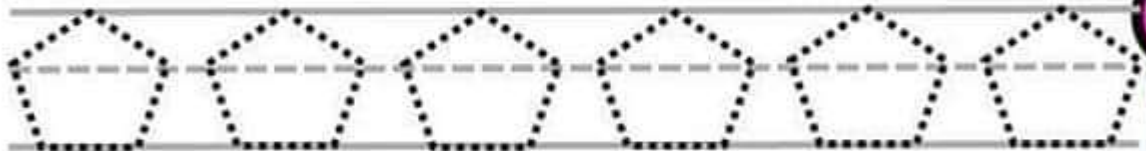
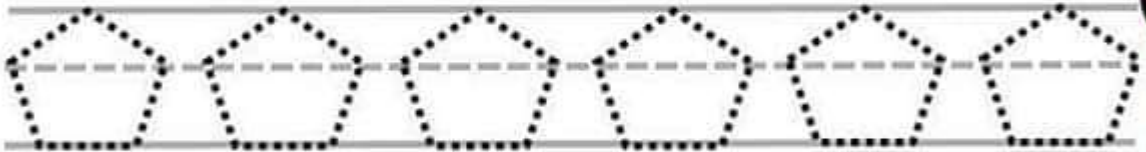
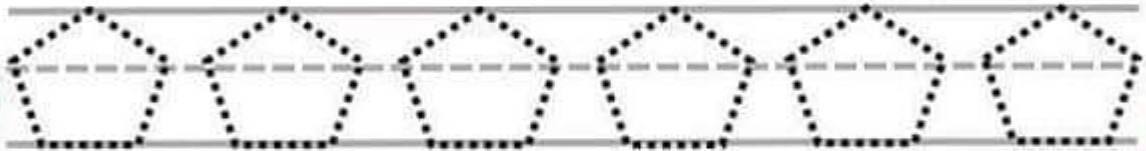
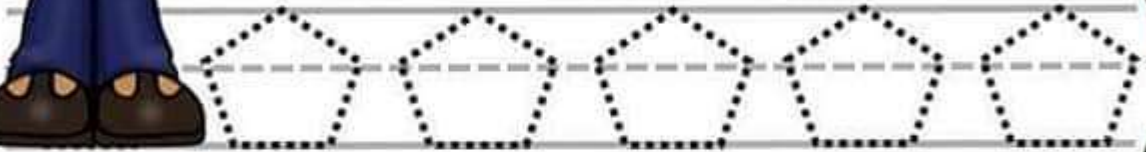
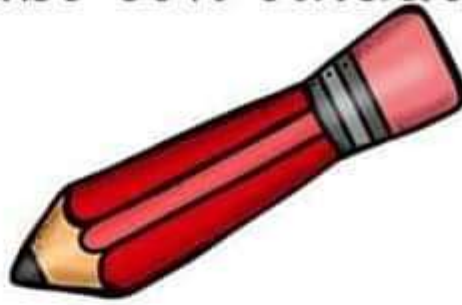



Realiza el trazo con cuidado

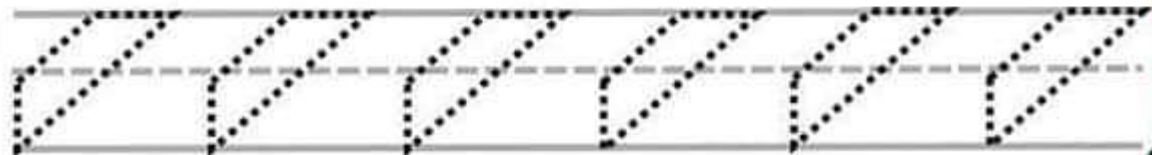
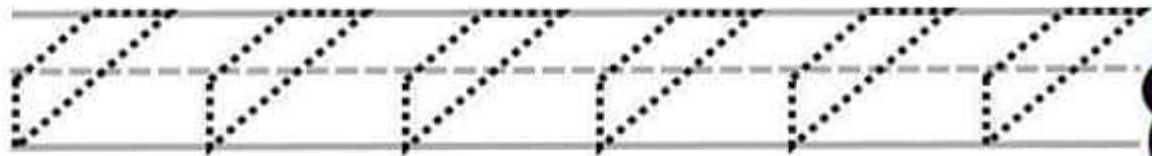
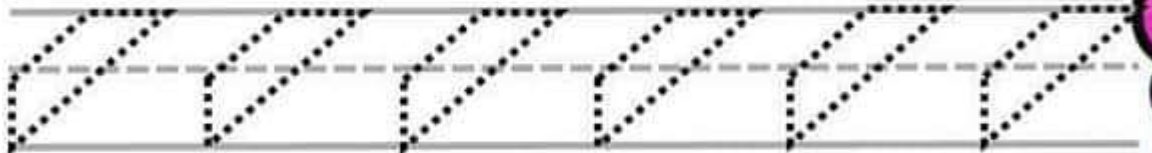
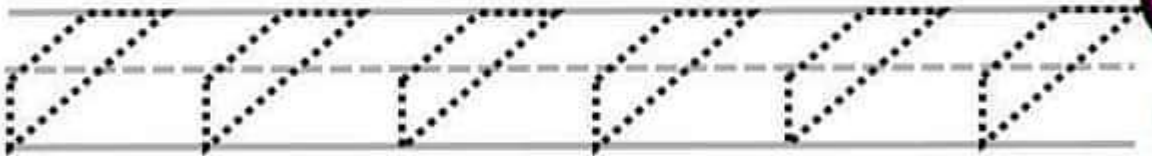
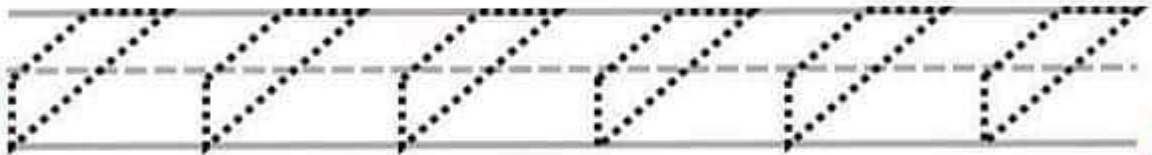
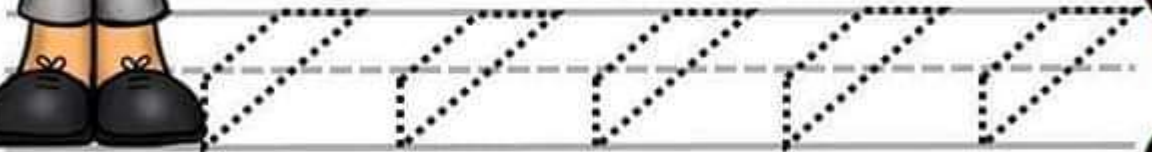



Realiza el trazo con cuidado

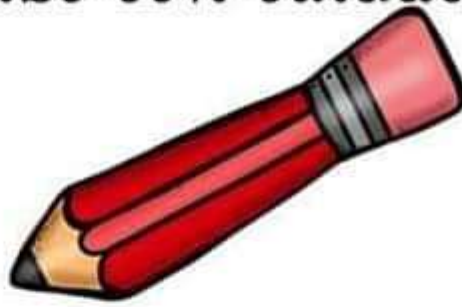

Tracing practice area consisting of six rows of dotted circles on a three-line grid. Each row contains six circles. The first row is partially filled by the boy's pencil.



Realiza el trazo con cuidado

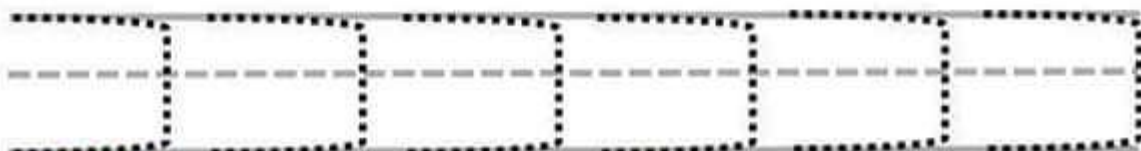
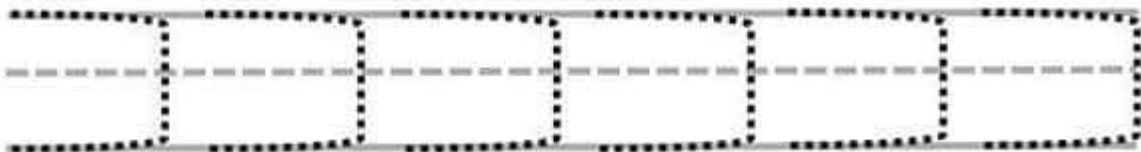
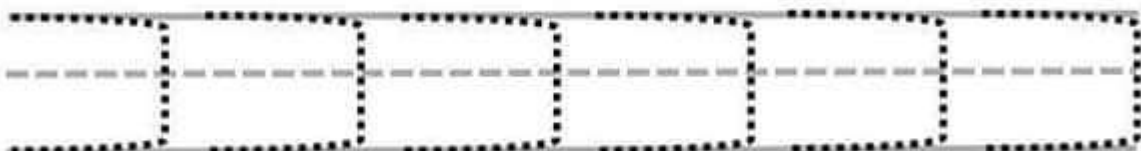
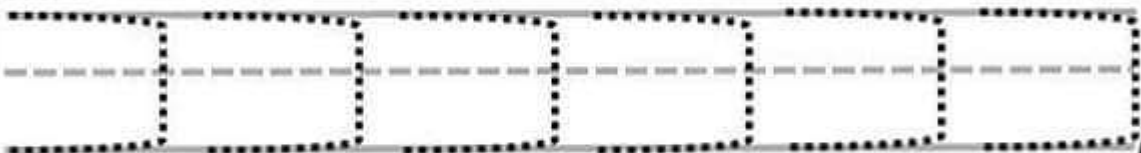
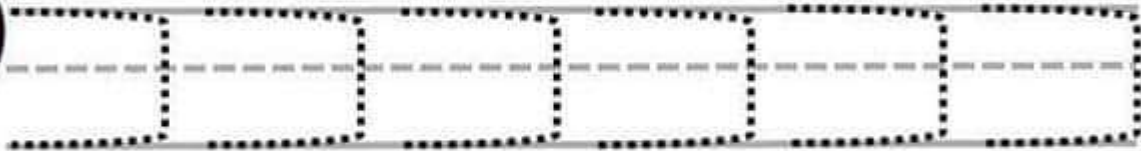
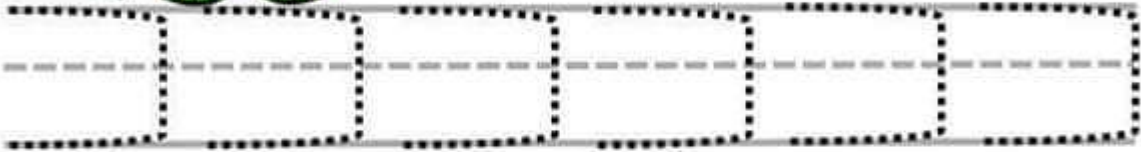
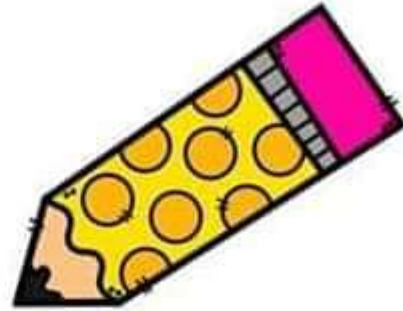



Realiza el trazo con cuidado

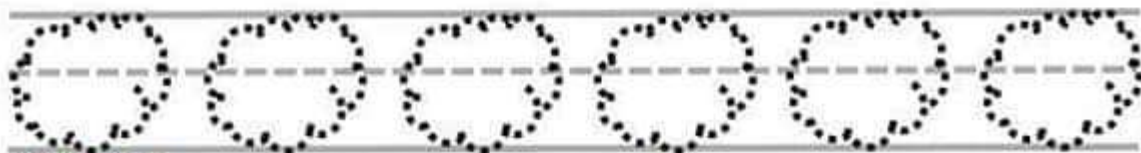
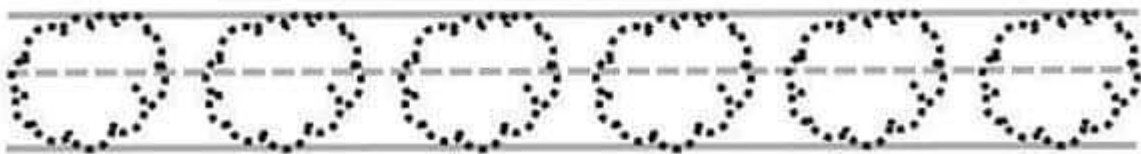
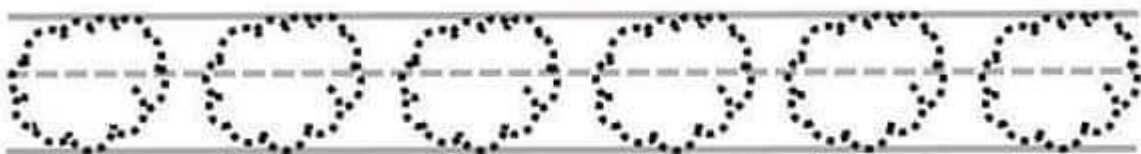
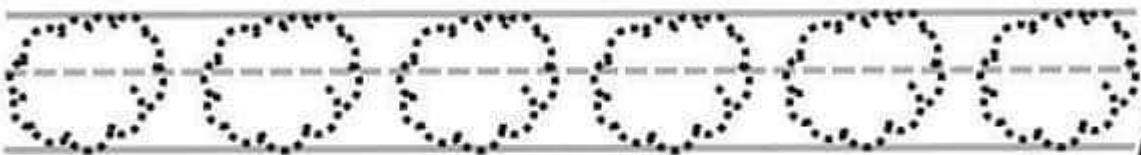
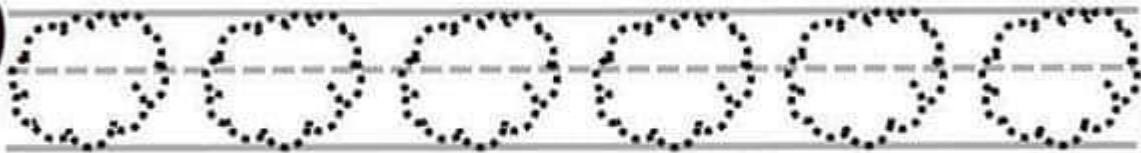
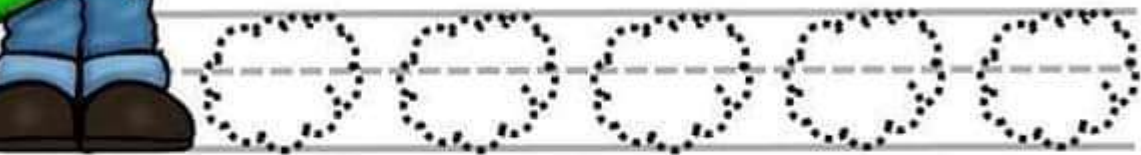



Realiza el trazo con cuidado

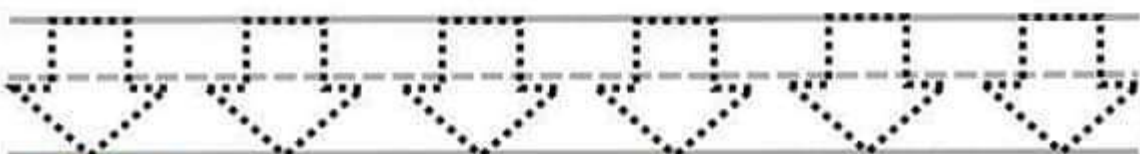
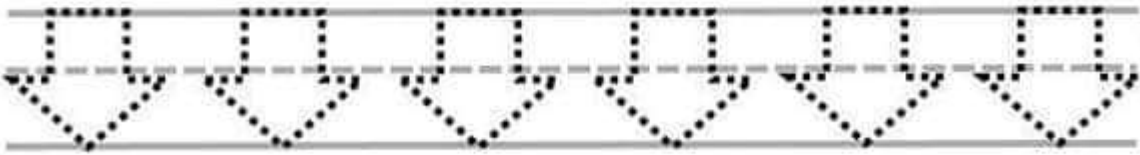
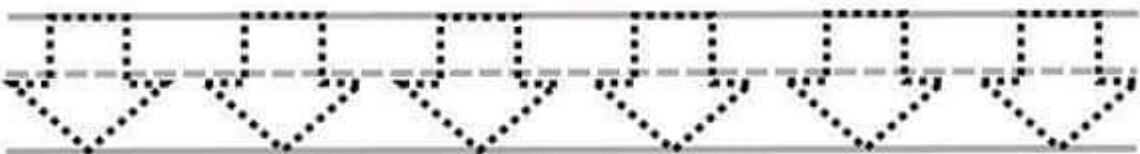
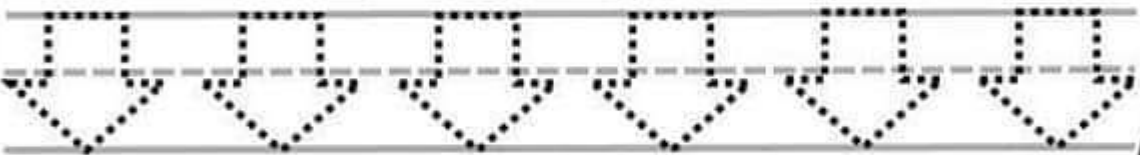
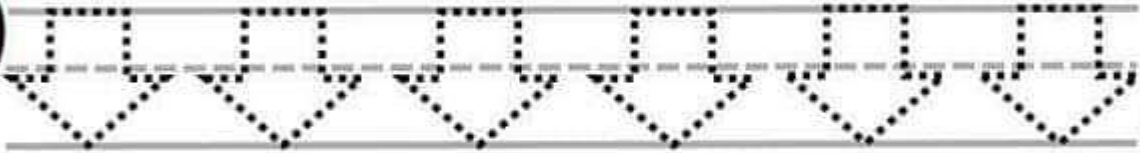
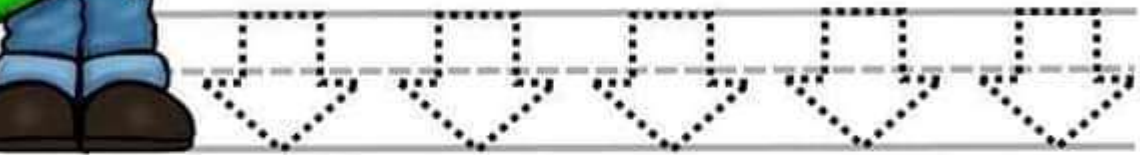
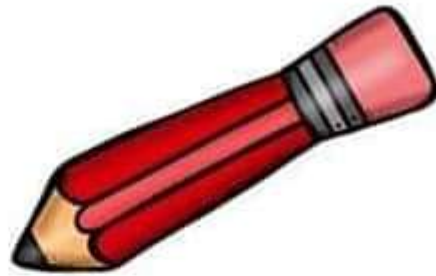





Realiza el trazo con cuidado

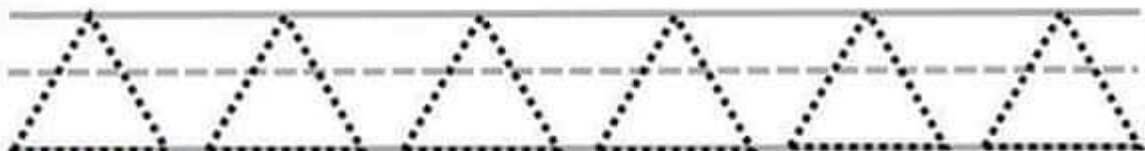
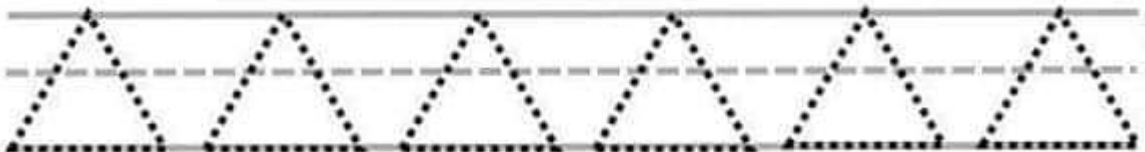
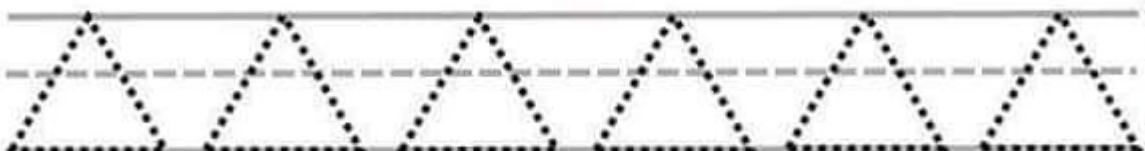
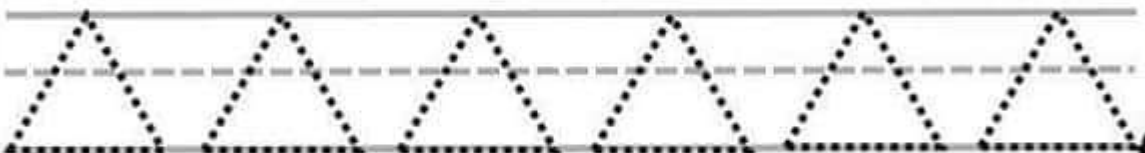
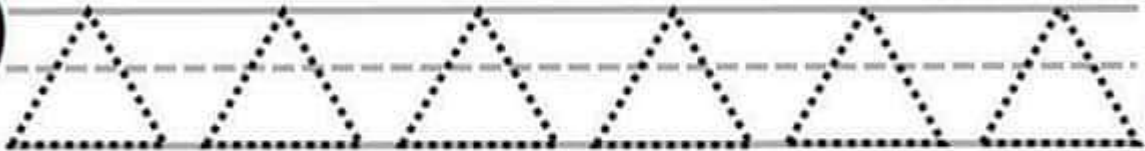
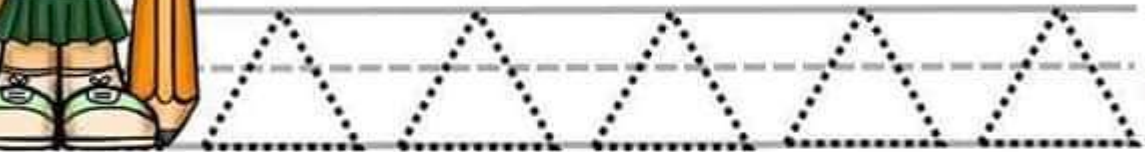



Realiza el trazo con cuidado

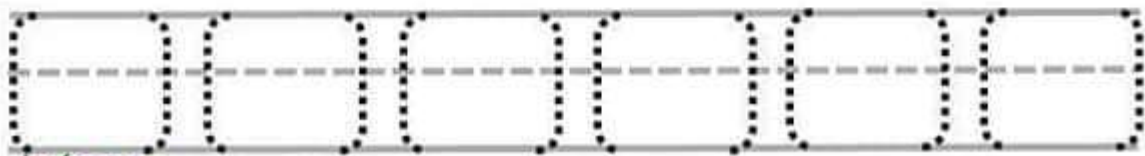
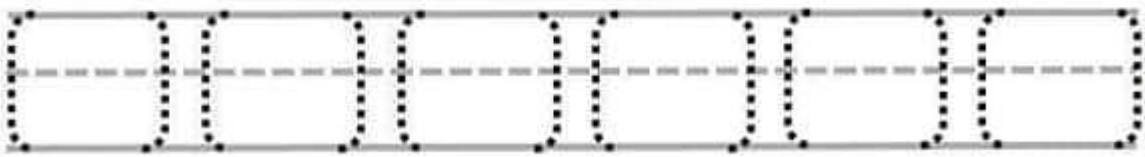
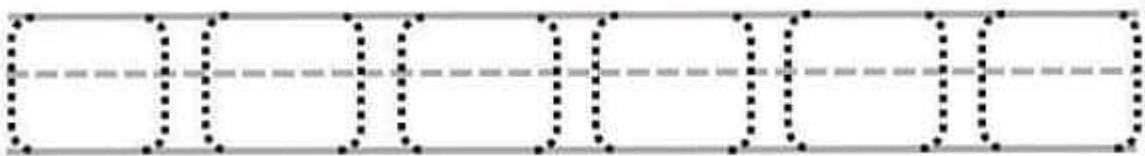
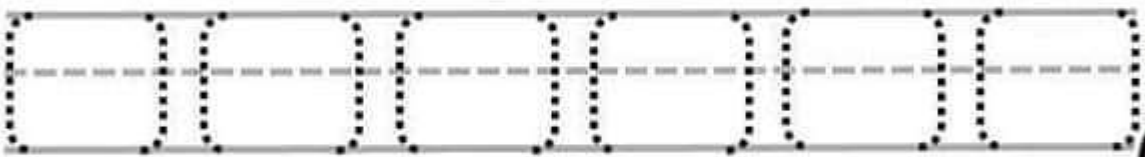
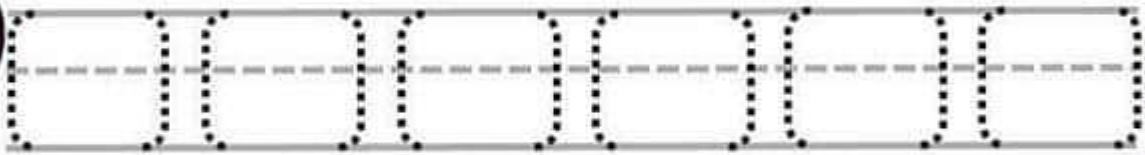
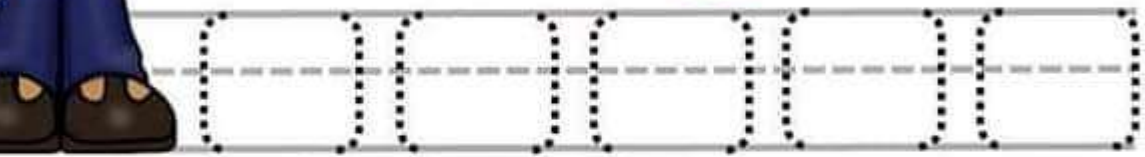

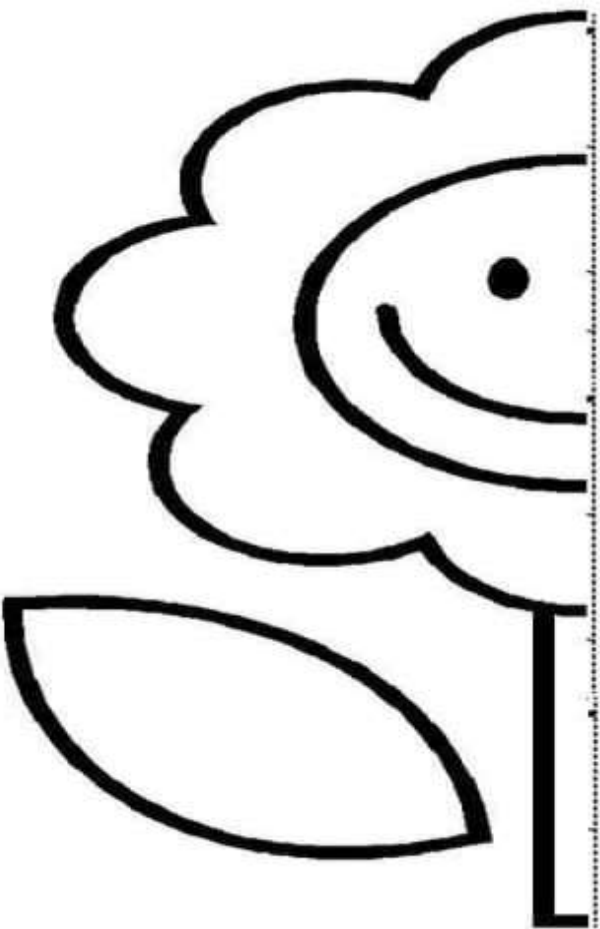
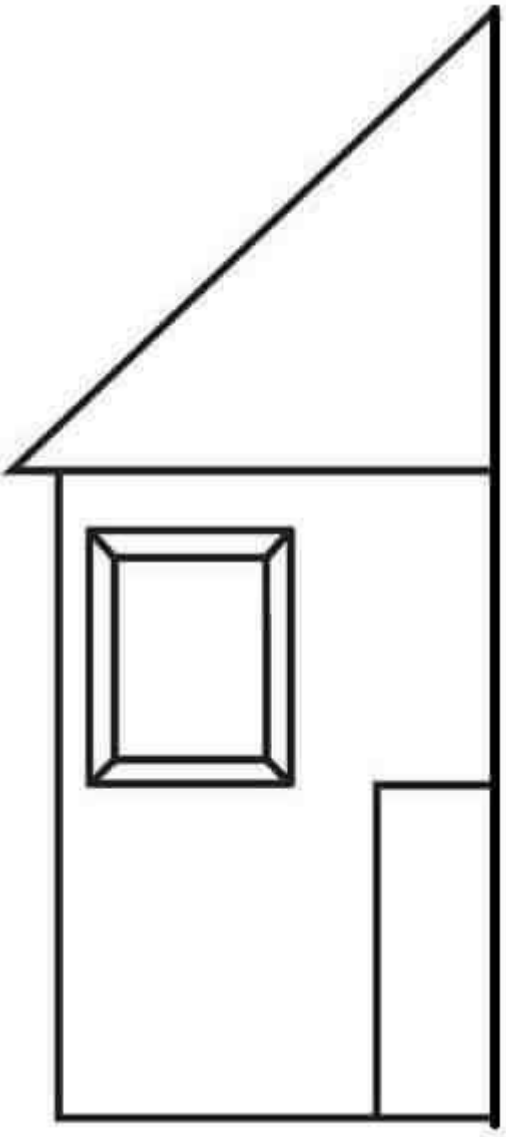

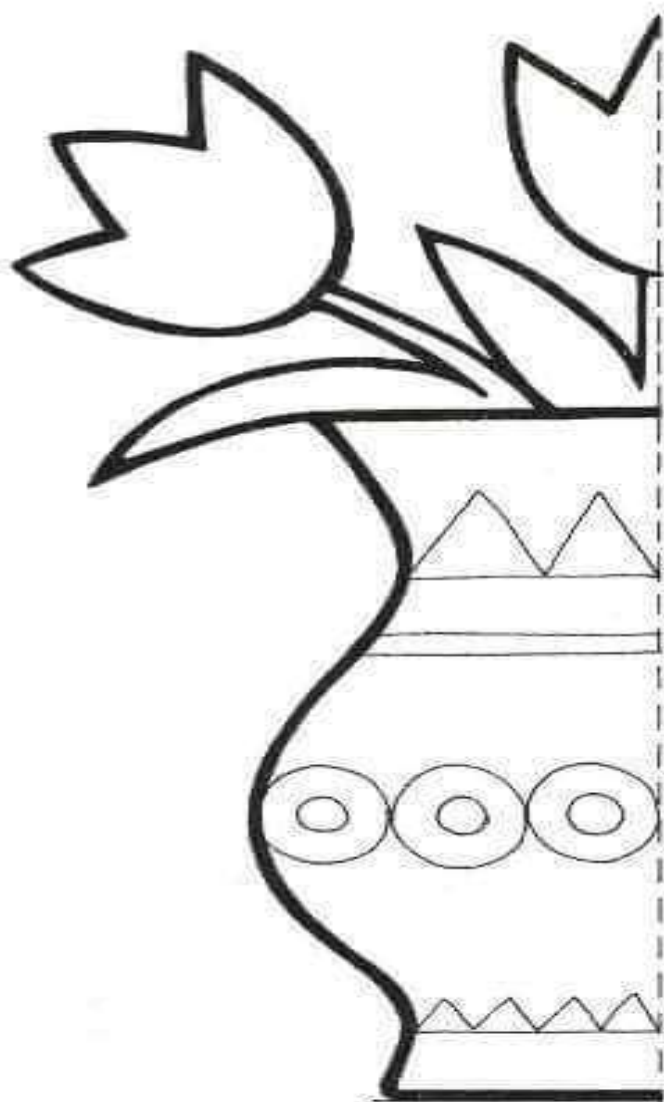
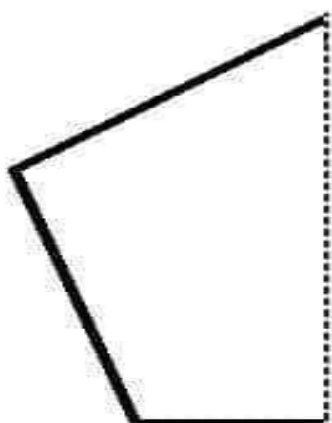
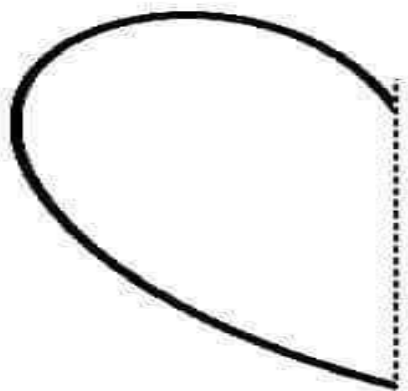

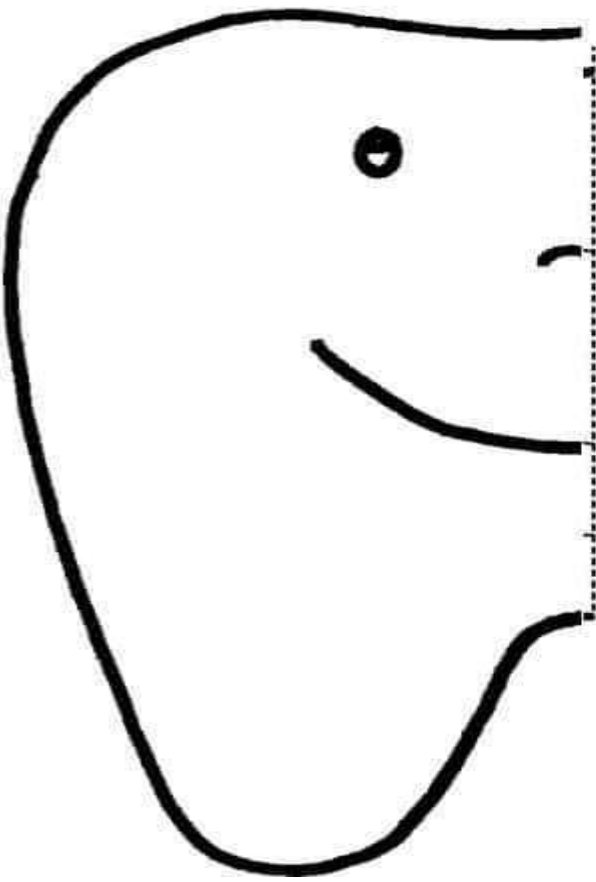
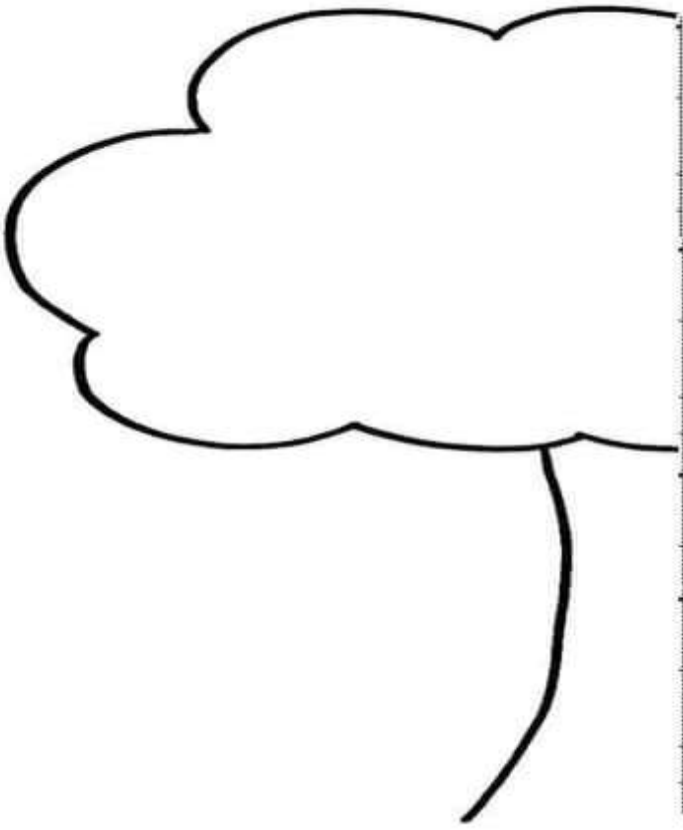

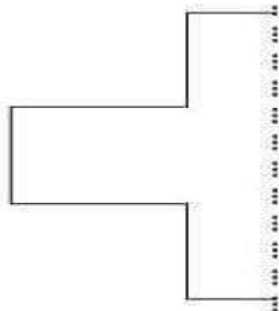
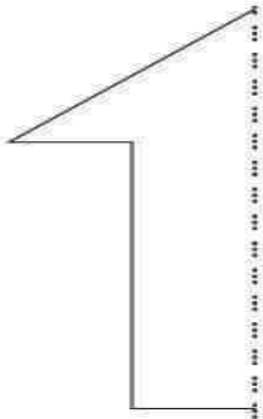
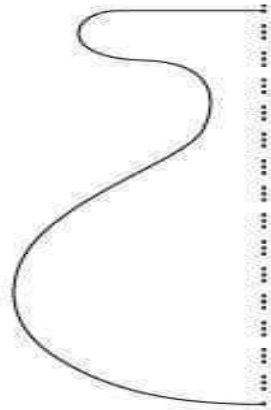
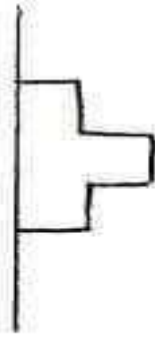

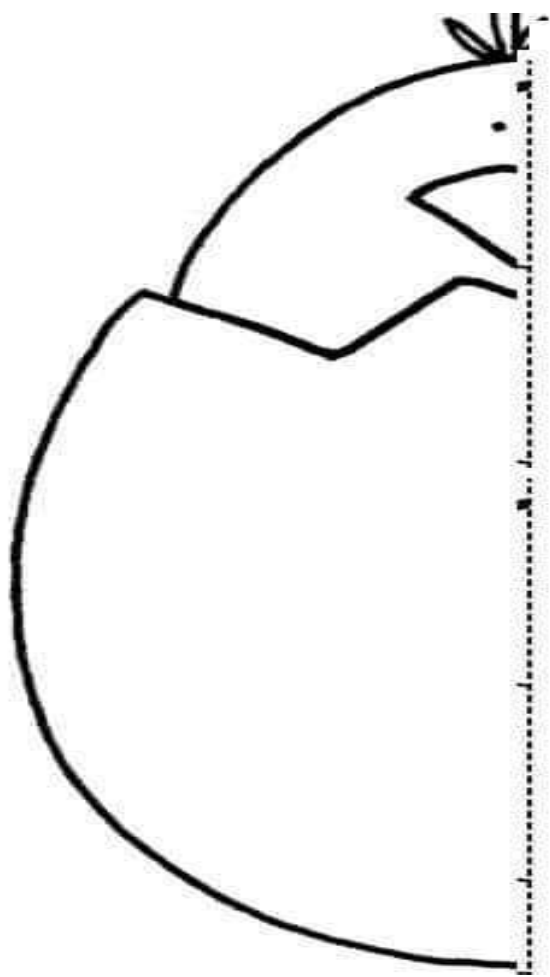
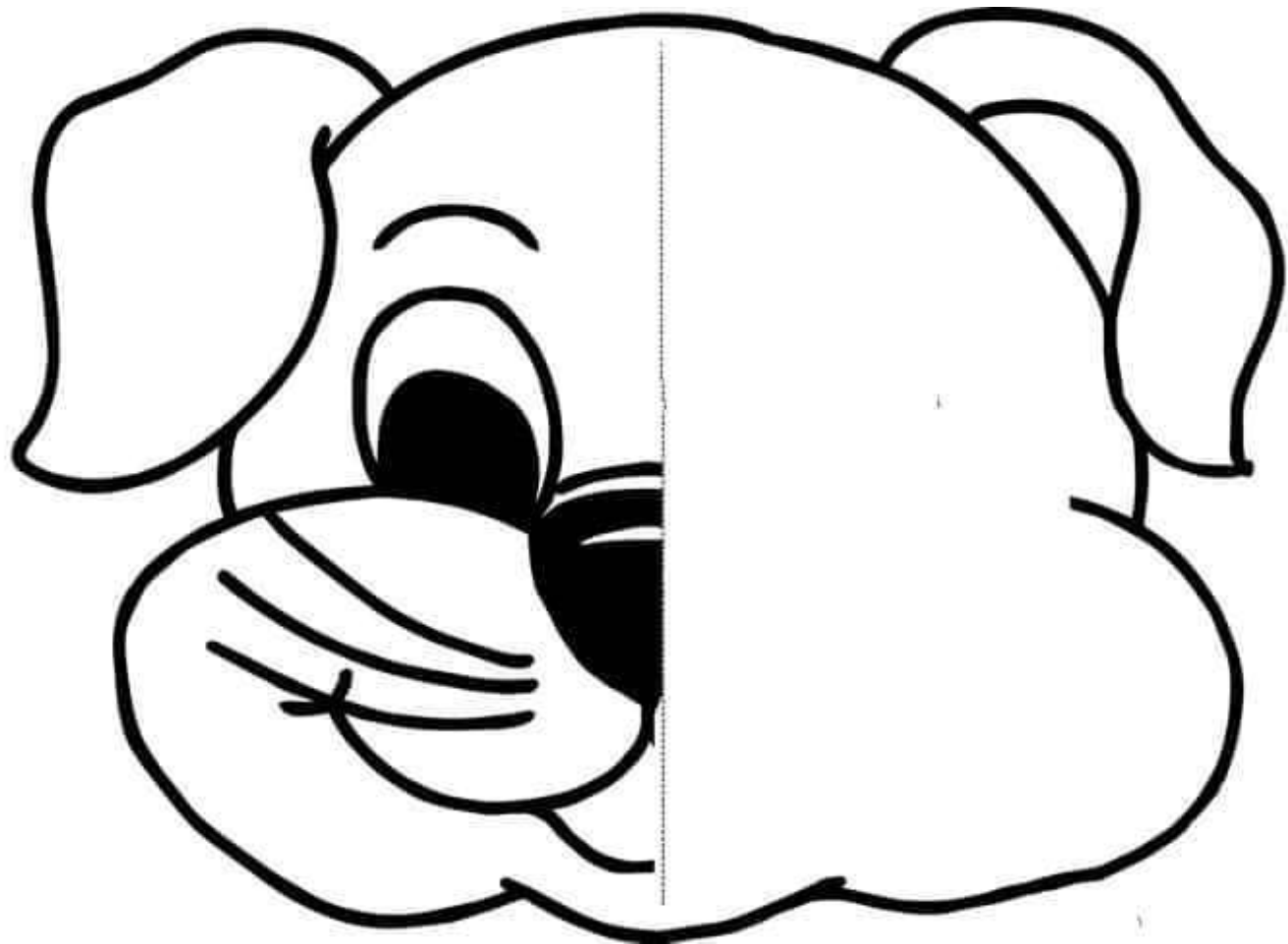

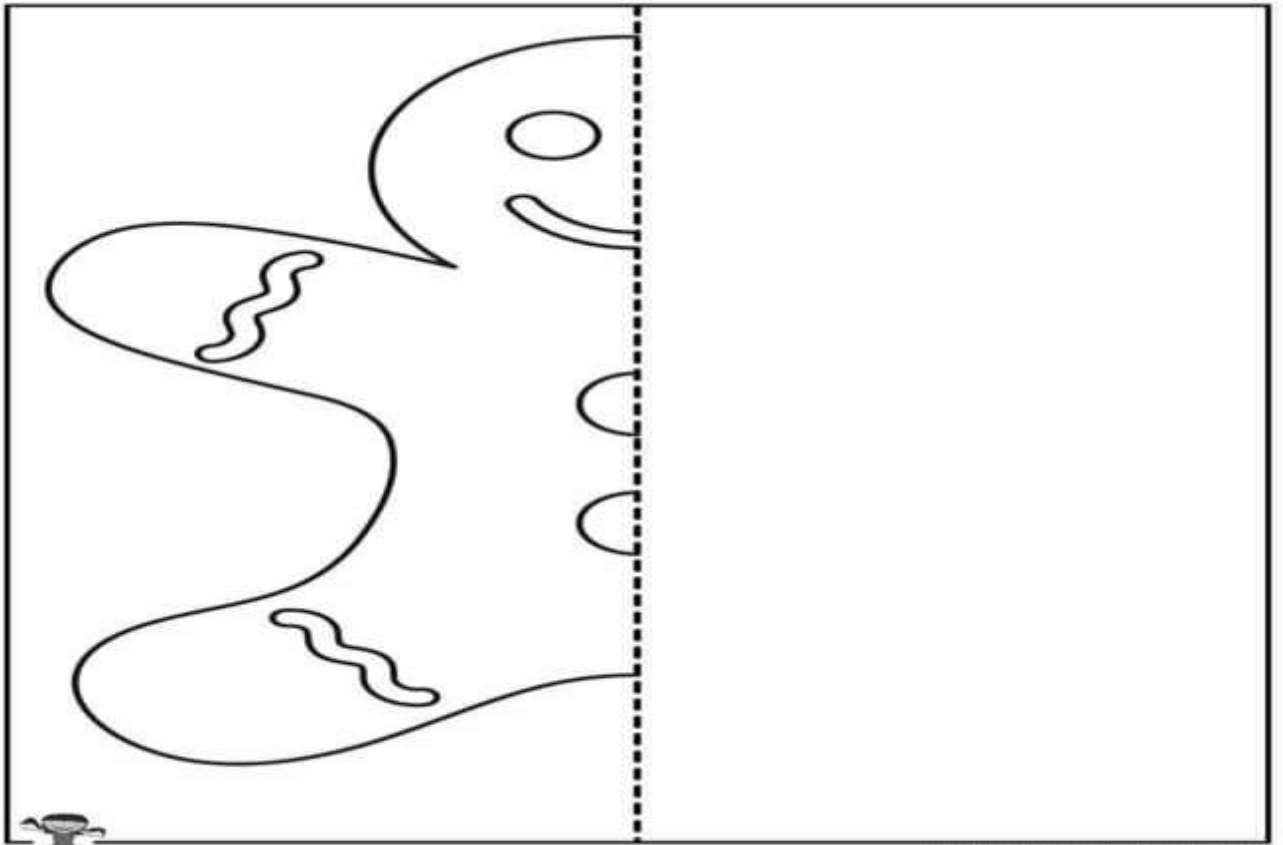
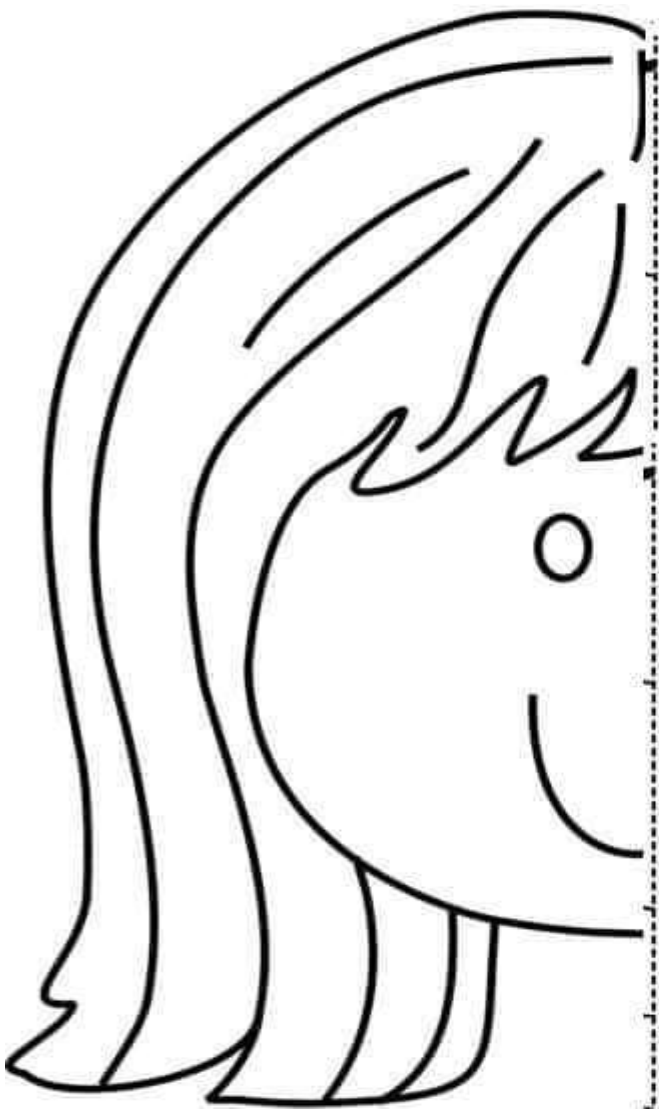



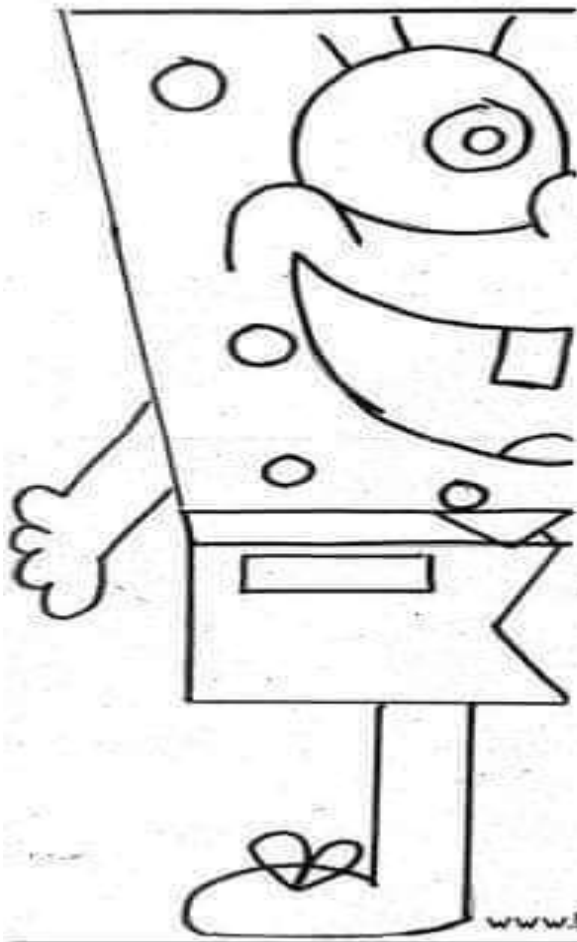

[www.lessonplansos.blogspot.com](http://www.lessonplansos.blogspot.com)

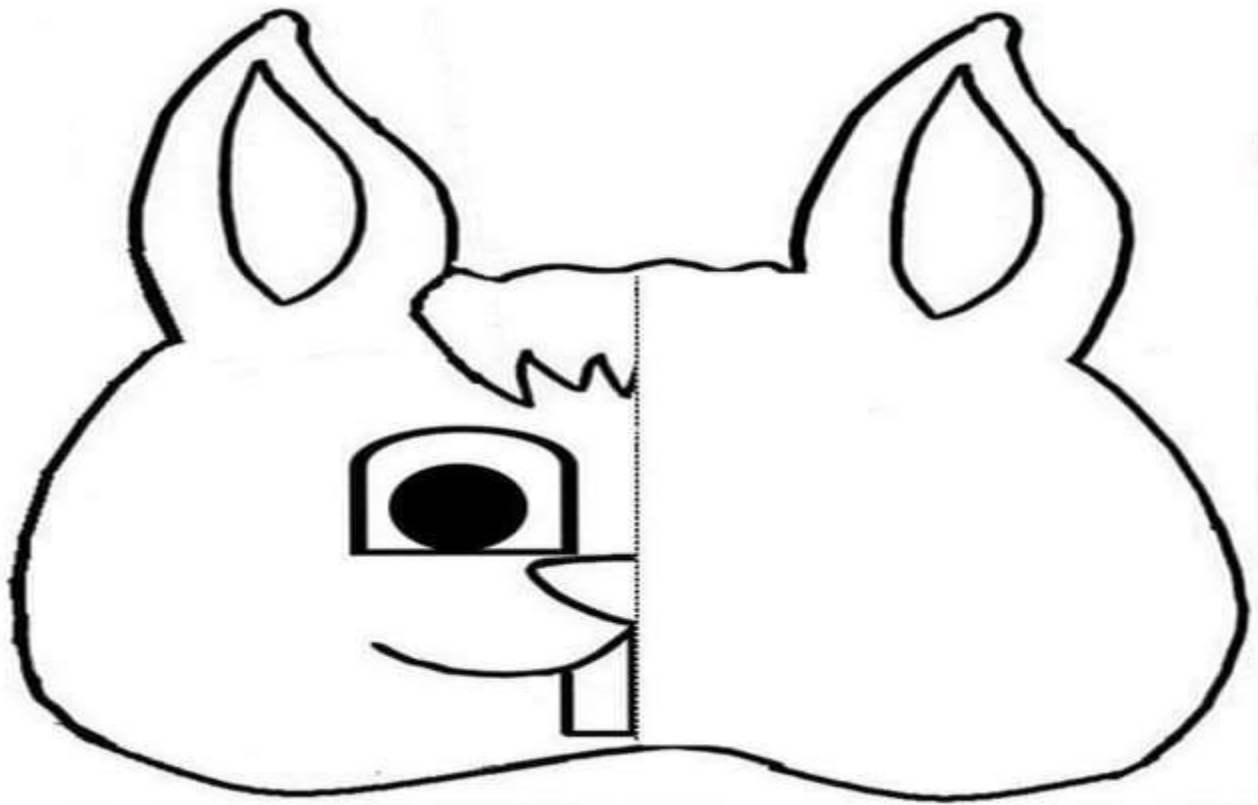

# Gingerbread Man Symmetry

Complete the gingerbread man.

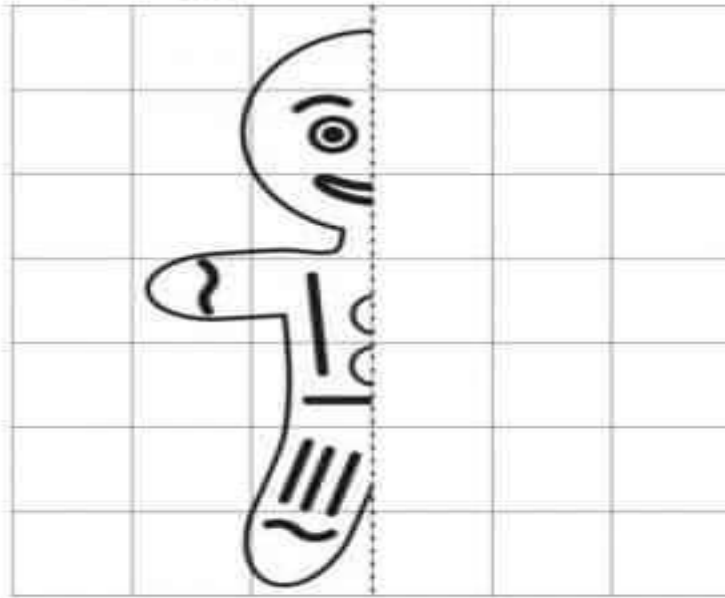

© www.ActivityVillage.co.uk - Keeping Kids Busy

Activity  
village

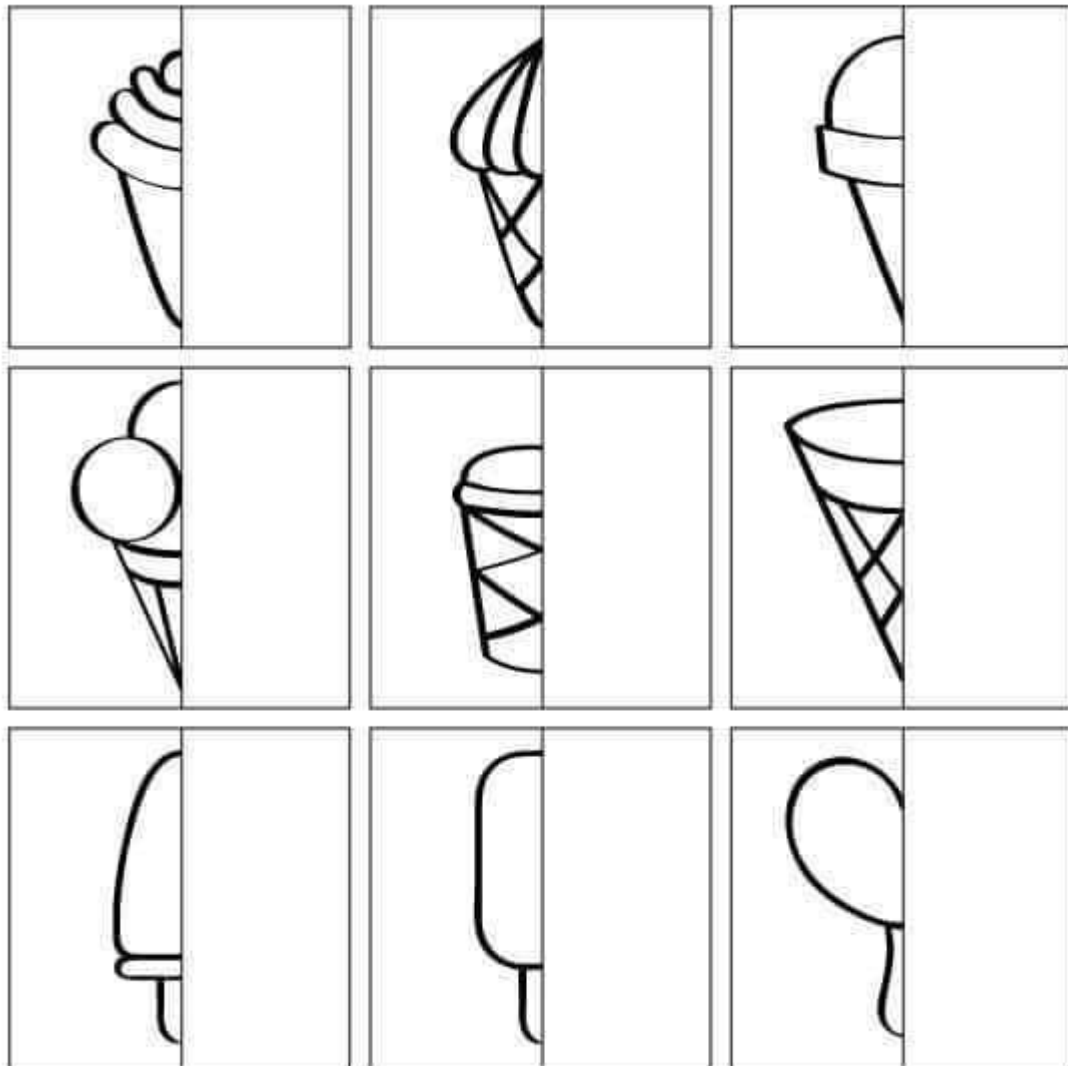

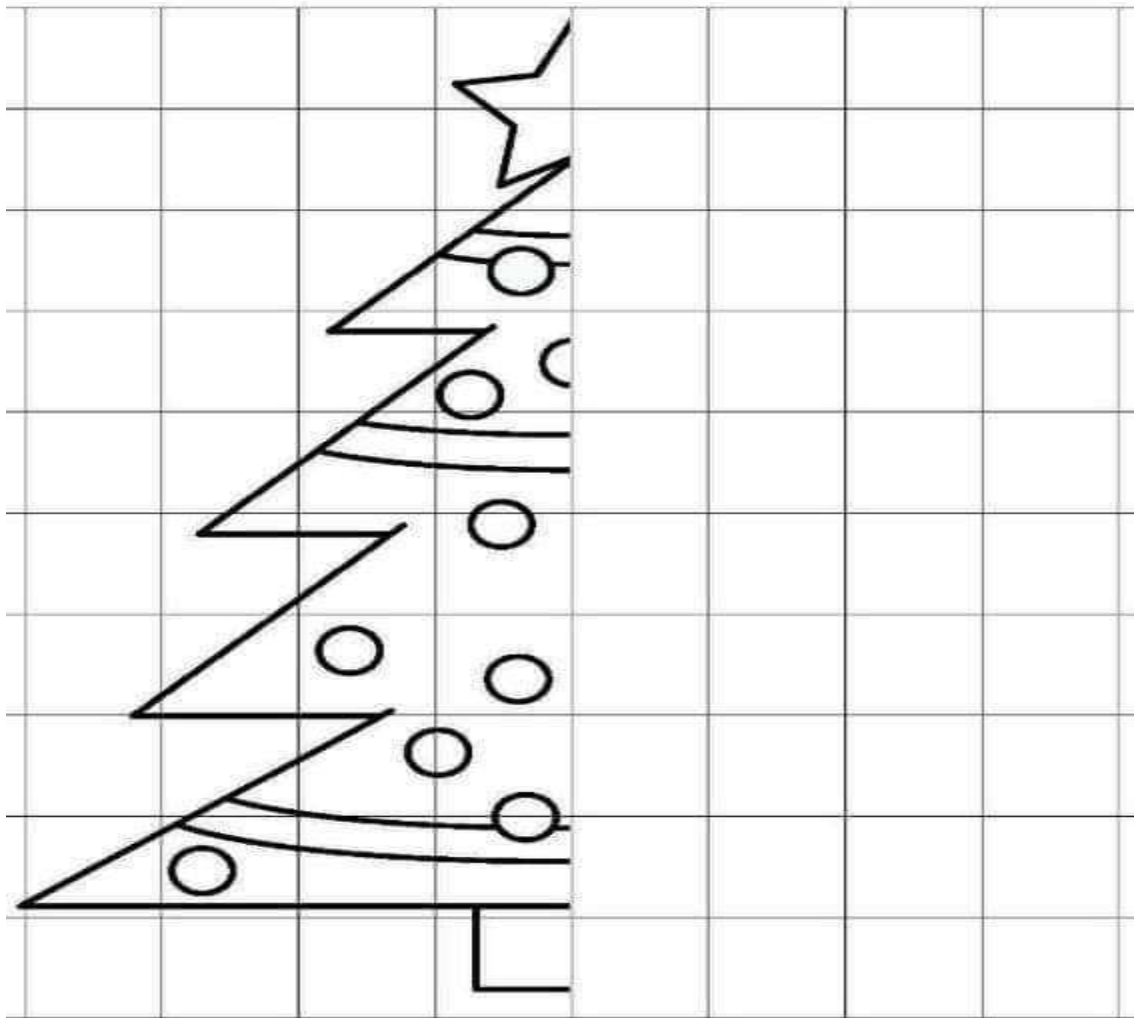

Name \_\_\_\_\_

Date \_\_\_\_\_

**Practice in Symmetry:** Use the grid below to draw a mirror image of the frog's left side on the blank side of the axis.

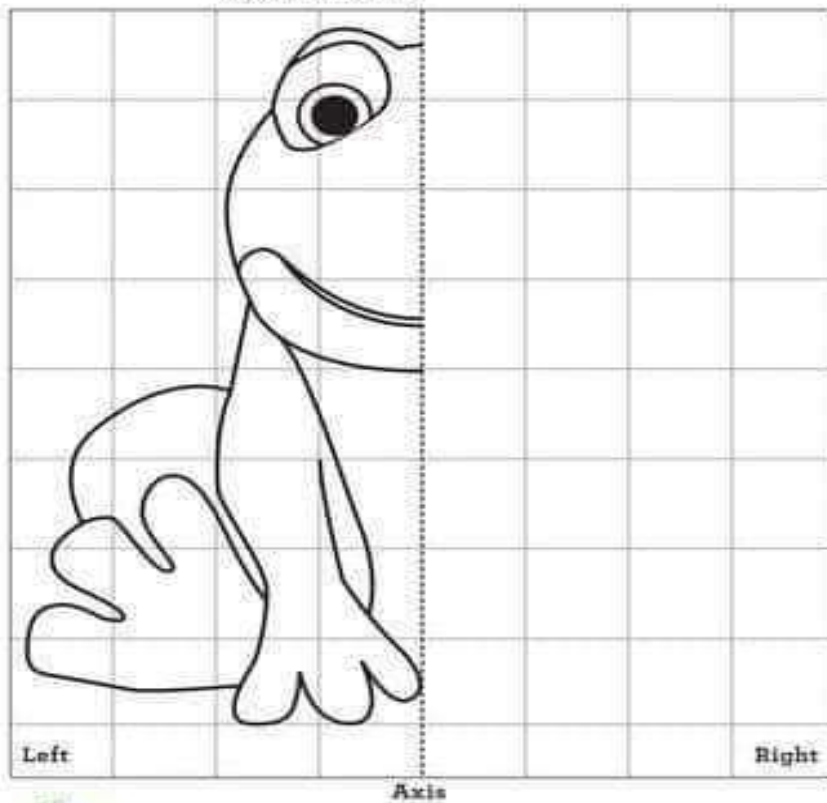

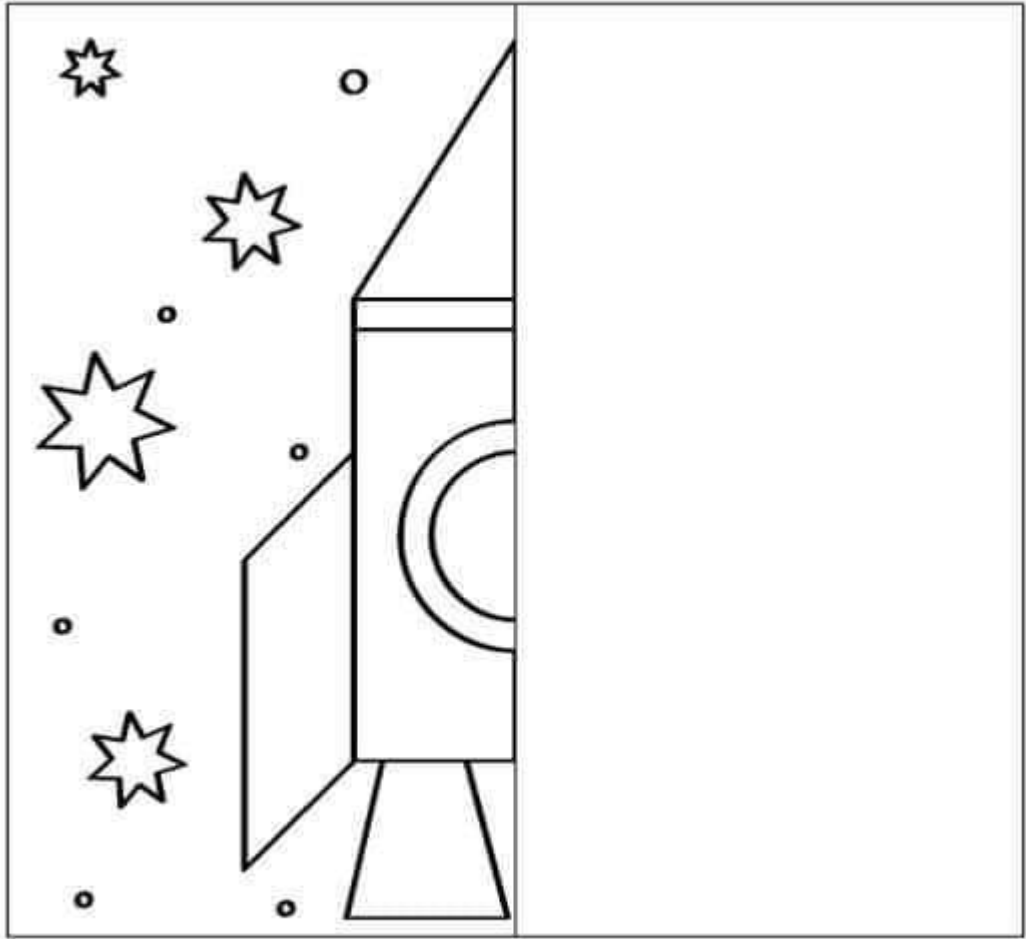

[www.detiseti.ru](http://www.detiseti.ru)

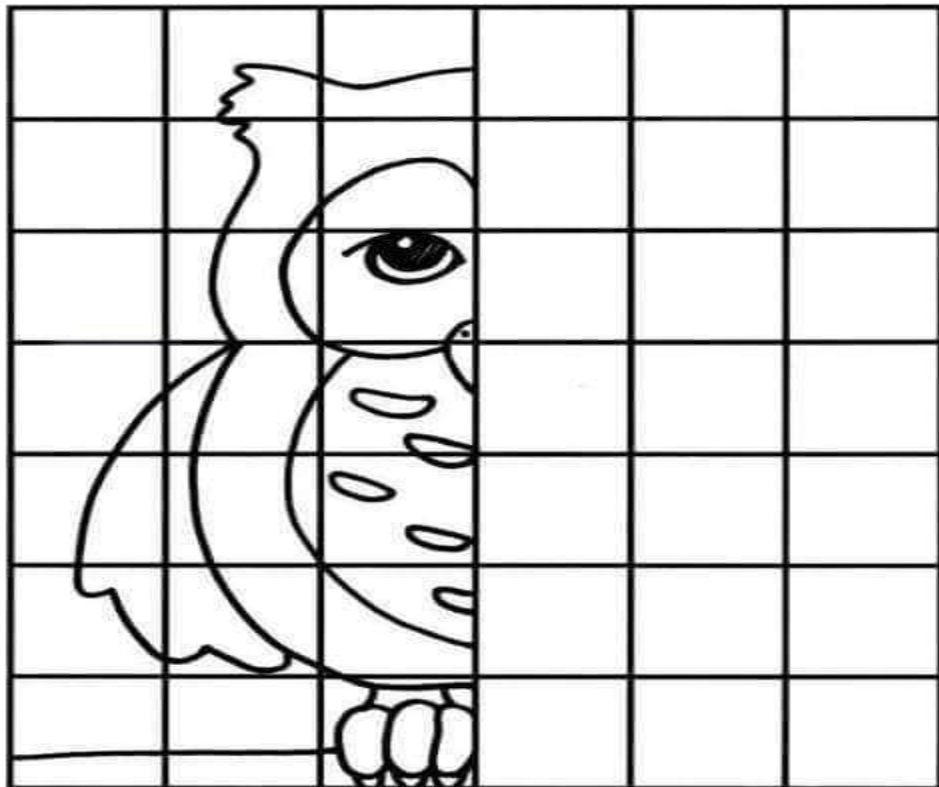

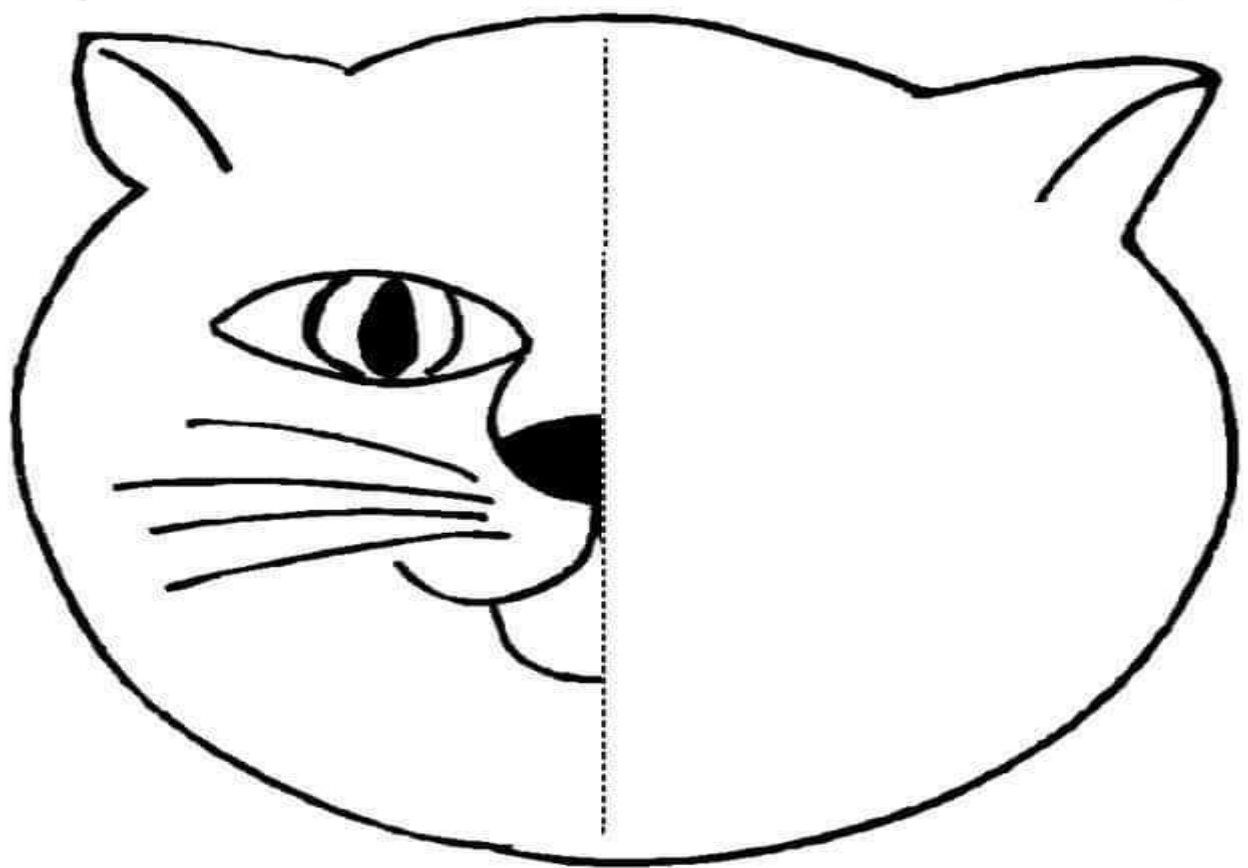
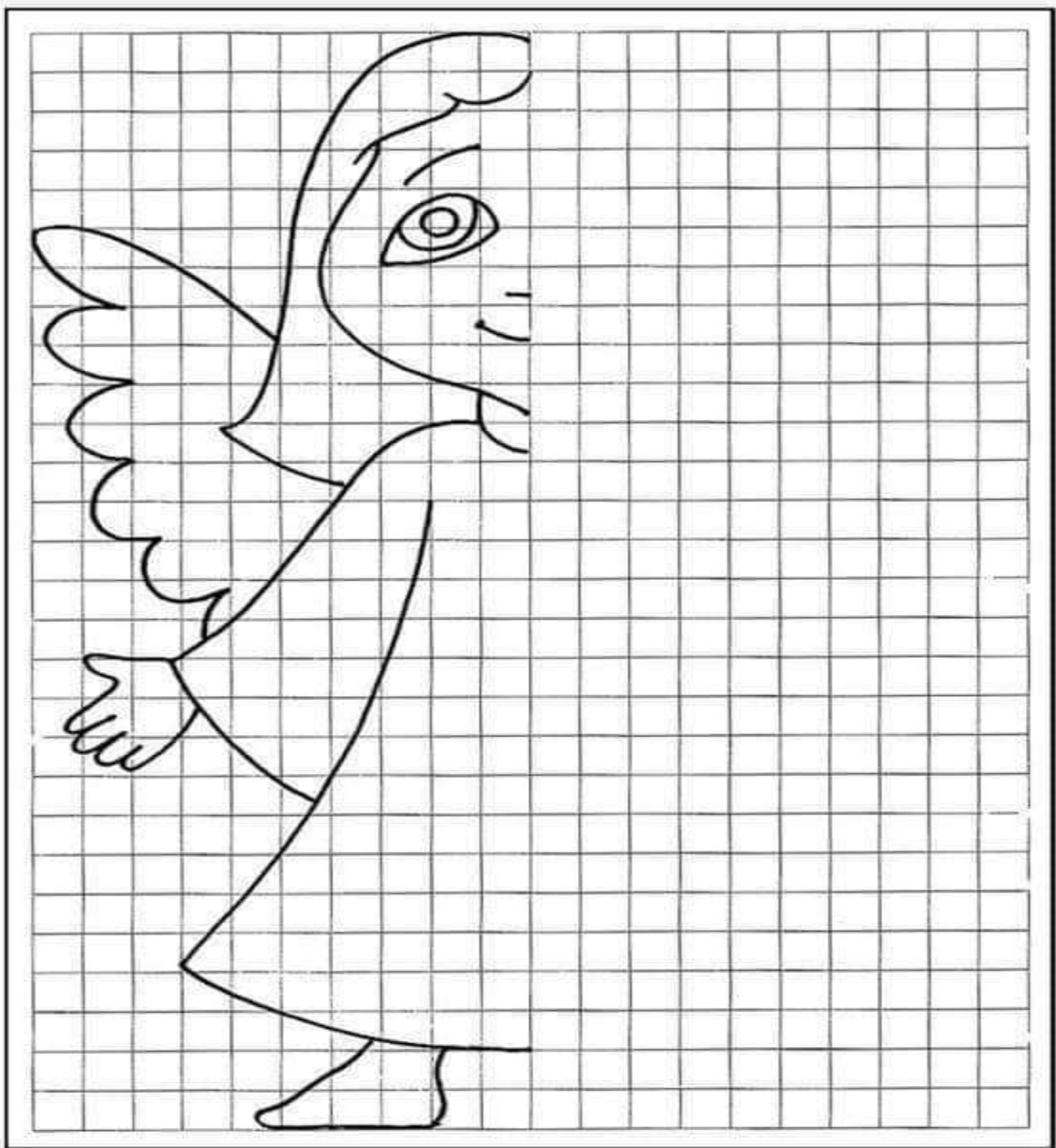

caminito caminito



caminito caminito

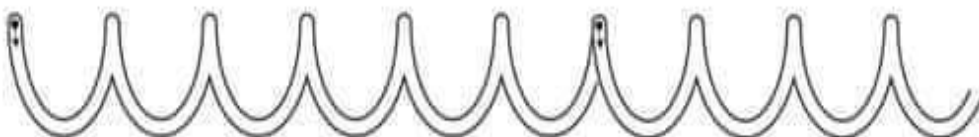
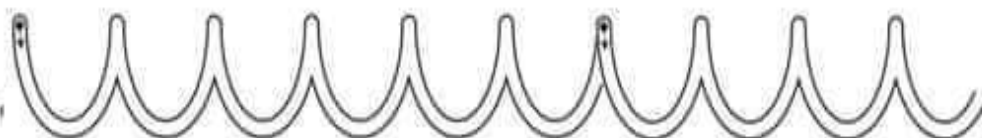
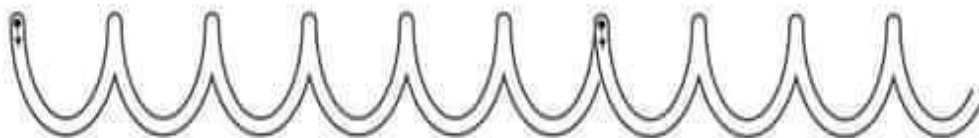
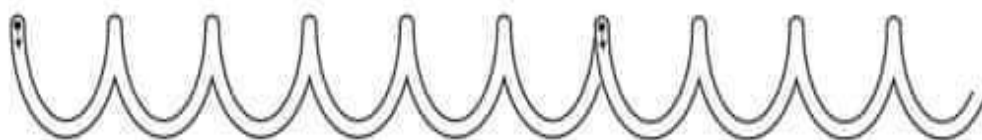

caminito caminito





caminito caminito

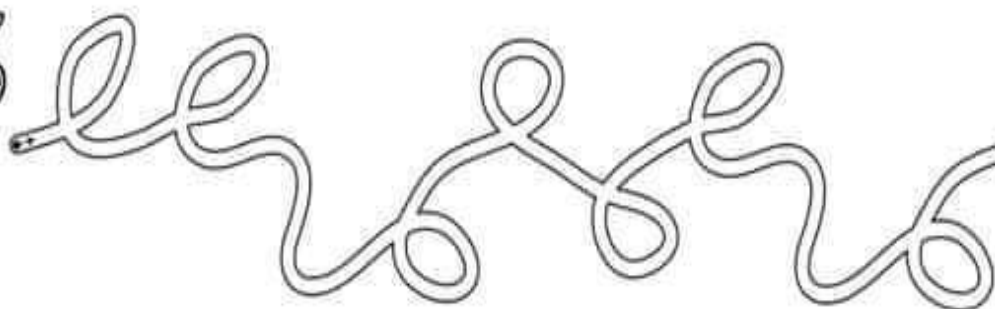
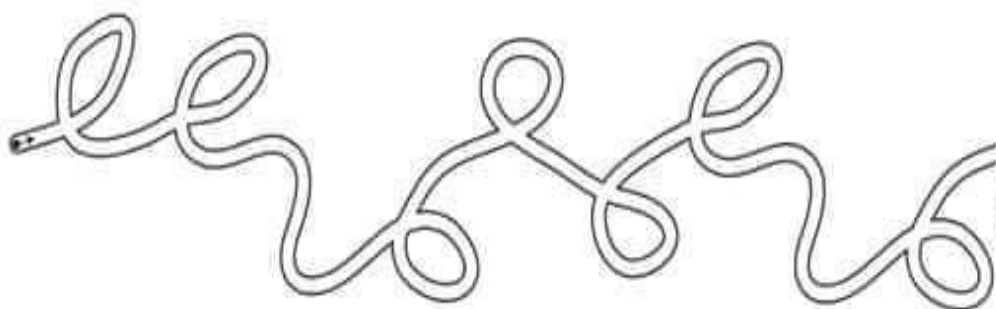
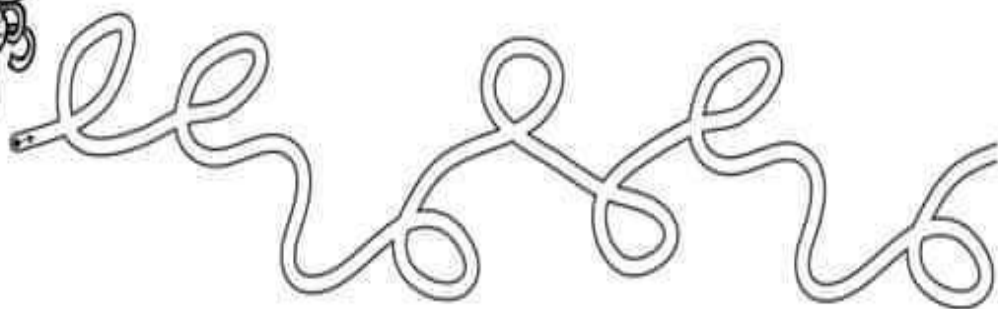

caminito caminito

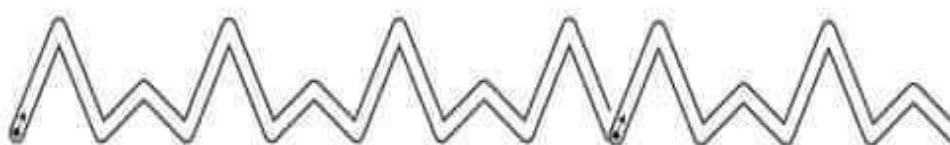

caminito caminito

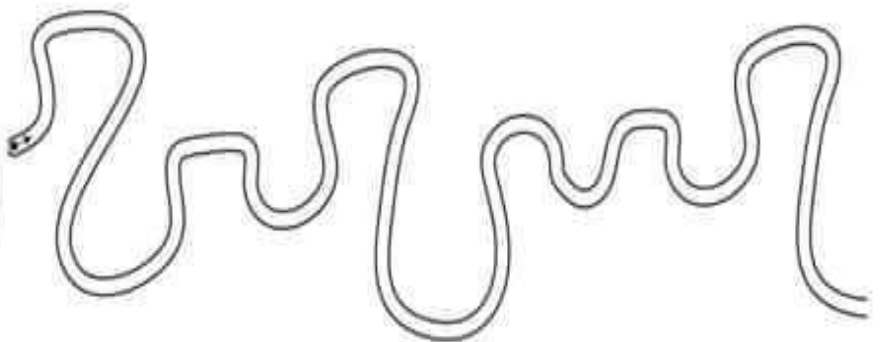
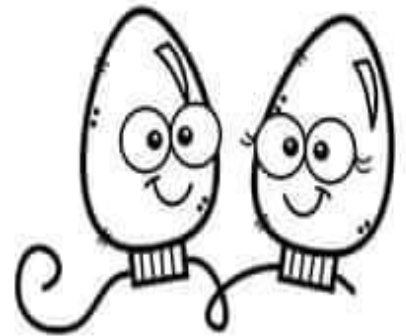
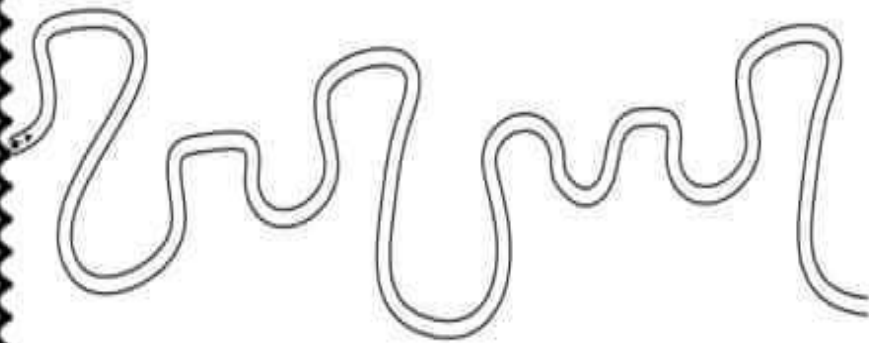
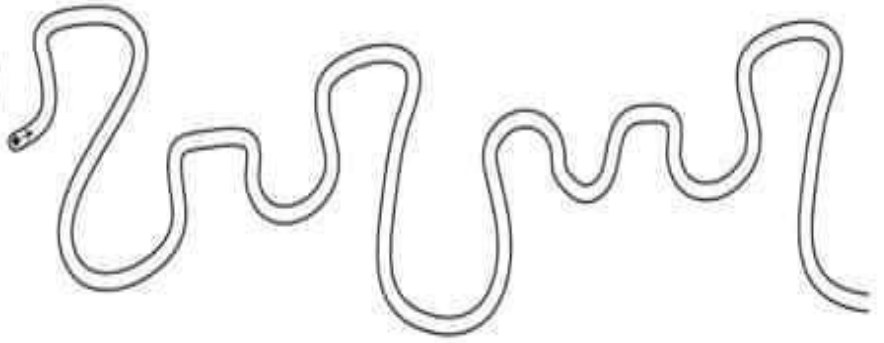
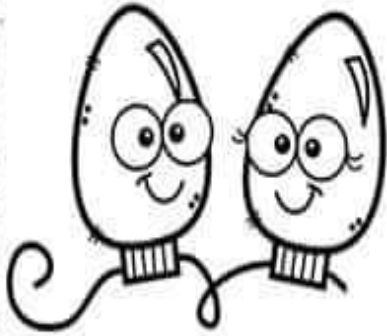

Help the Tractor Get to the Barn v.1

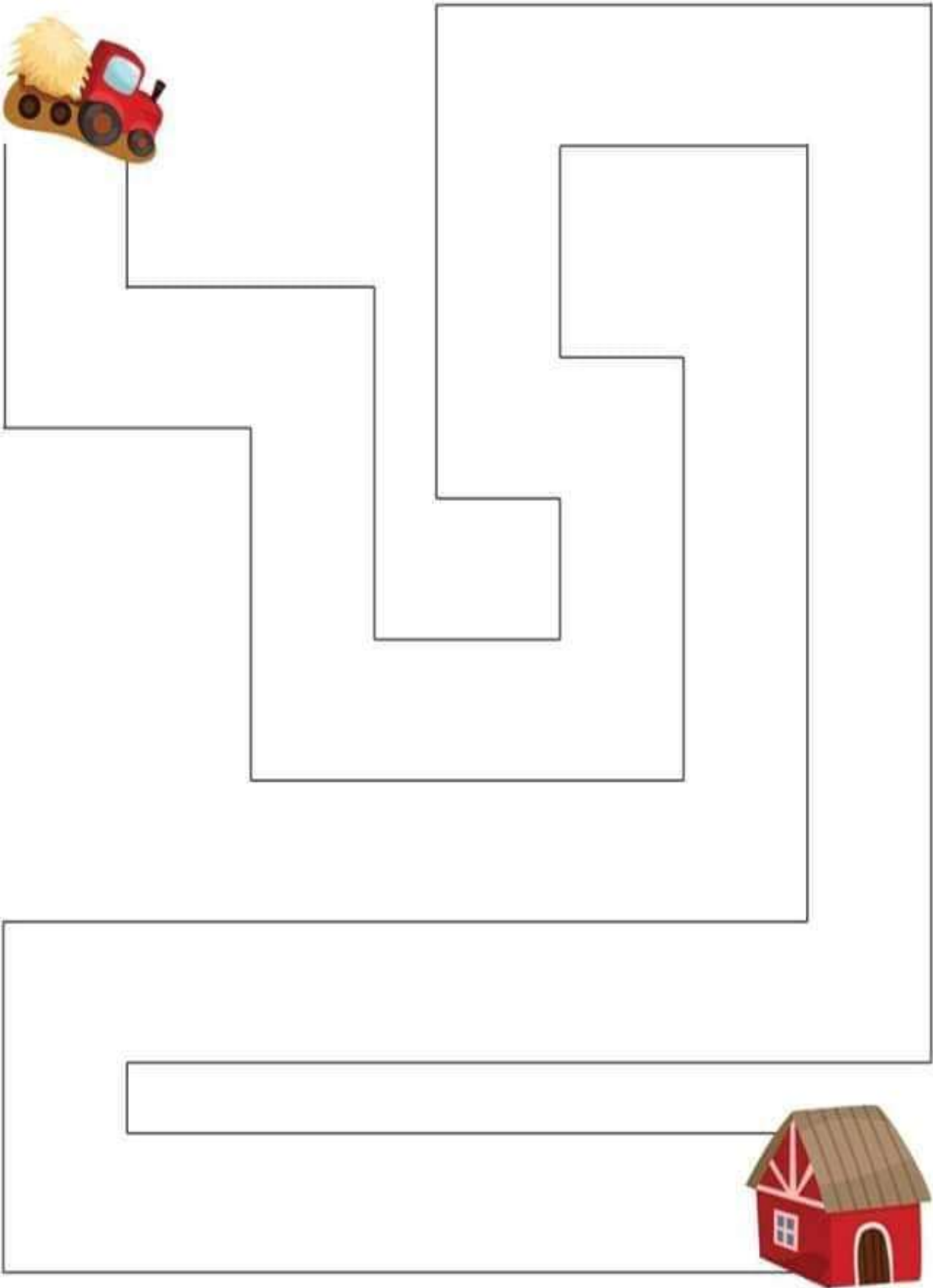

# Help the Tractor Get to the Barn v.3

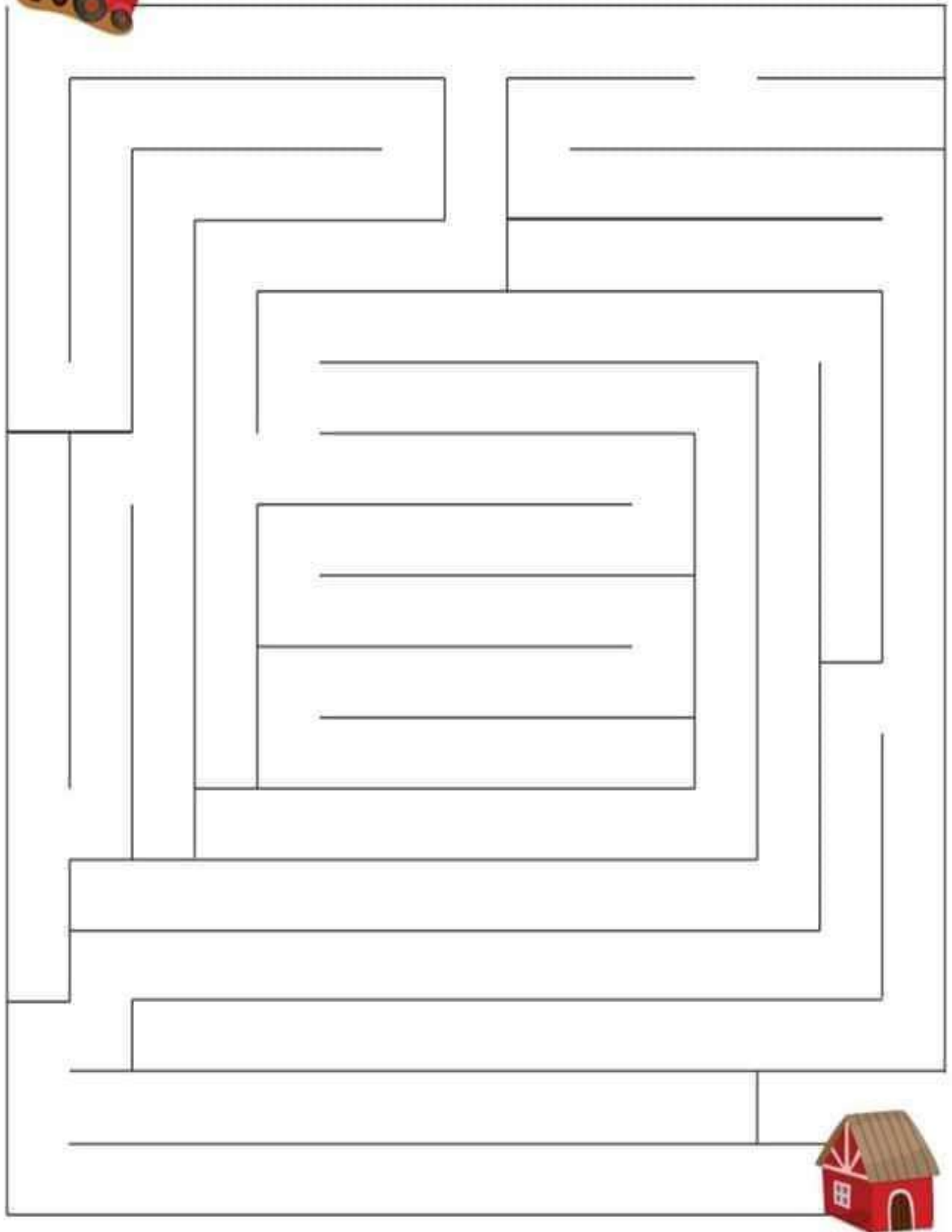



☆☆☆☆☆

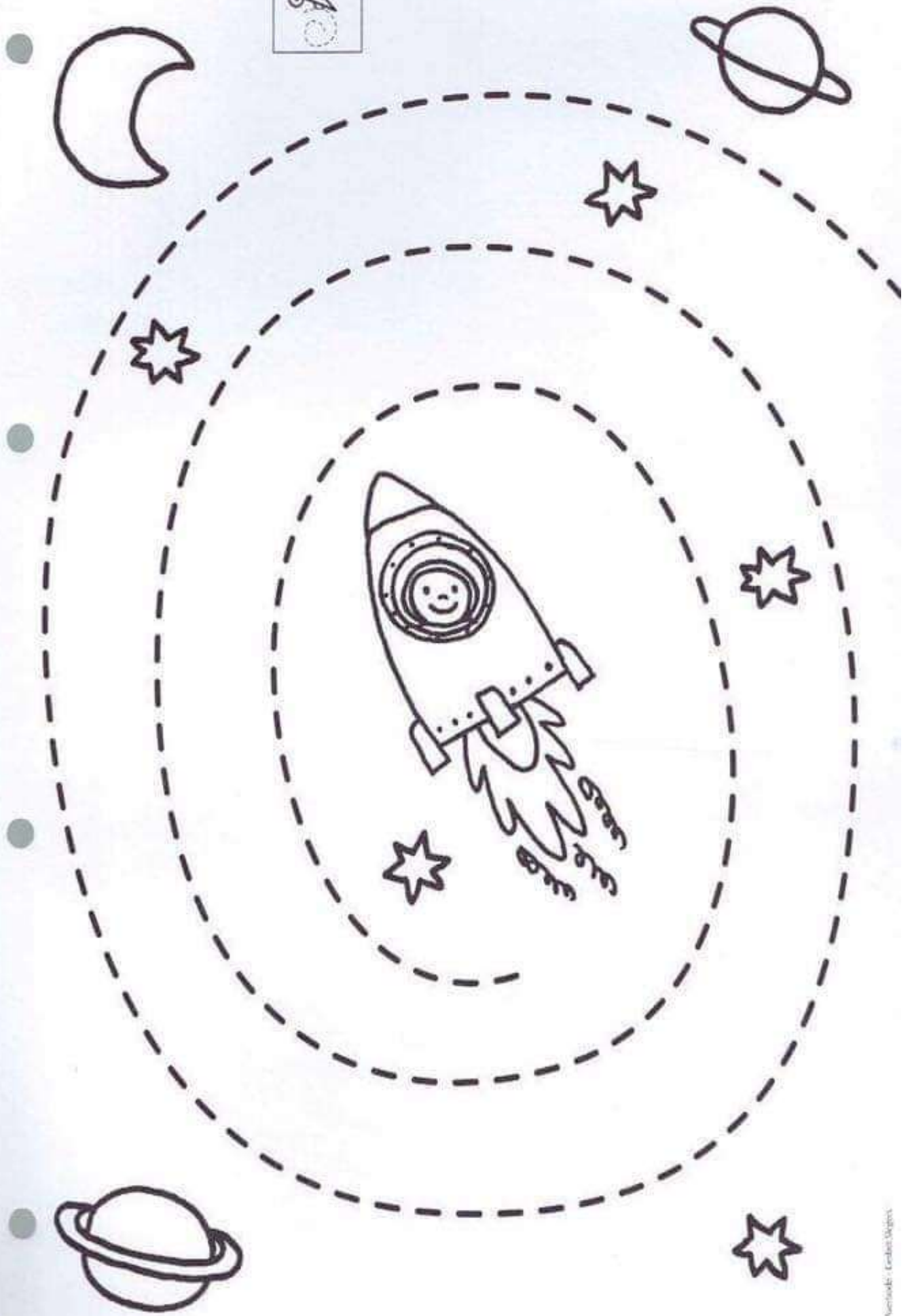

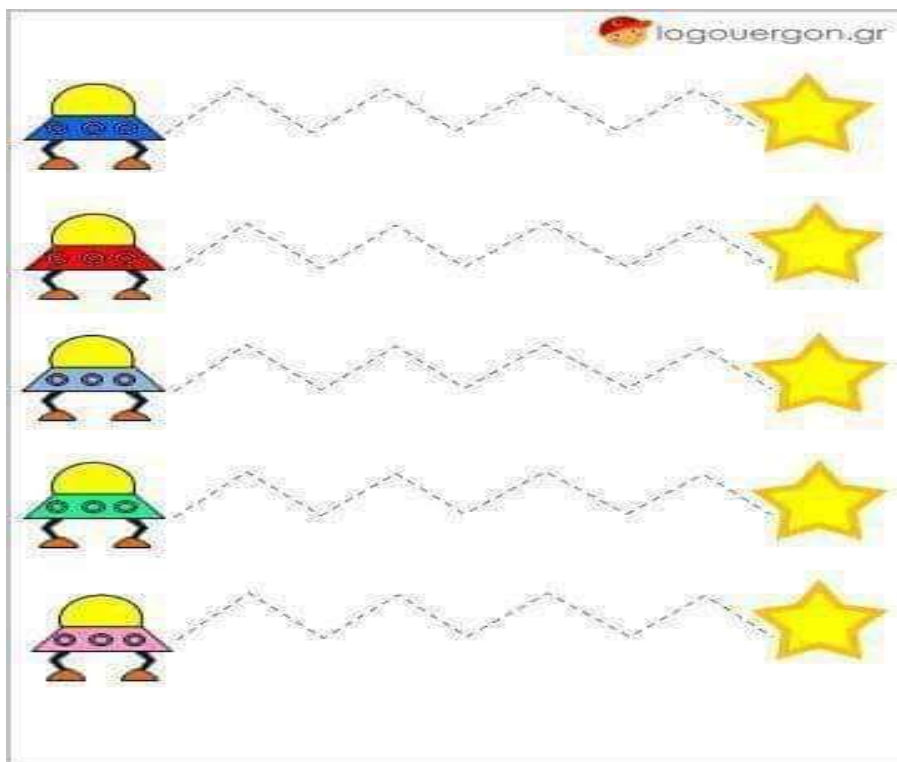
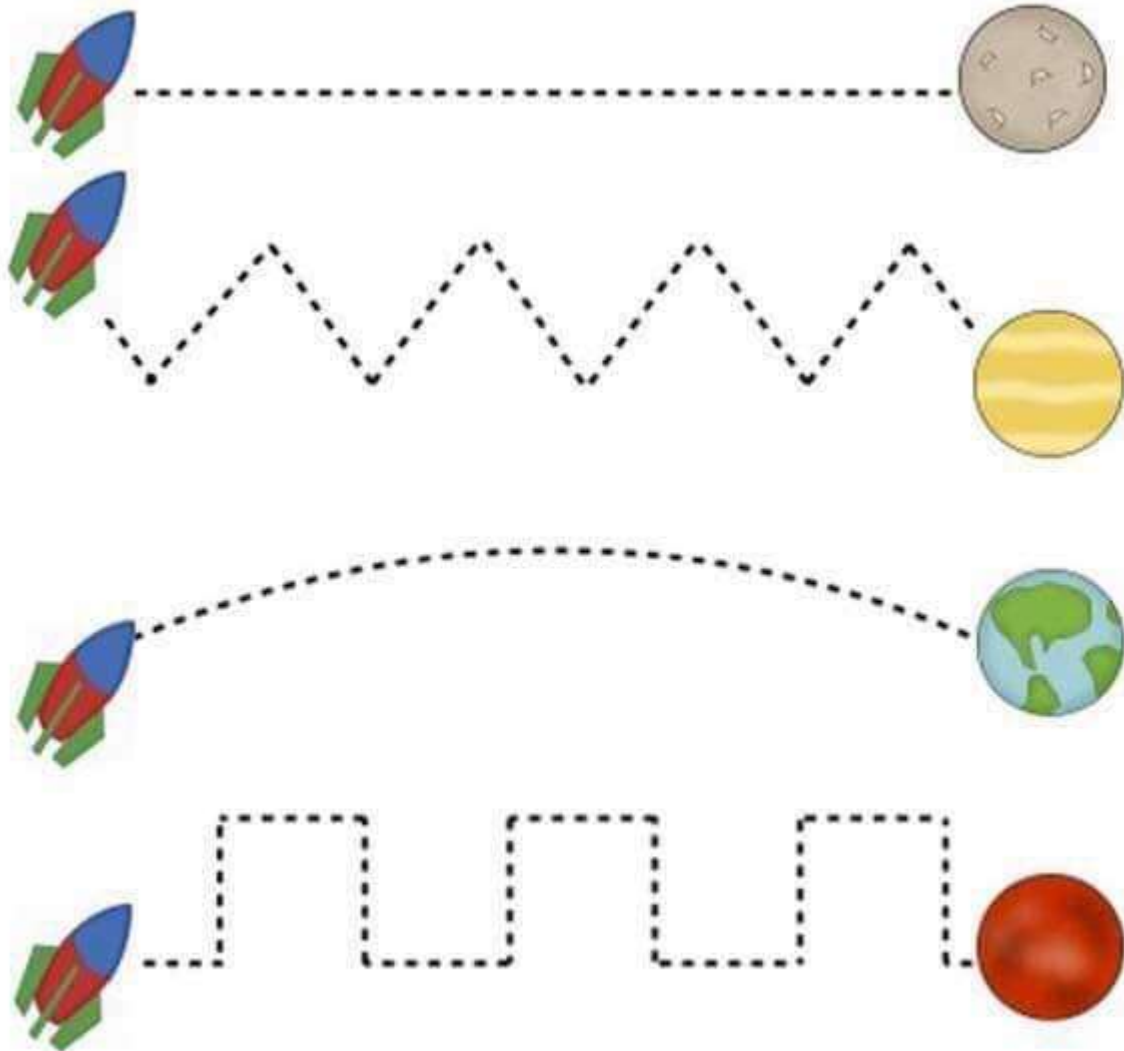

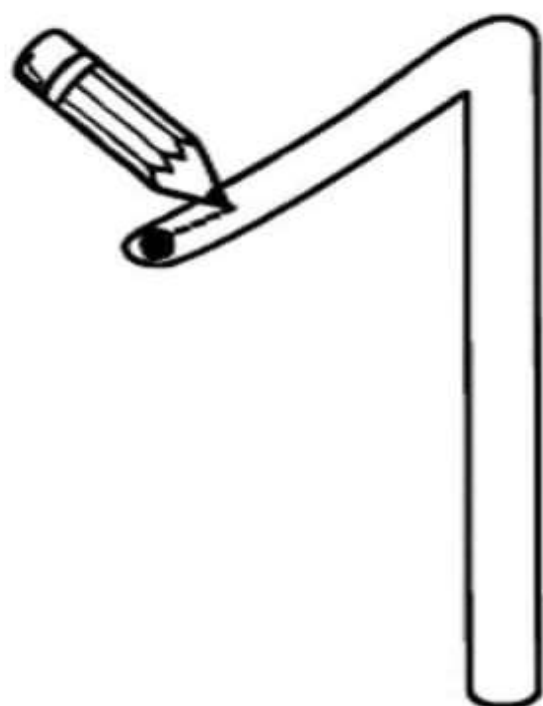
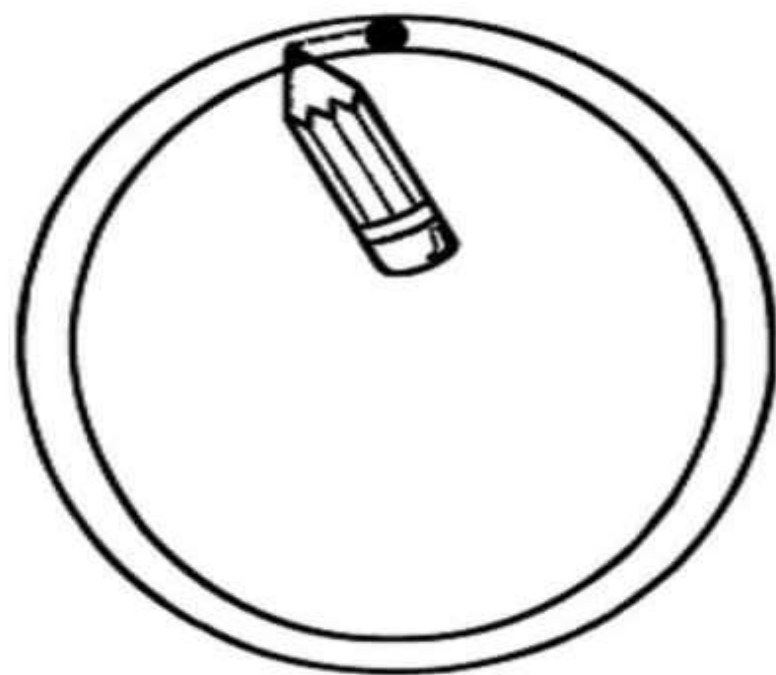



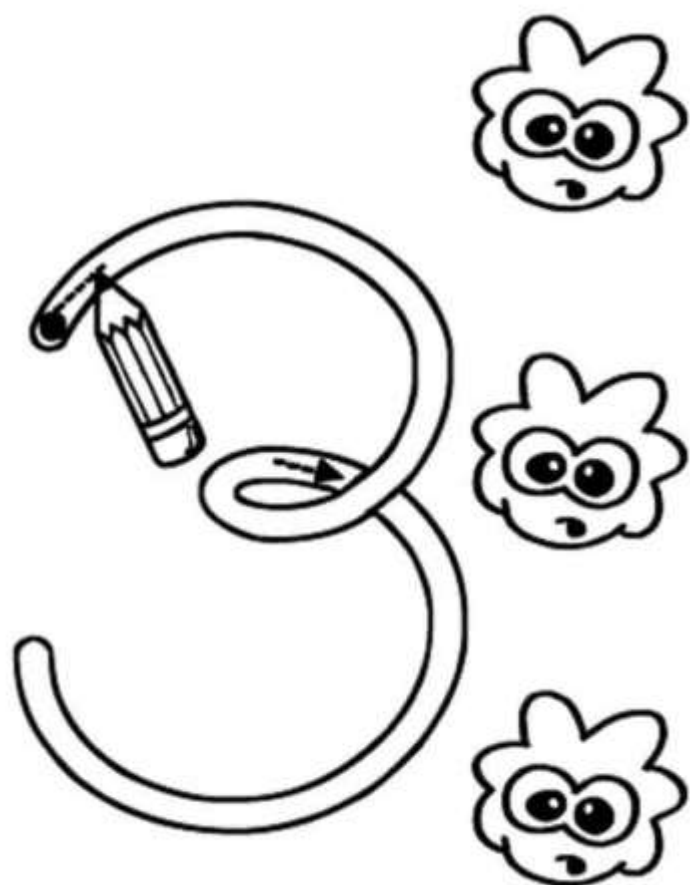
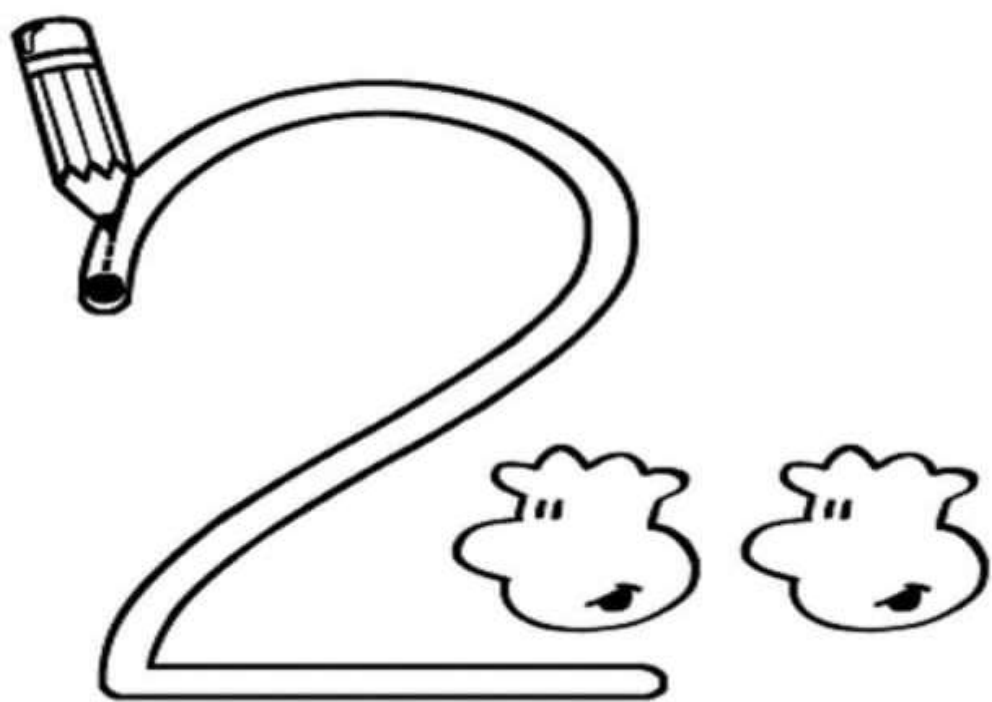

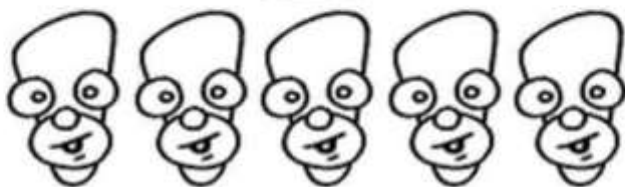
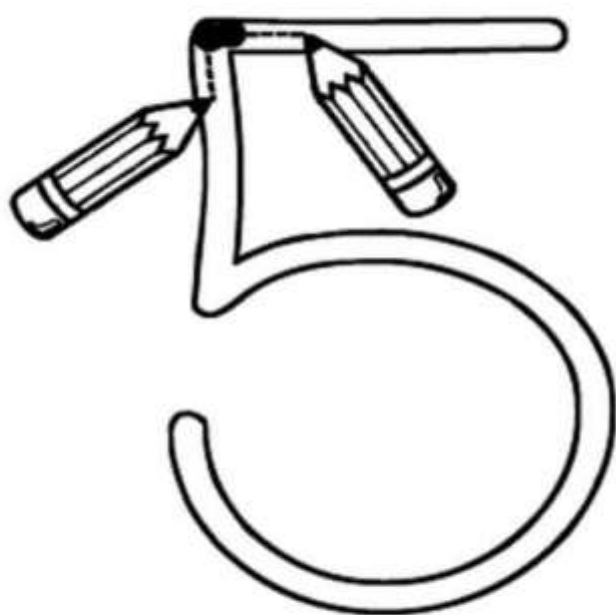
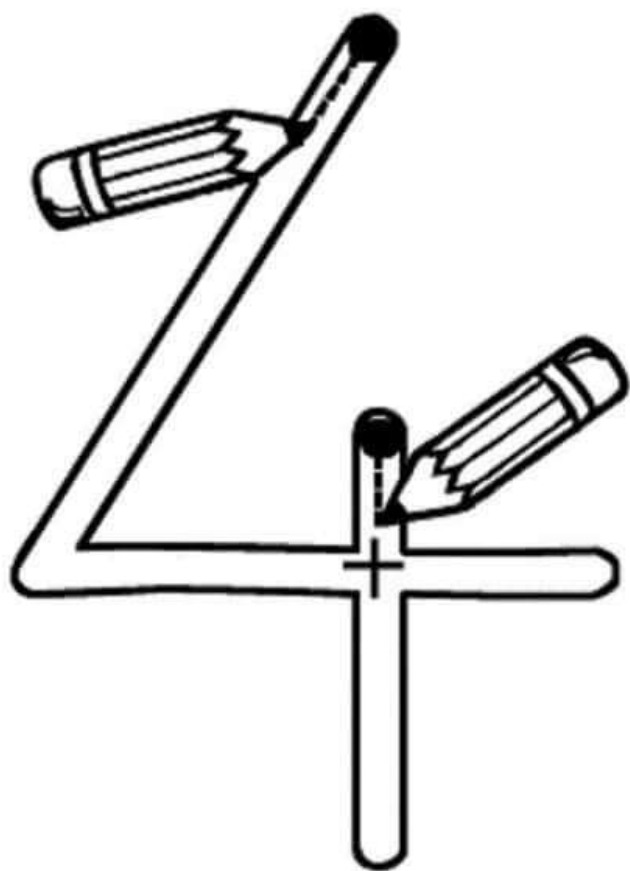

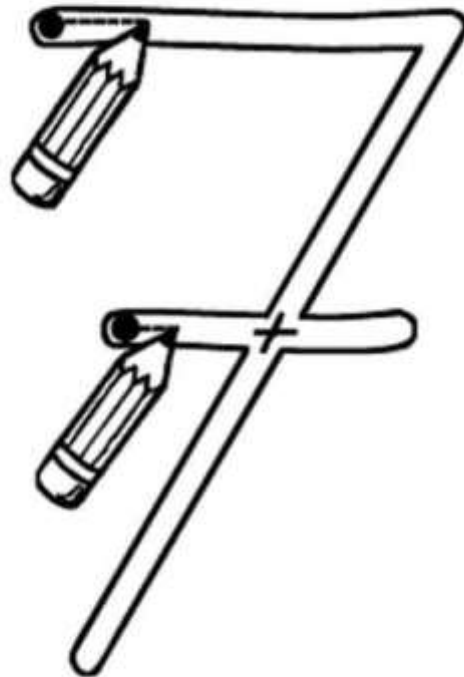
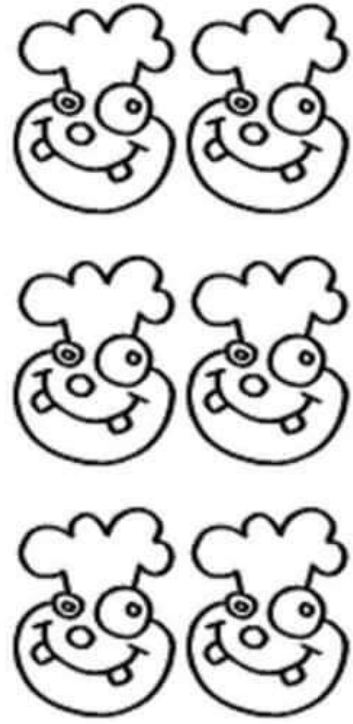

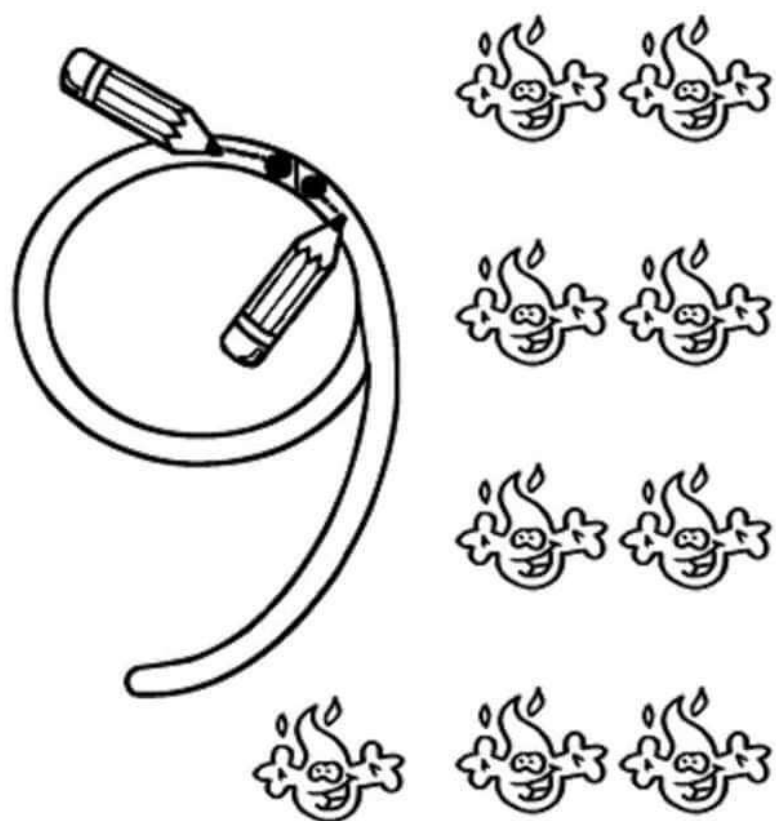
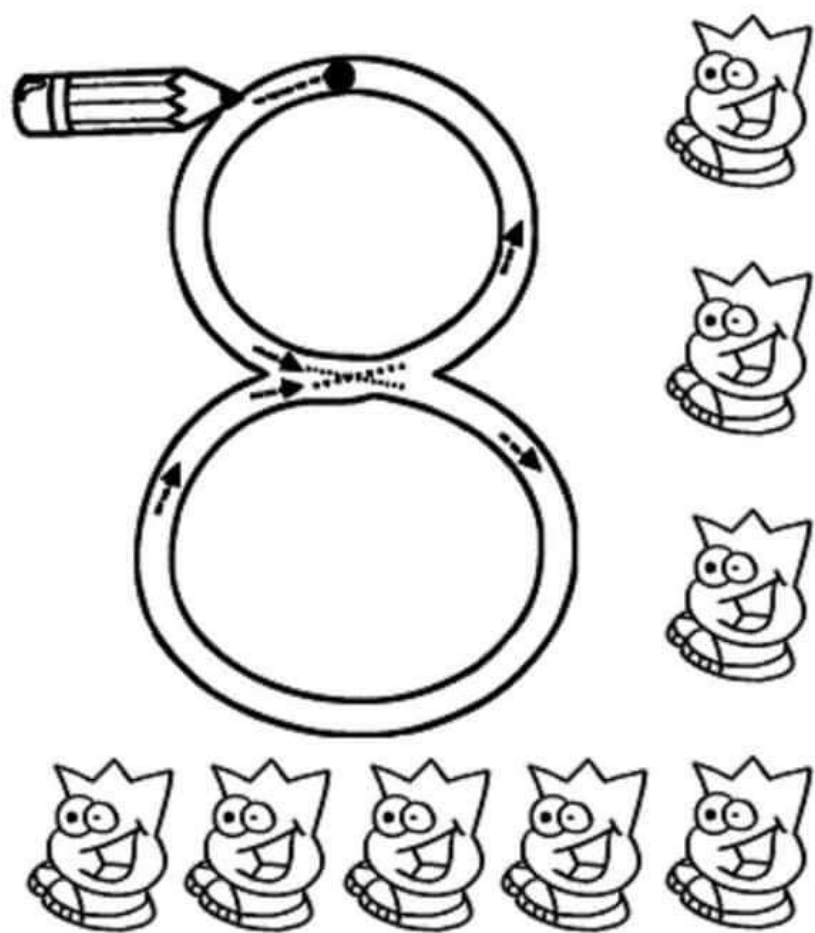

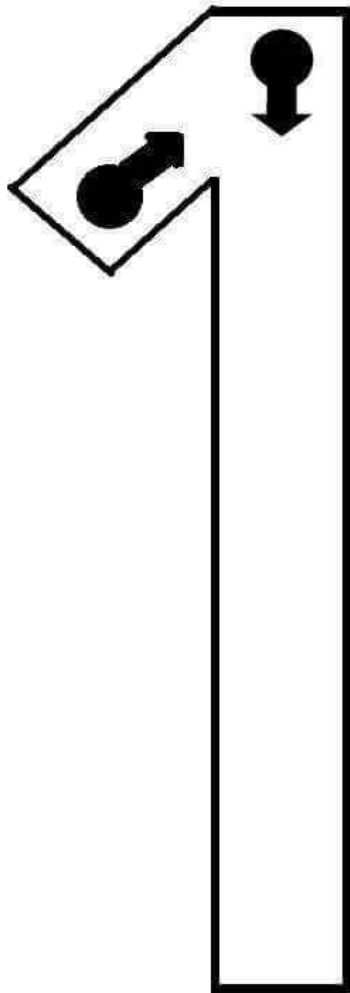
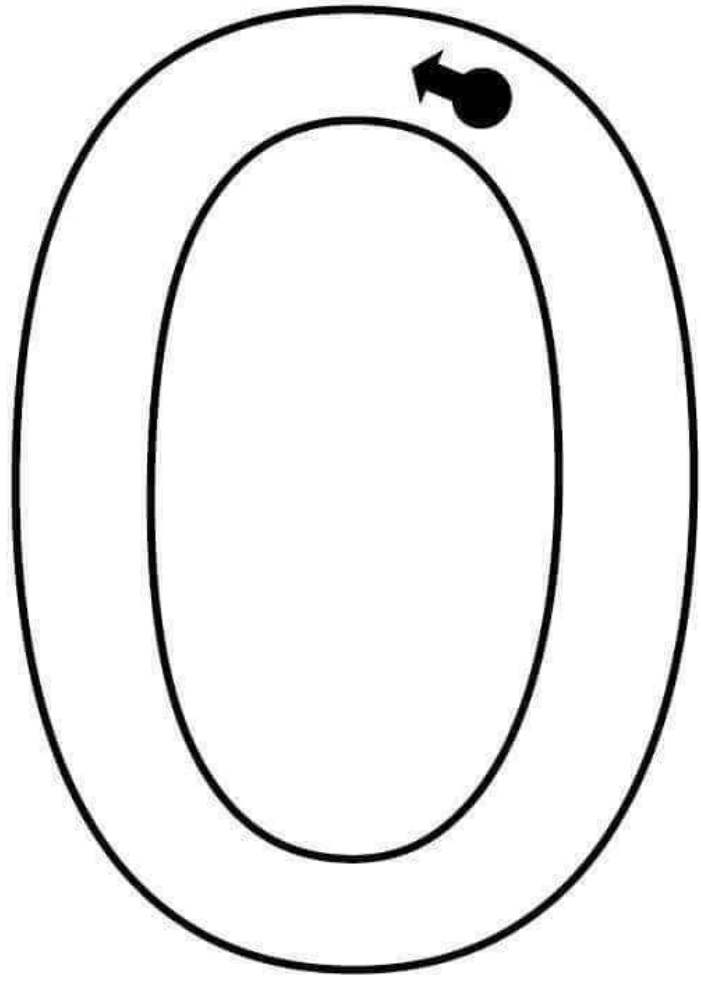

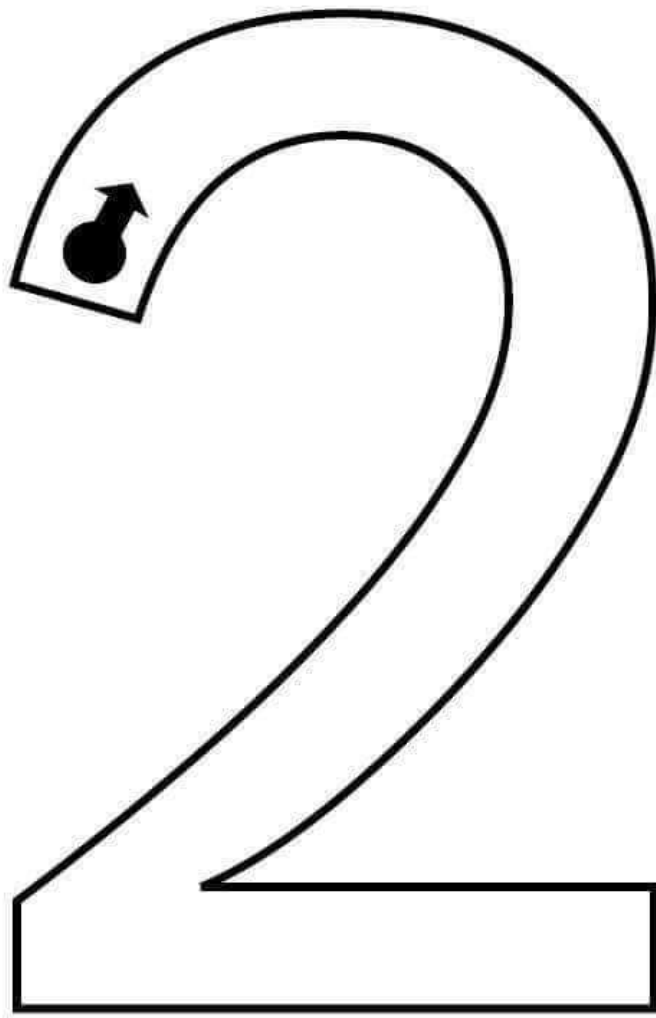

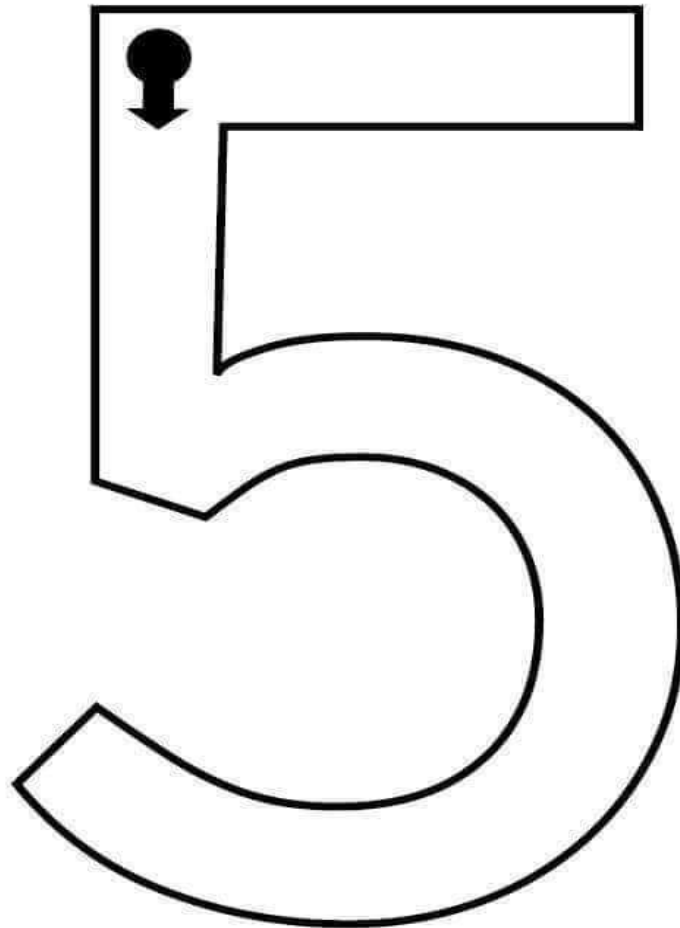
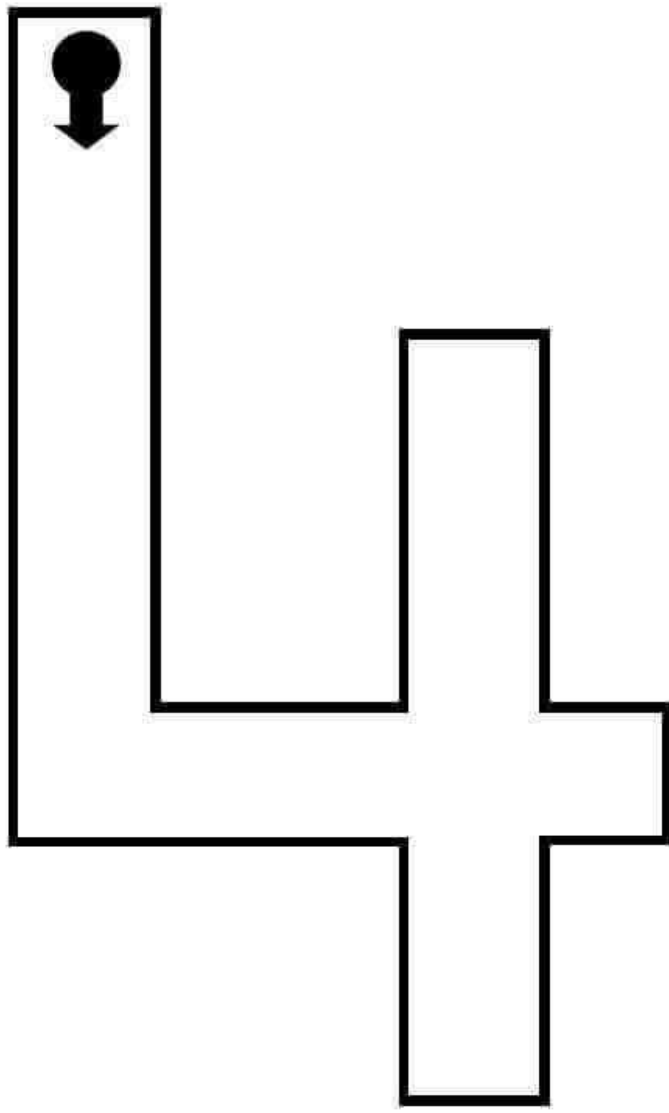

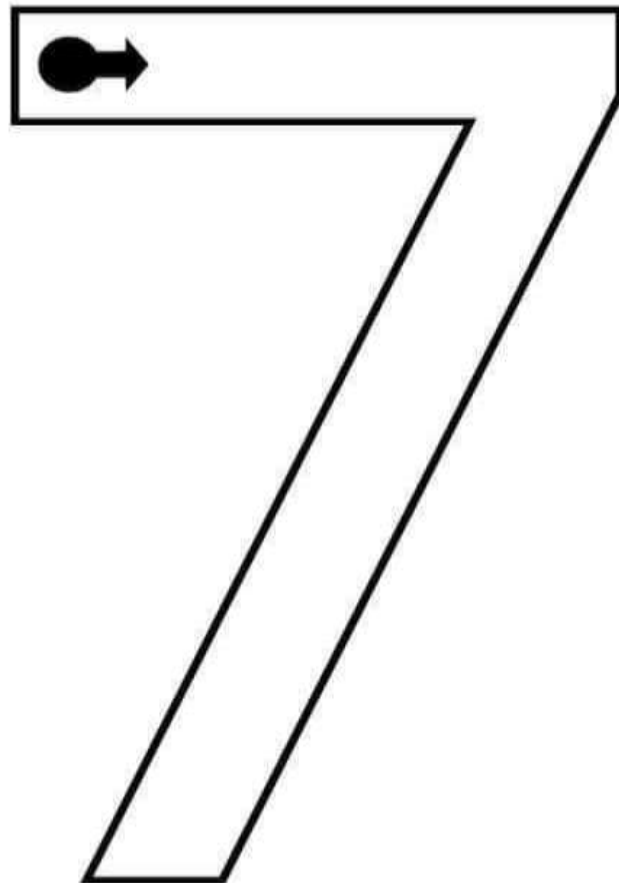
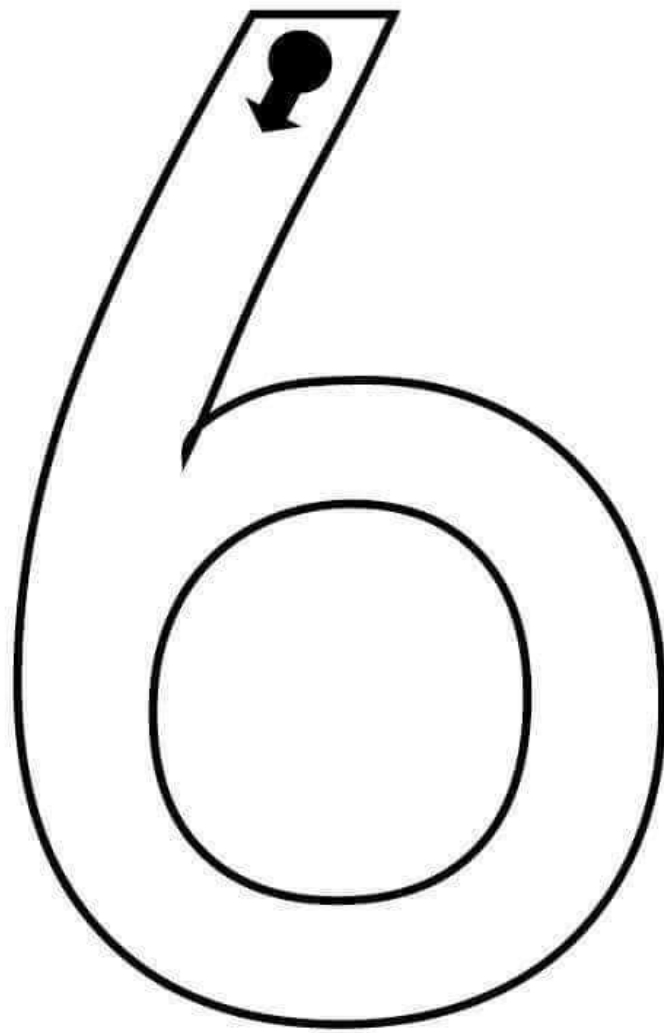



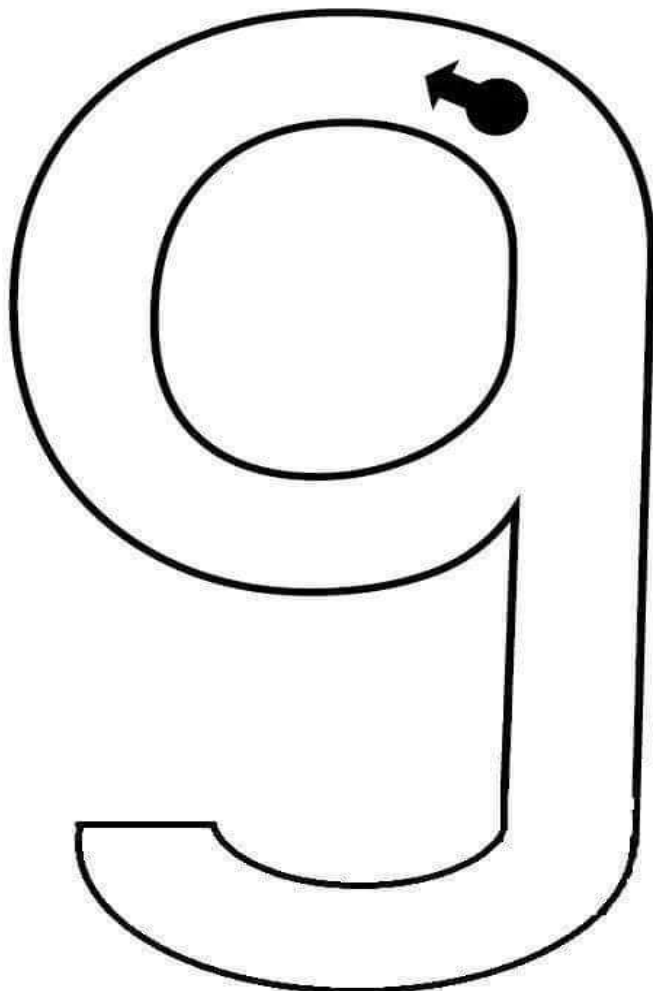
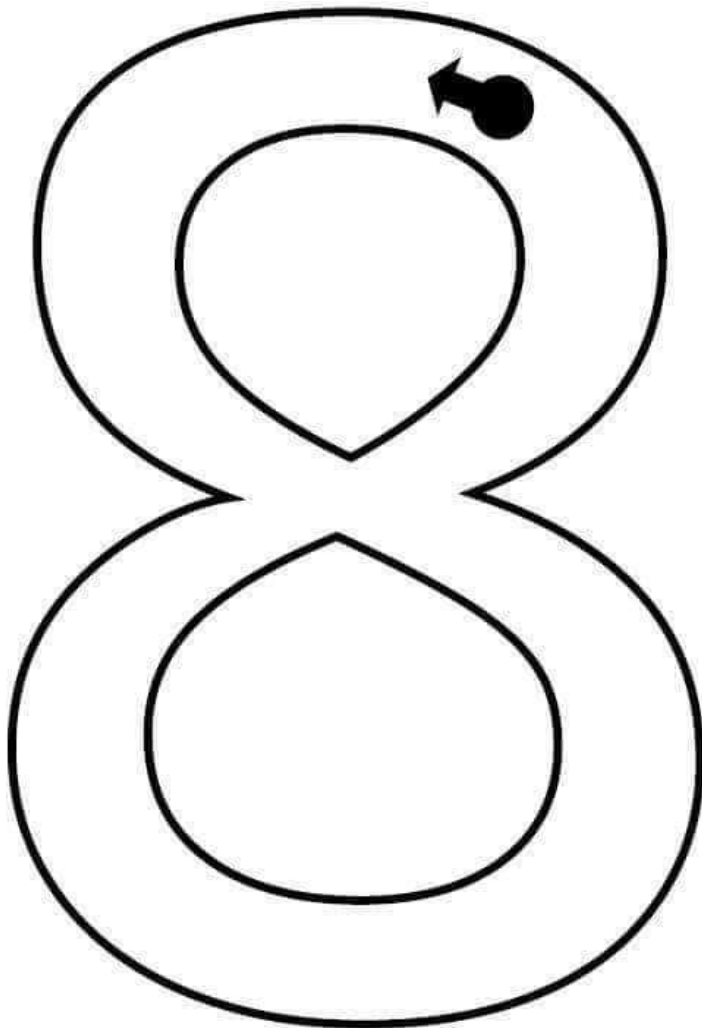

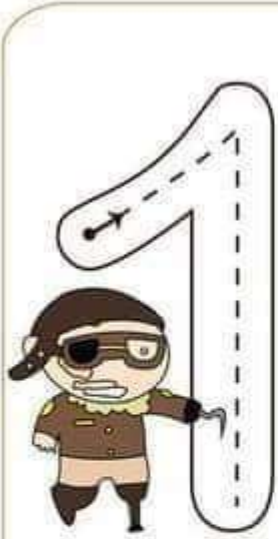

A large dashed number 1 is shown on the left, with a small pilot character standing next to it. The pilot is wearing a brown uniform and goggles. The number 1 has a dashed line and an arrow indicating the starting point and direction of the stroke.

1 1 1 1 1 1

1 1 1 1 1 1

1 1 1 1 1 1 1 1

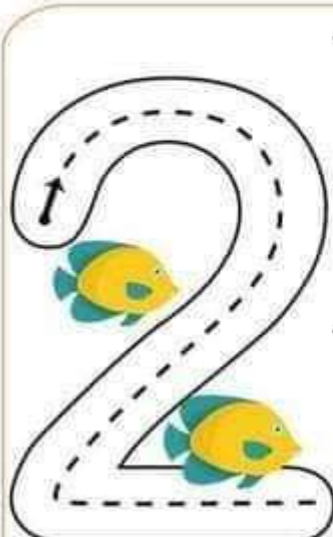

A large dashed number 2 is shown on the left, with two small yellow and blue fish swimming around it. The number 2 has dashed lines and arrows indicating the starting point and direction of the two strokes.

2 2 2 2 2 2

2 2 2 2 2 2

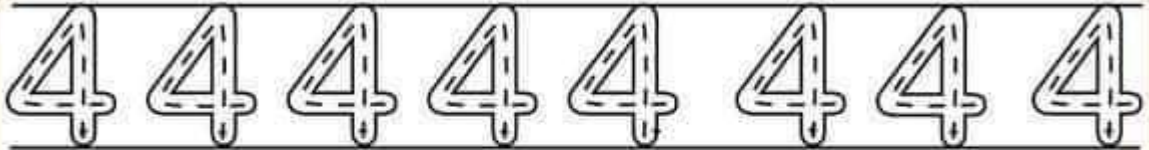
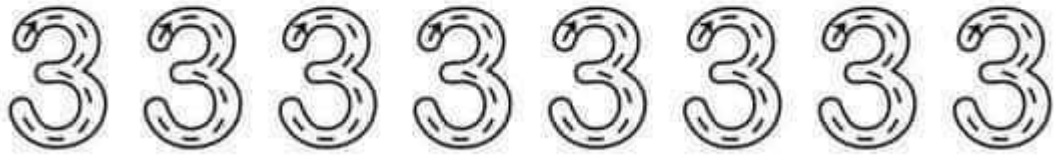
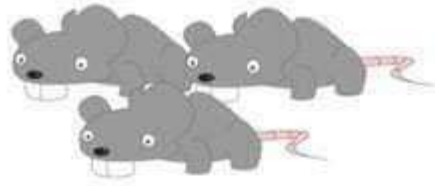

2 2 2 2 2 2 2 2



5 5 5 5 5 5 5 5

5 5 5 5 5 5 5 5

5 5 5 5 5 5 5 5



edufarmaceutica Editorial



© Grupo GEFARMEIA www.gefarmeia.com

educapocques

6 6 6 6 6 6 6 6

6 6 6 6 6 6 6 6

6 6 6 6 6 6 6 6



edufarmaceutica Editorial

© Grupo GEFARMEIA www.gefarmeia.com

educapocques

7 7 7 7 7 7 7 7

7

7 7 7 7 7 7

7 7 7 7 7 7 7 7

8 8 8 8 8 8 8 8

8

8 8 8 8 8 8 8

8 8 8 8 8 8 8 8

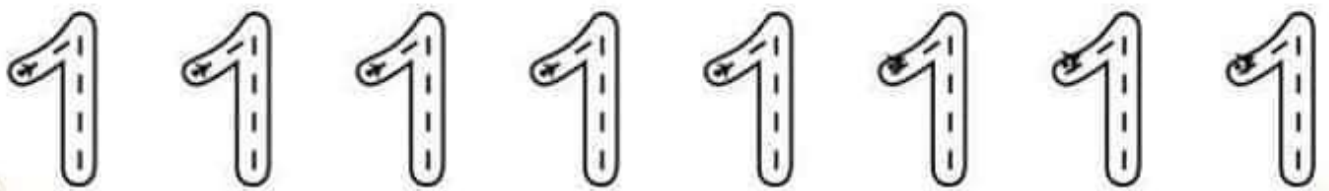
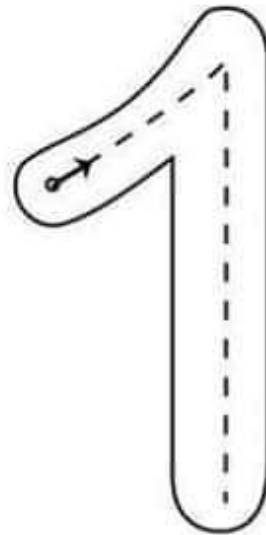
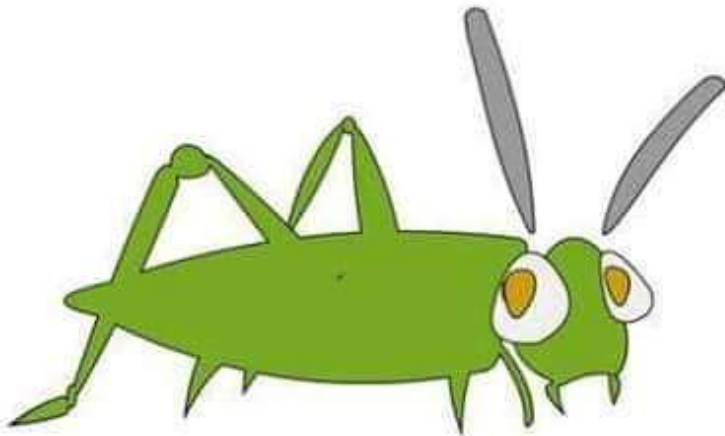
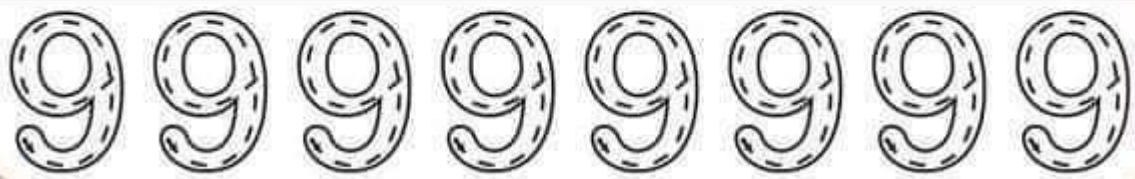
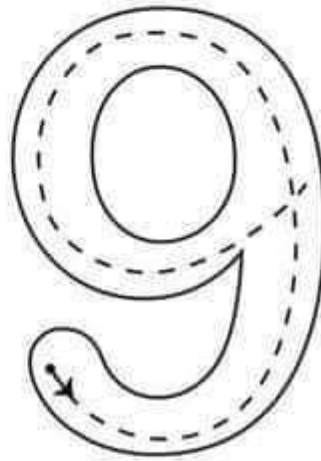
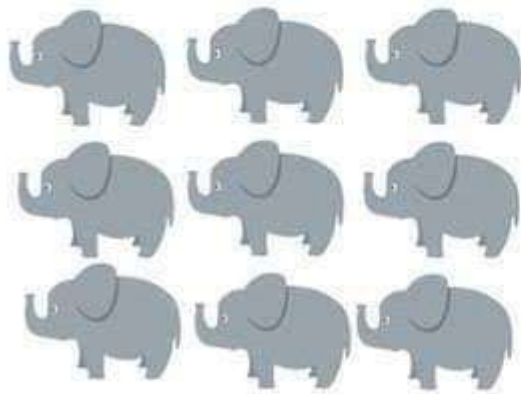

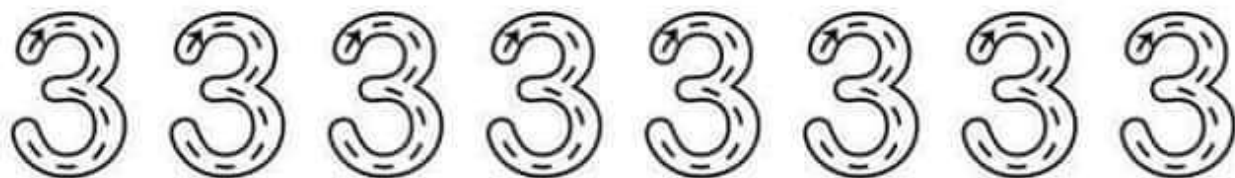
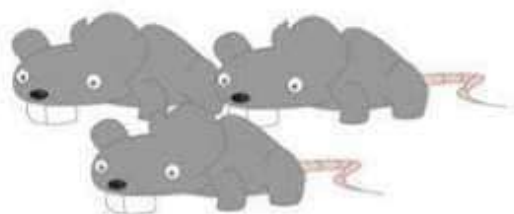

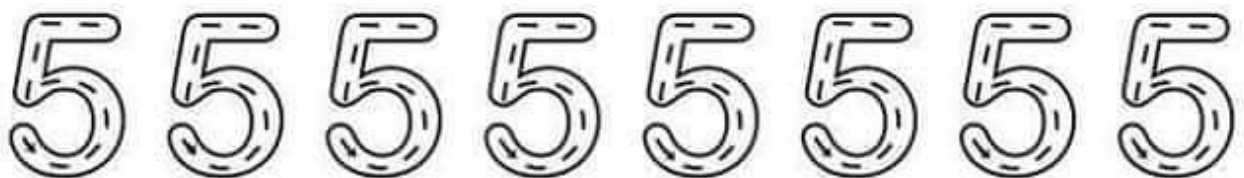
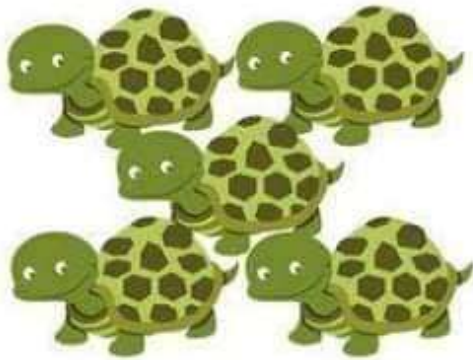
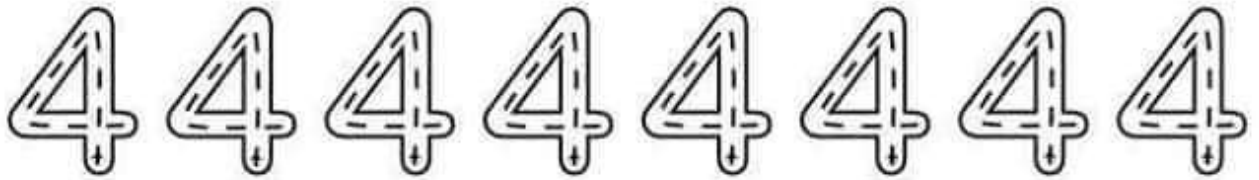
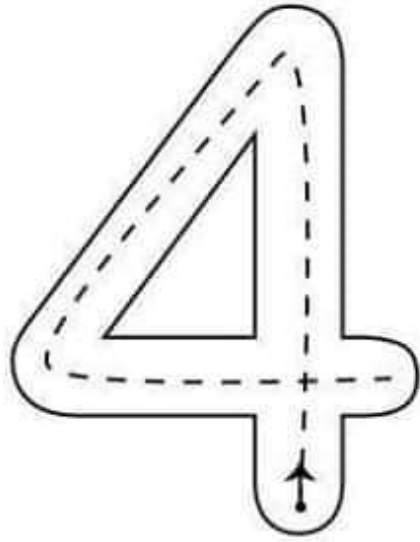
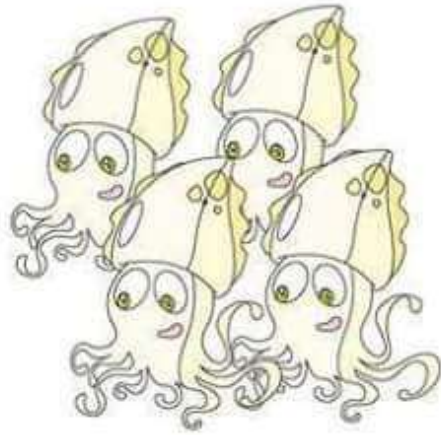



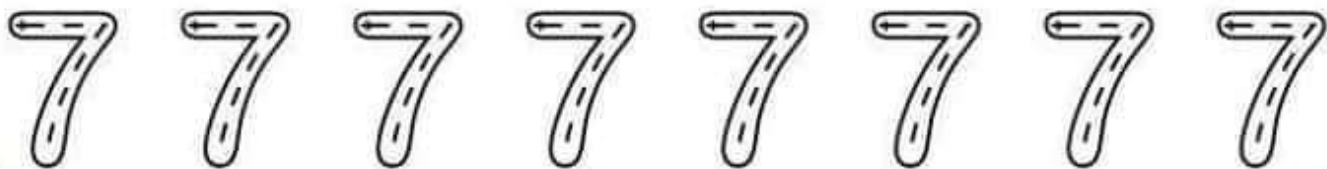
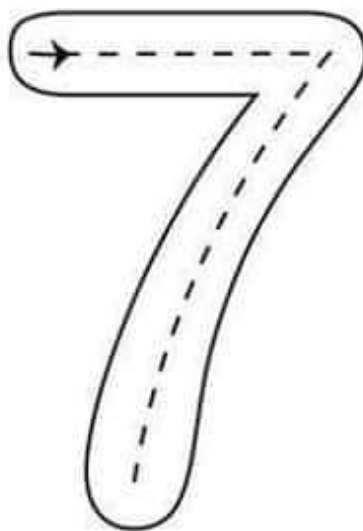
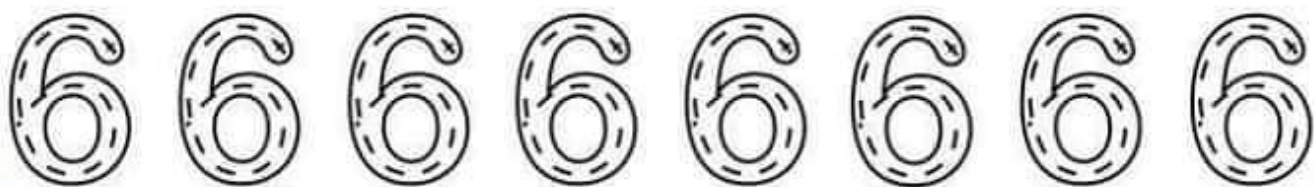
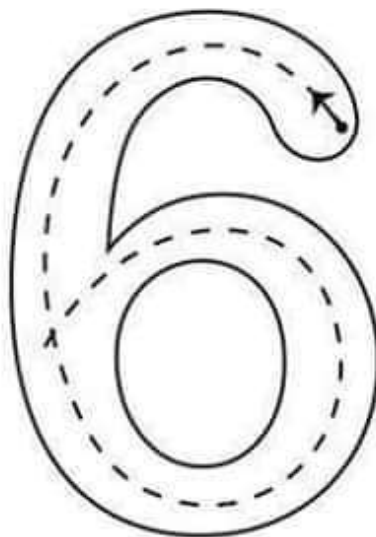

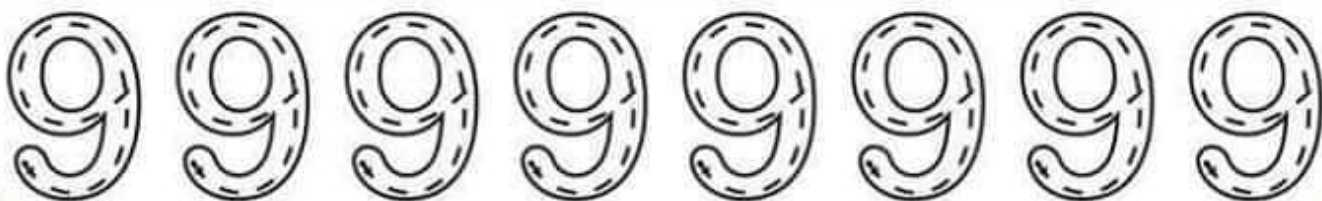
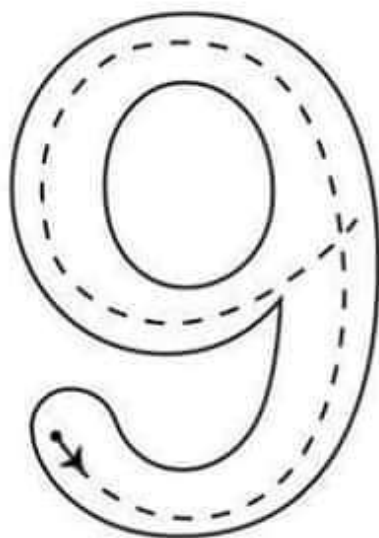
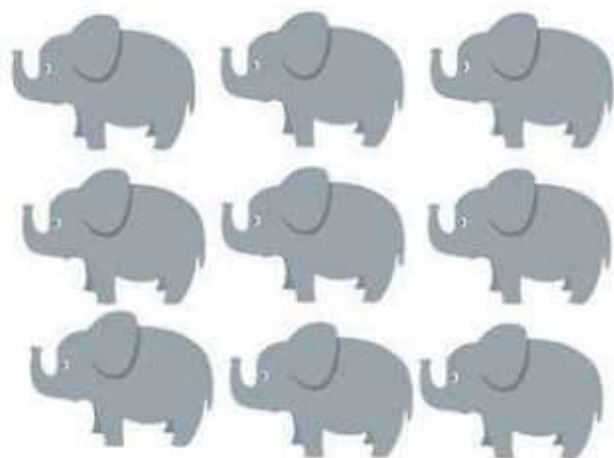
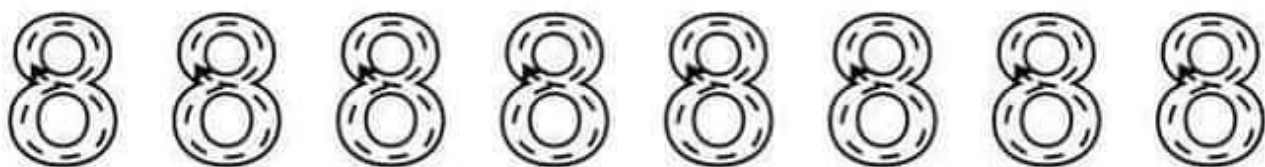
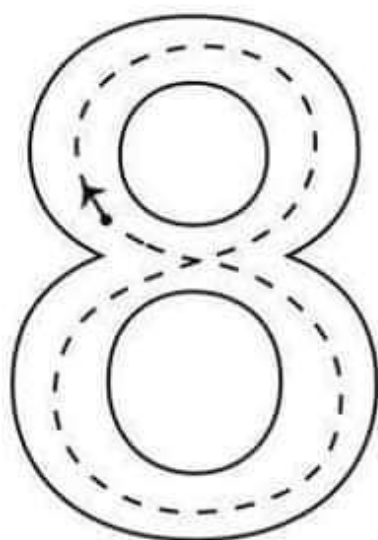
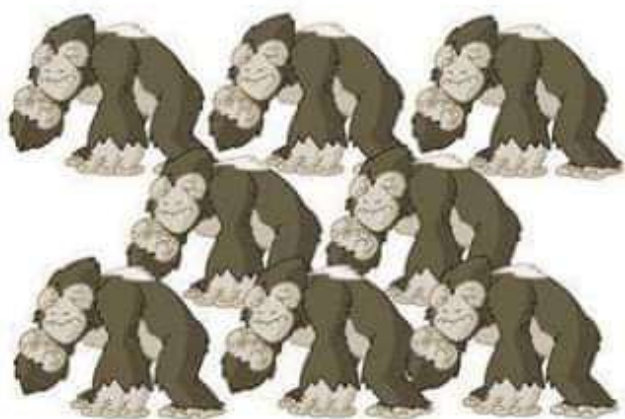

Проведи лінії сверху вниз по середине дорожек.

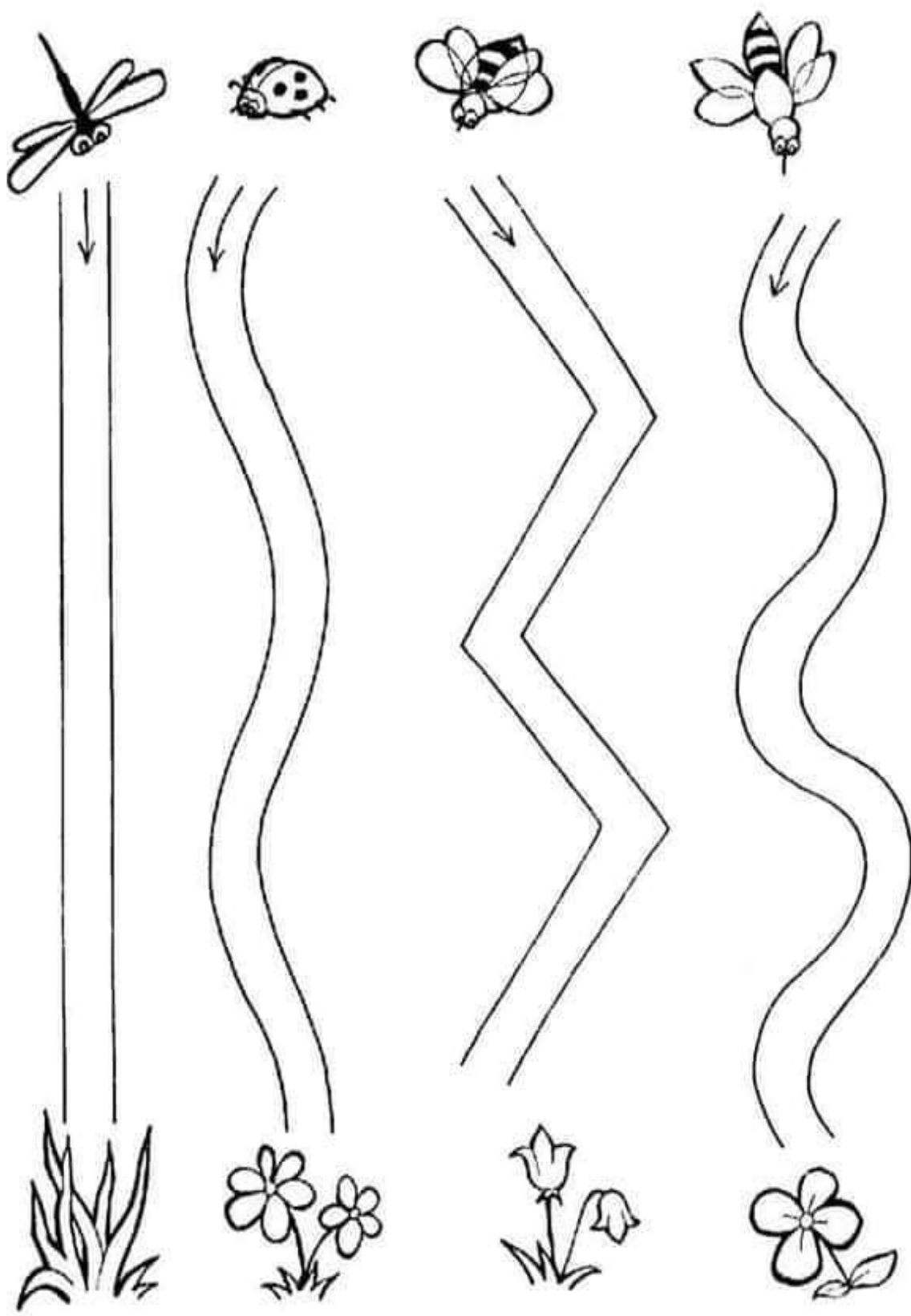

Помоги зверятам получить свой обед.

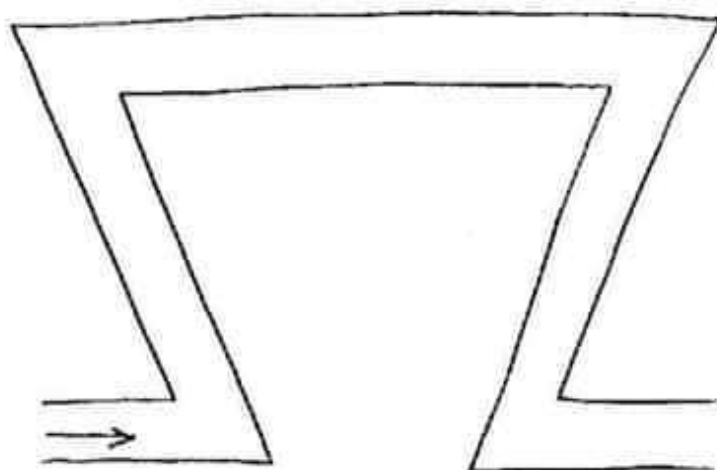
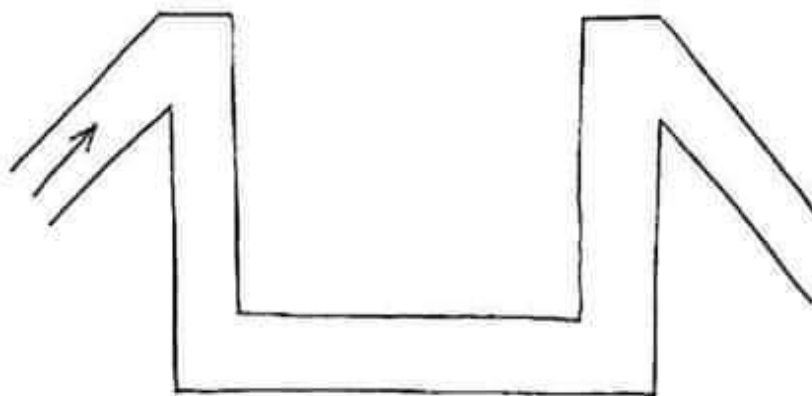
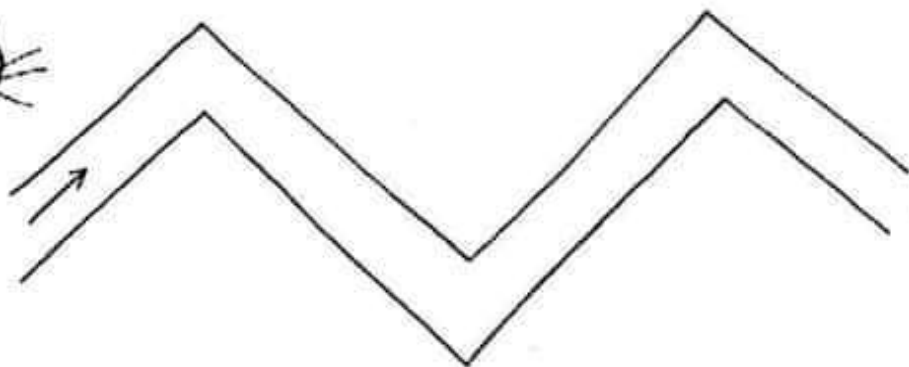

Проведи кораблики к островам.

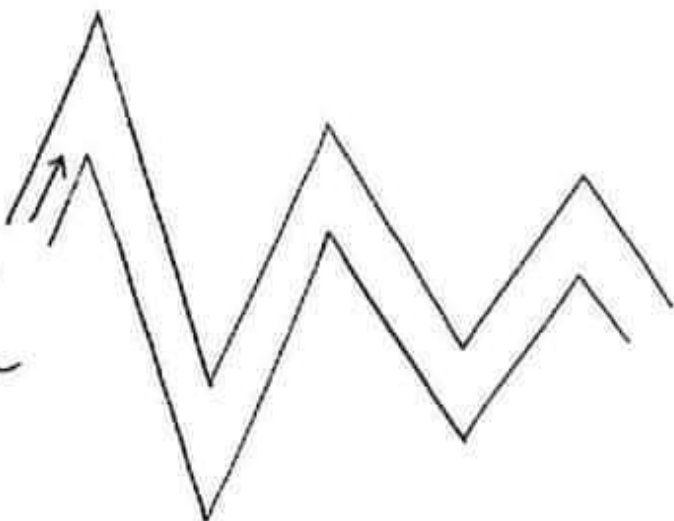
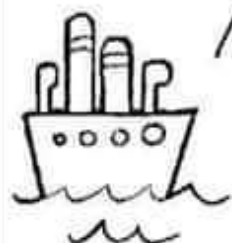
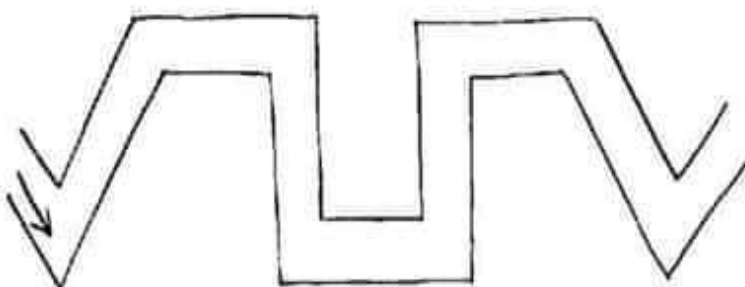
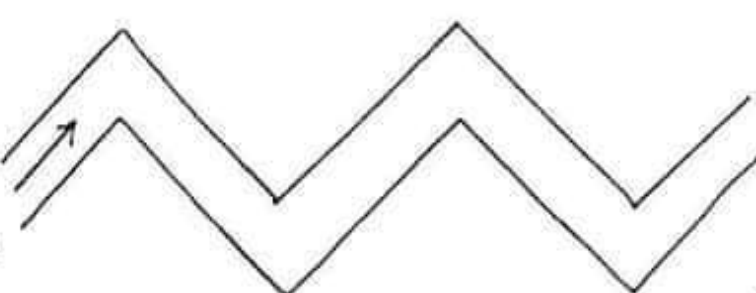
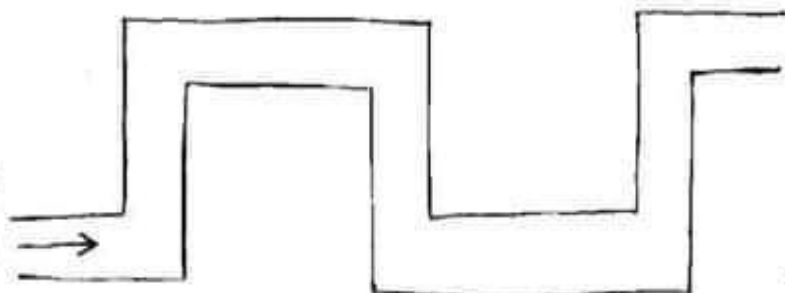

Проведи линии по дорожкам, не отрывая карандаш от бумаги и не выходя за края.

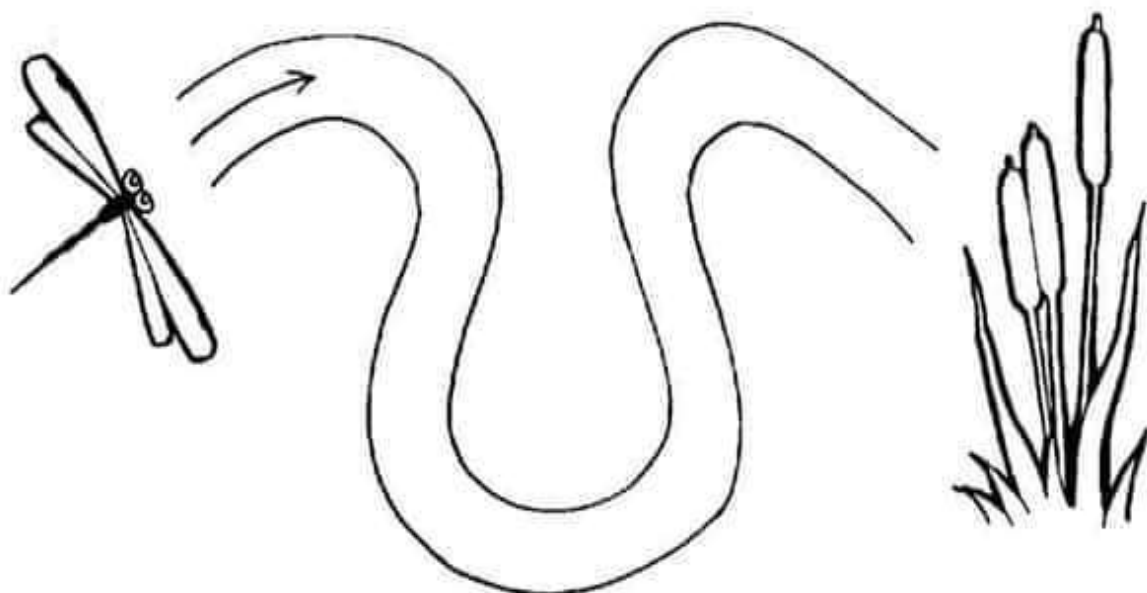
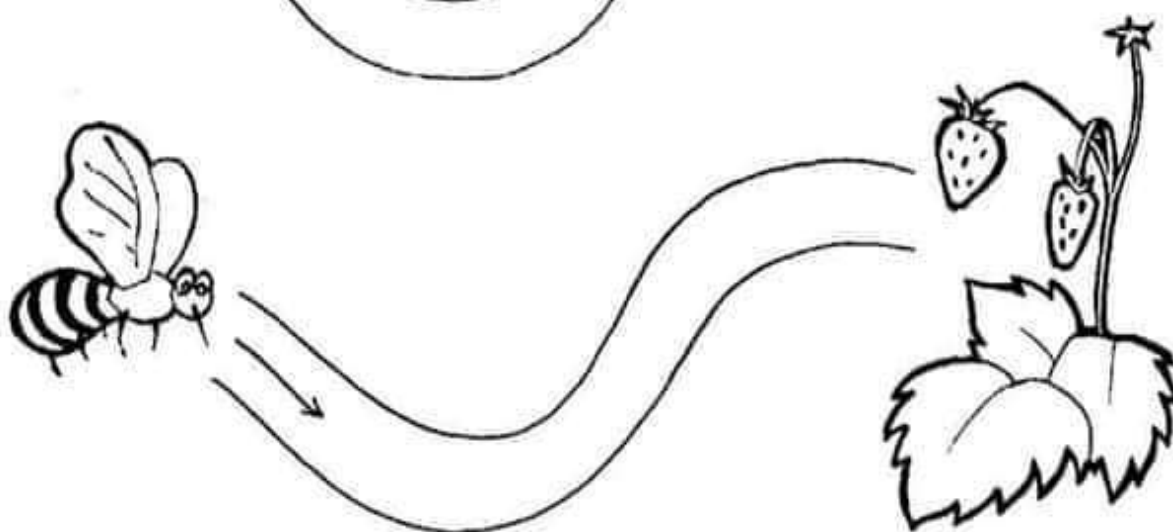
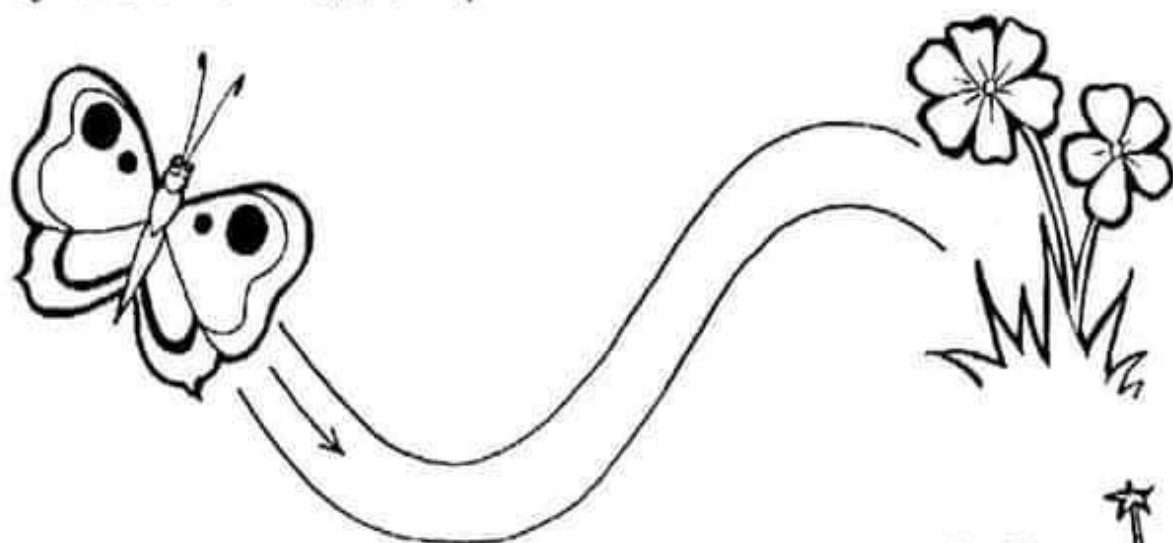

Помоги рыбкам доплыть до водорослей.

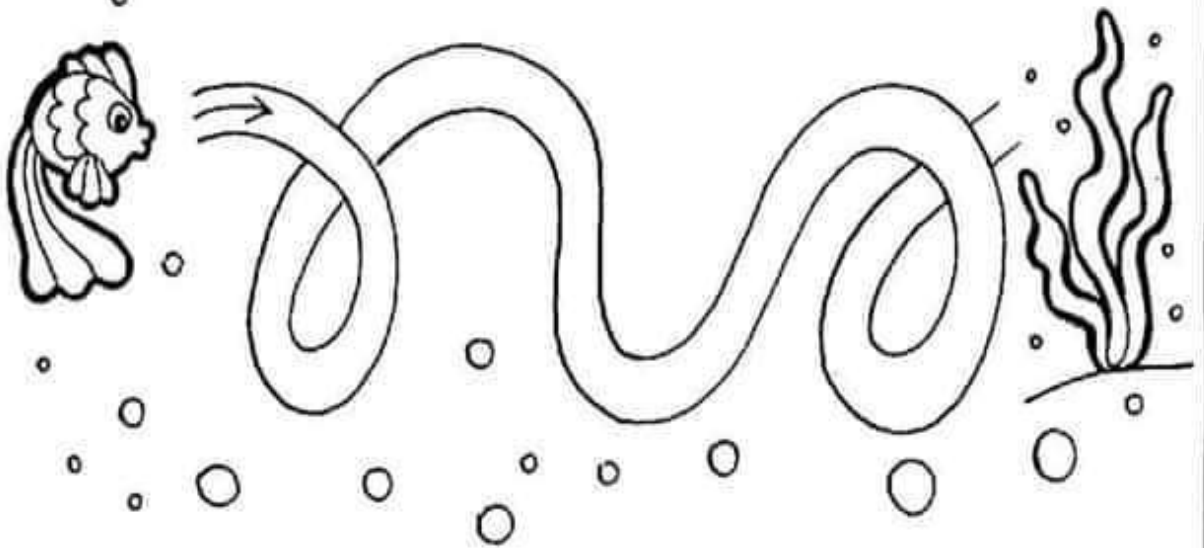
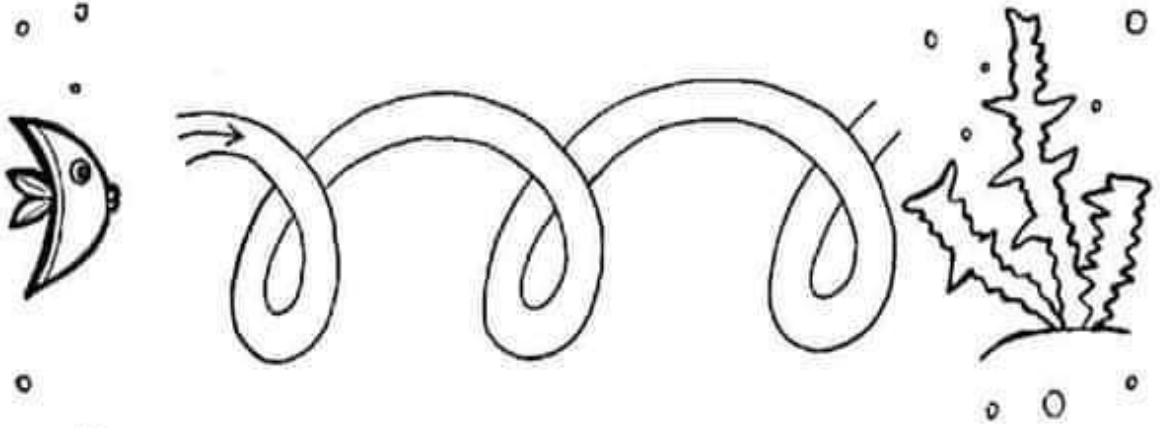
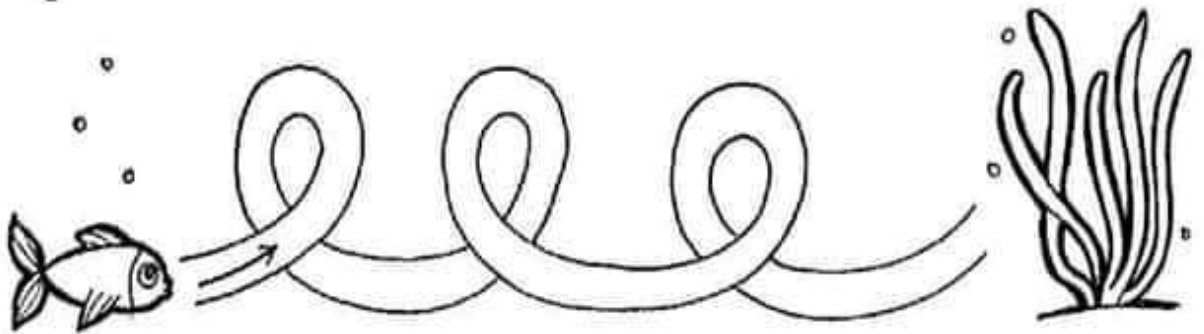
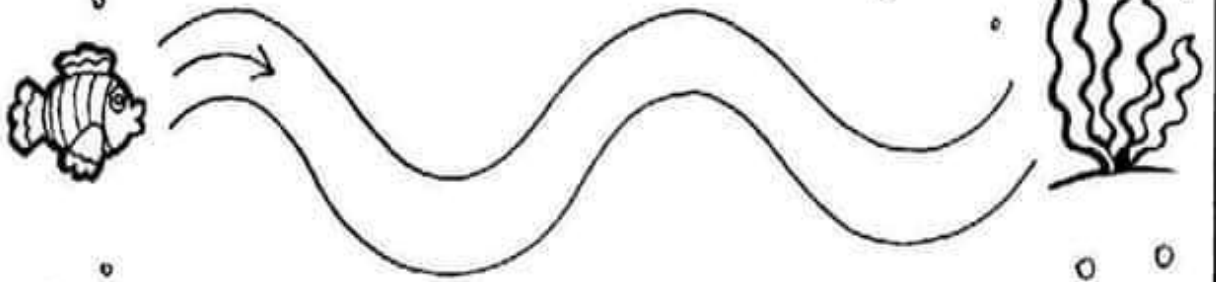

Помоги малышам пройти по дорожкам.

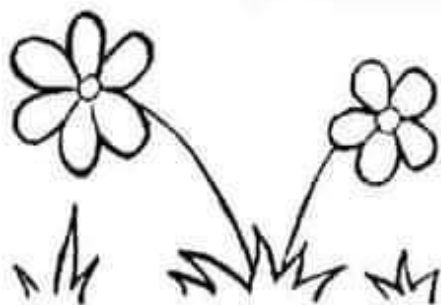
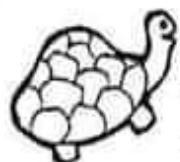



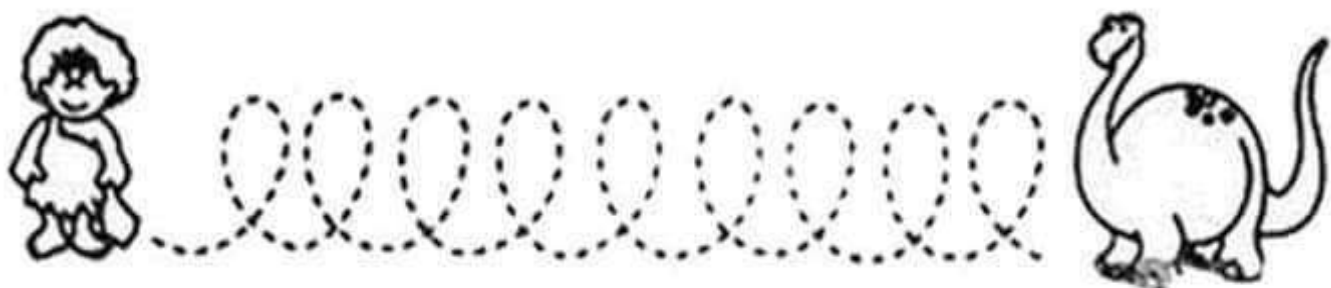
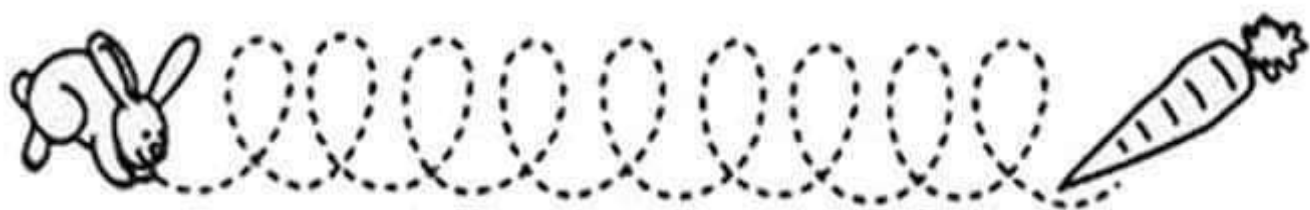
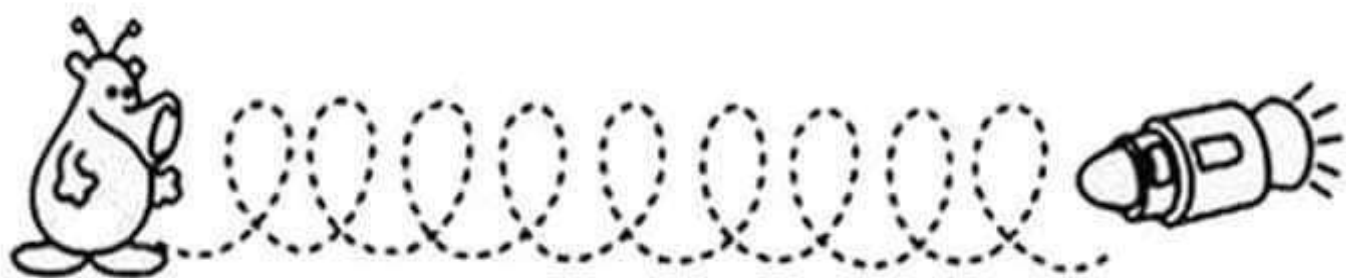
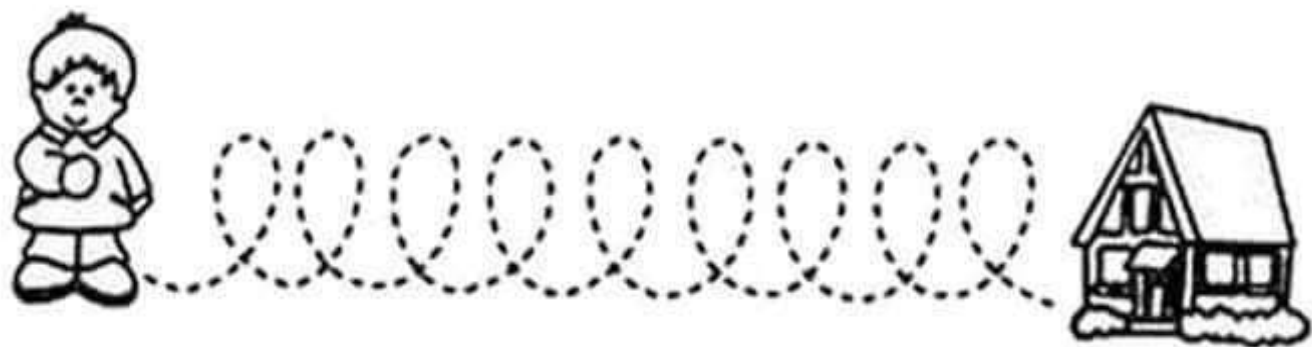

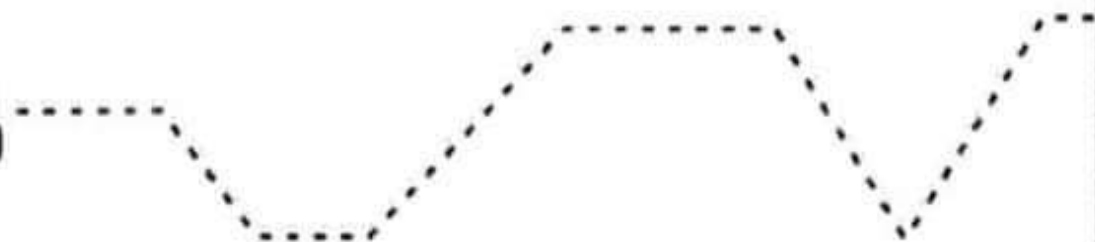
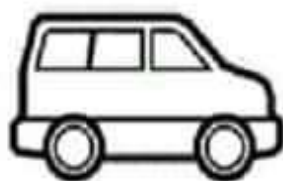
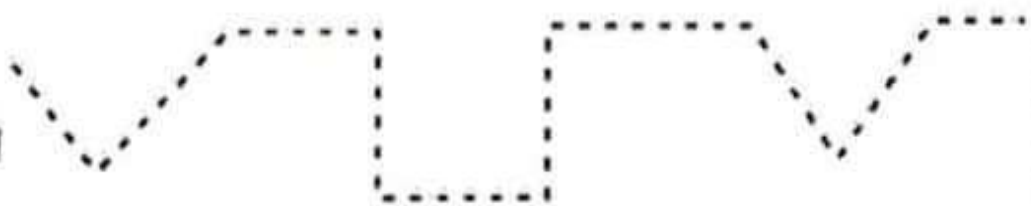



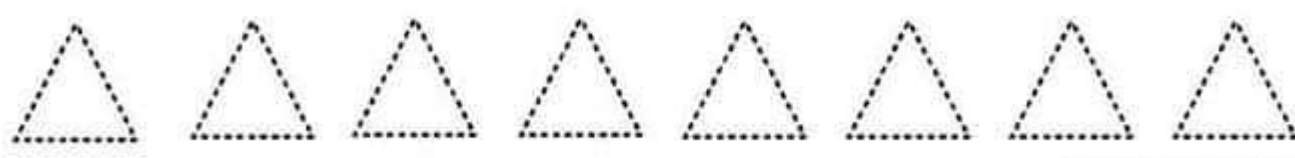
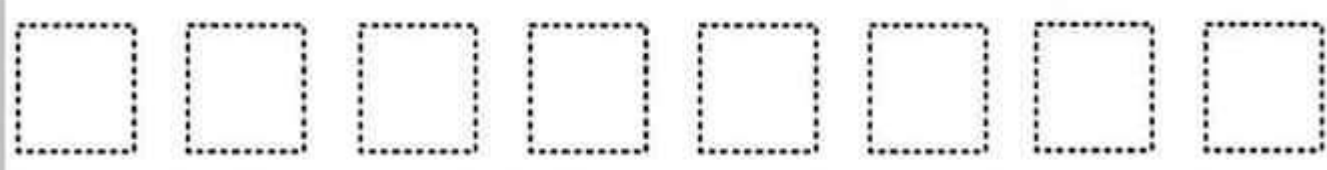
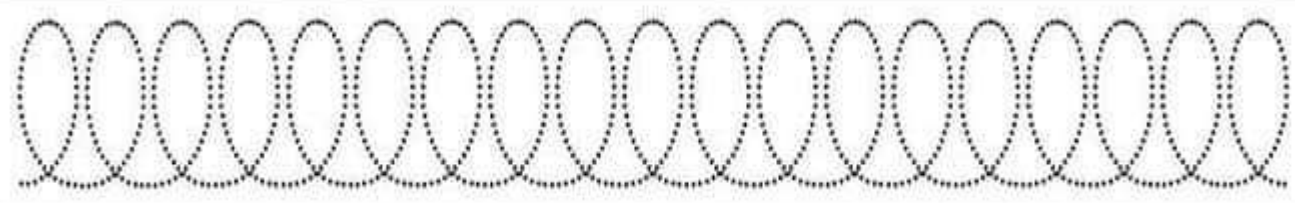
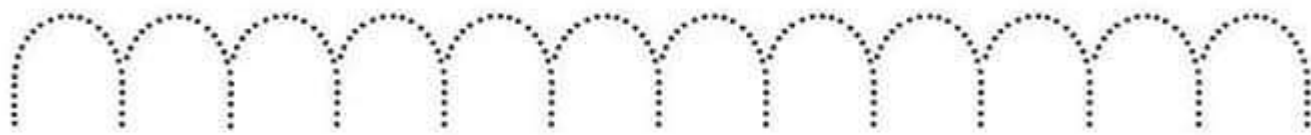
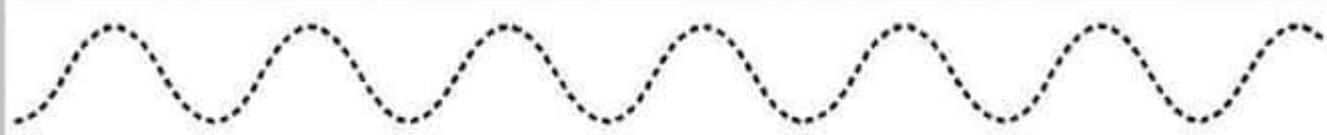
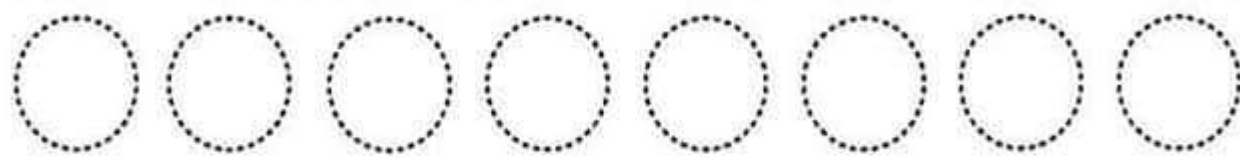
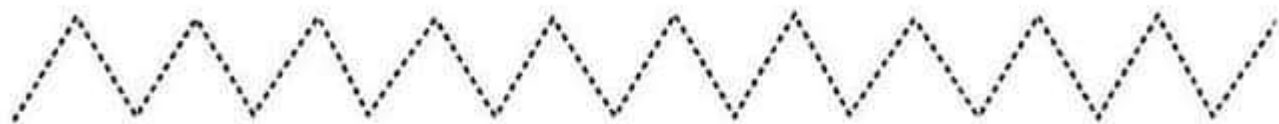

[www.fichte-maternelle.com](http://www.fichte-maternelle.com)

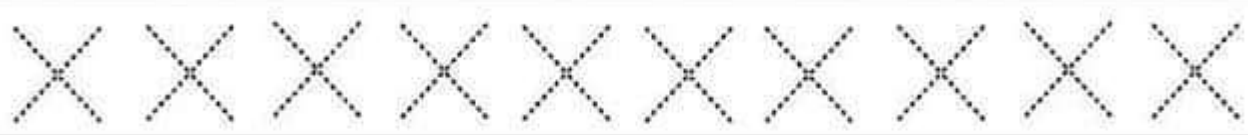
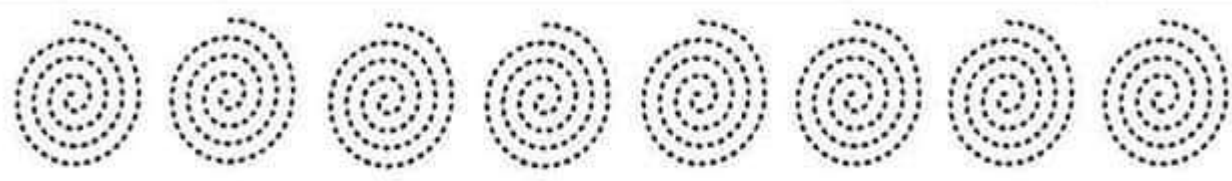



\_\_\_\_\_

\_\_\_\_\_

\_\_\_\_\_



\_\_\_\_\_

\_\_\_\_\_

\_\_\_\_\_



\_\_\_\_\_

\_\_\_\_\_

\_\_\_\_\_

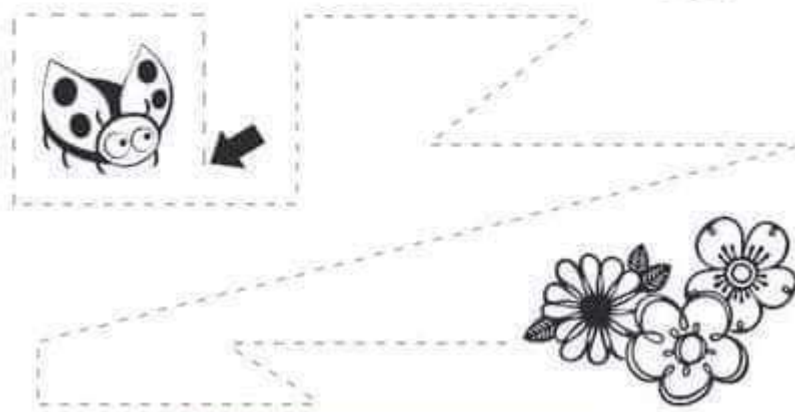
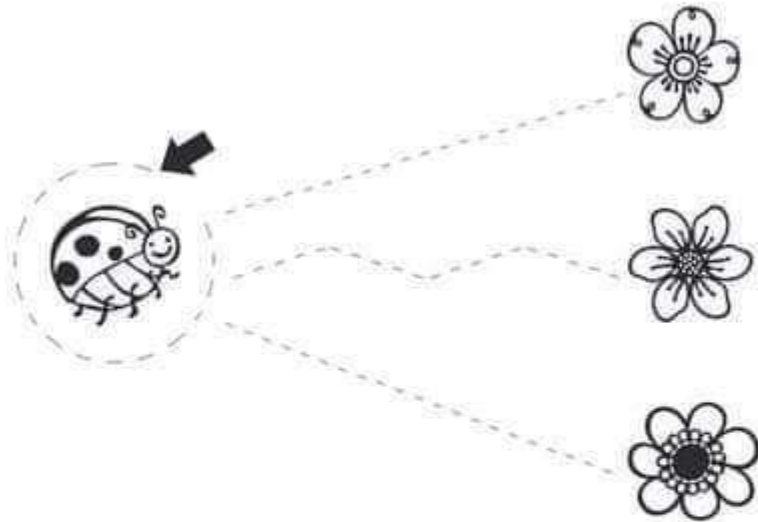

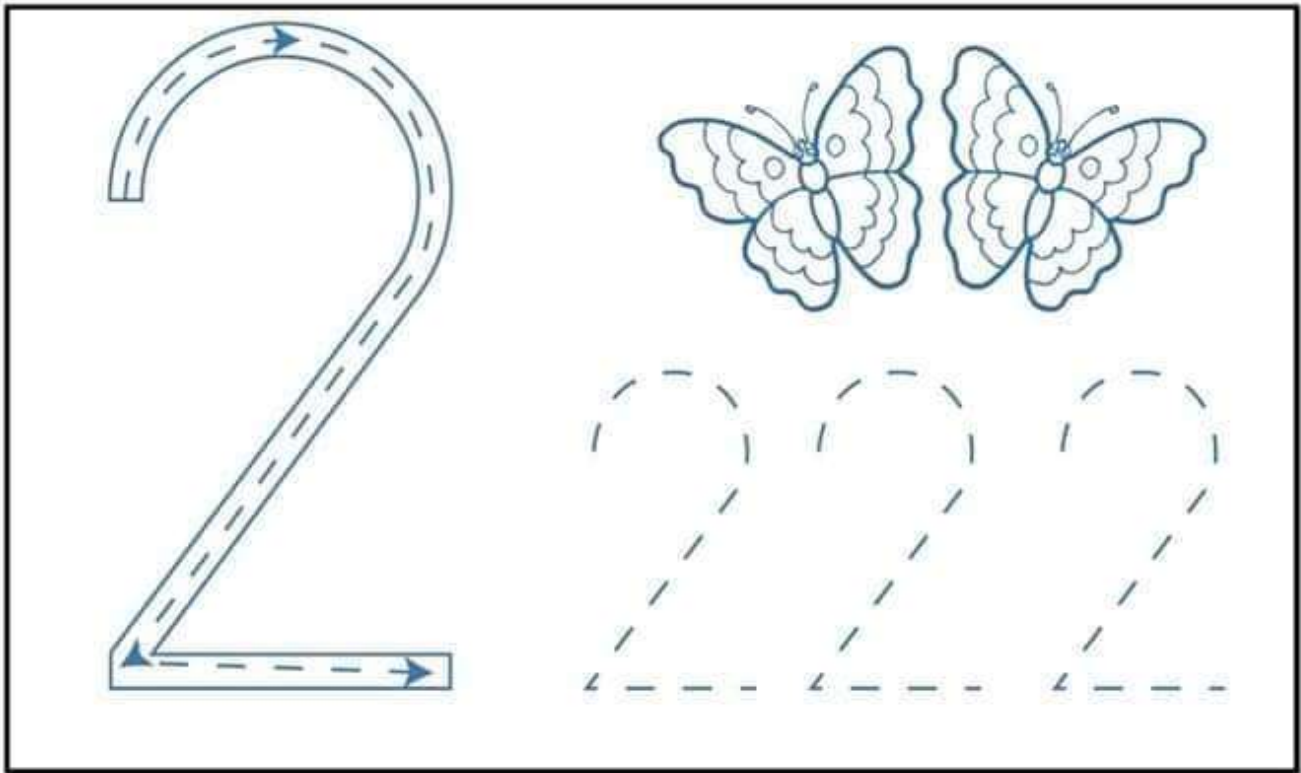
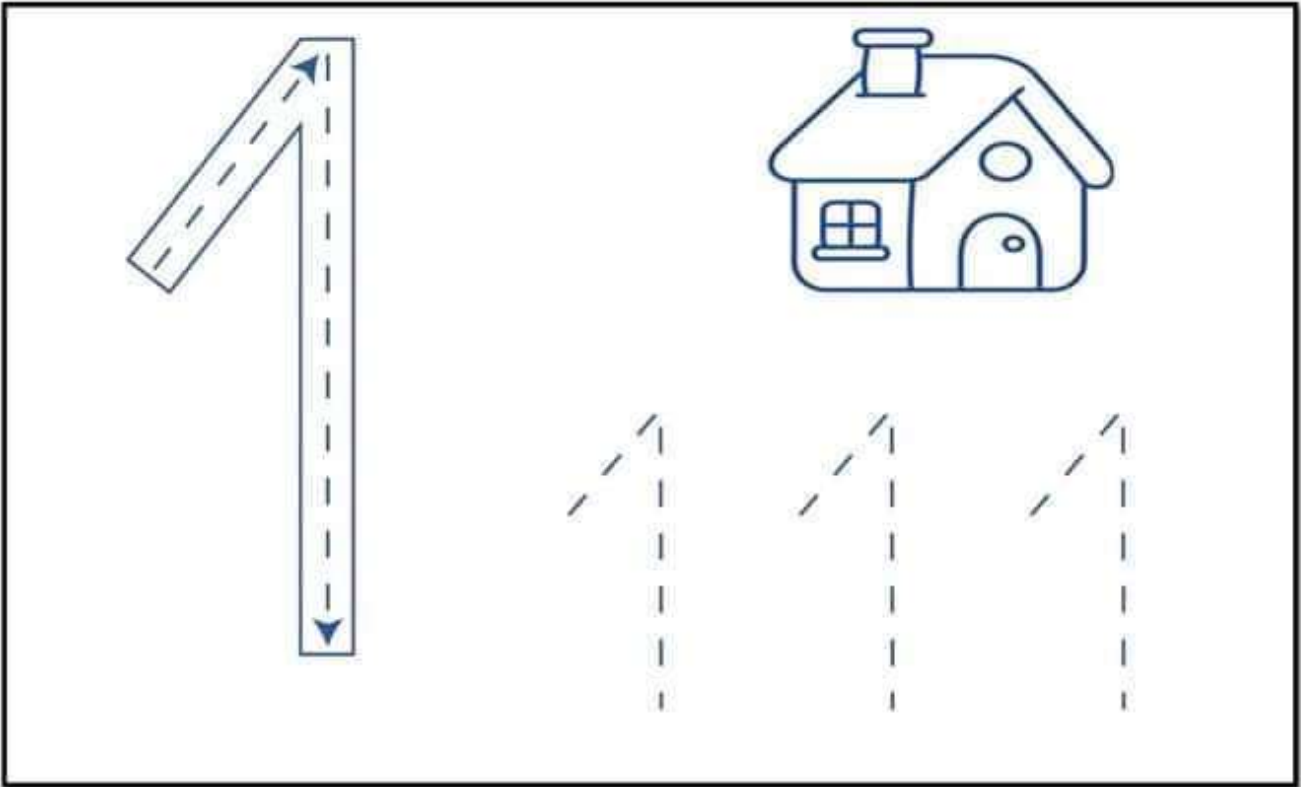

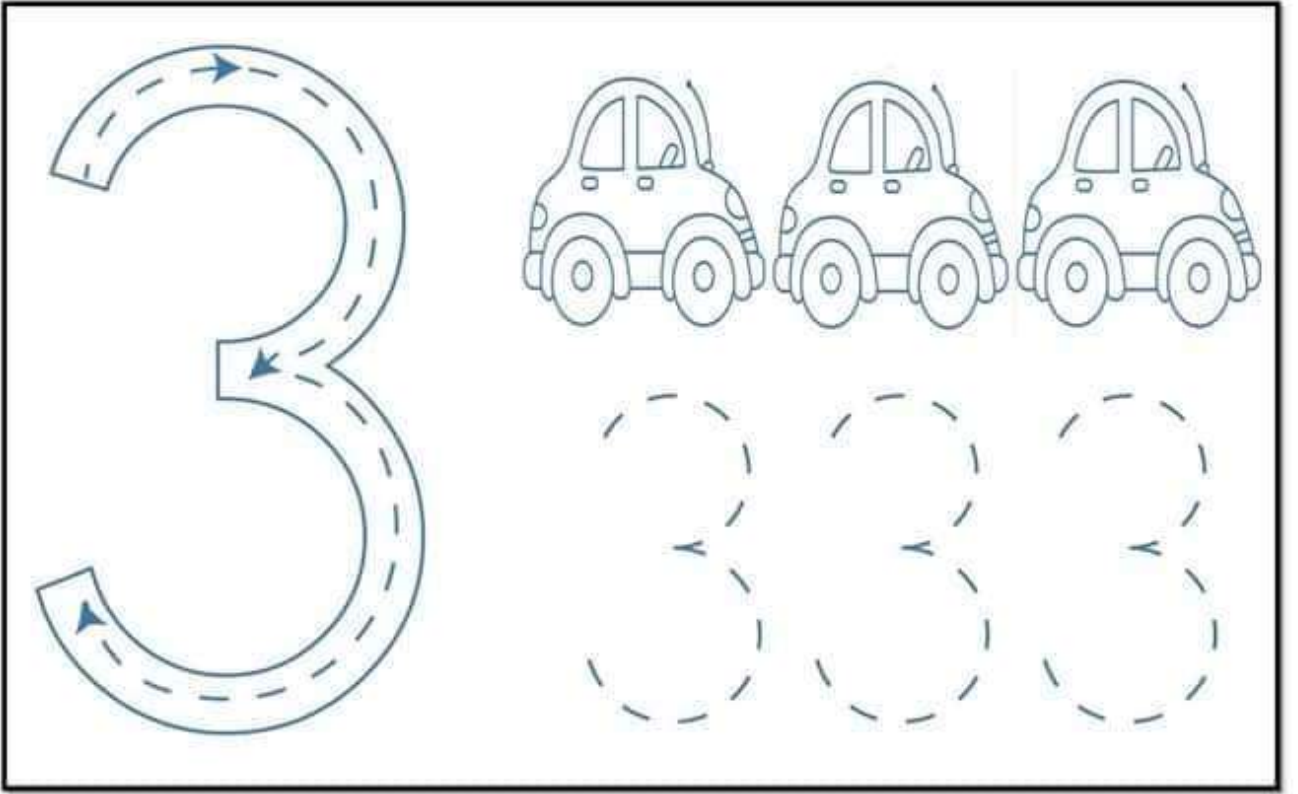

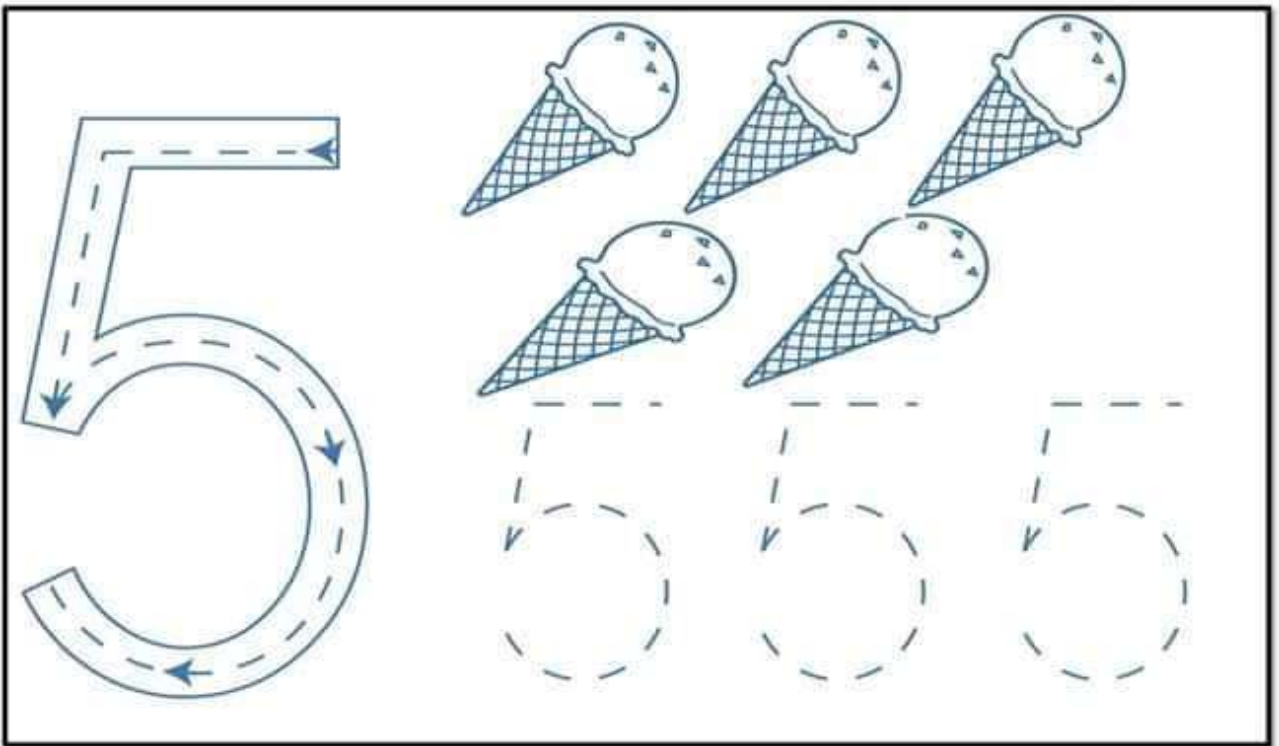
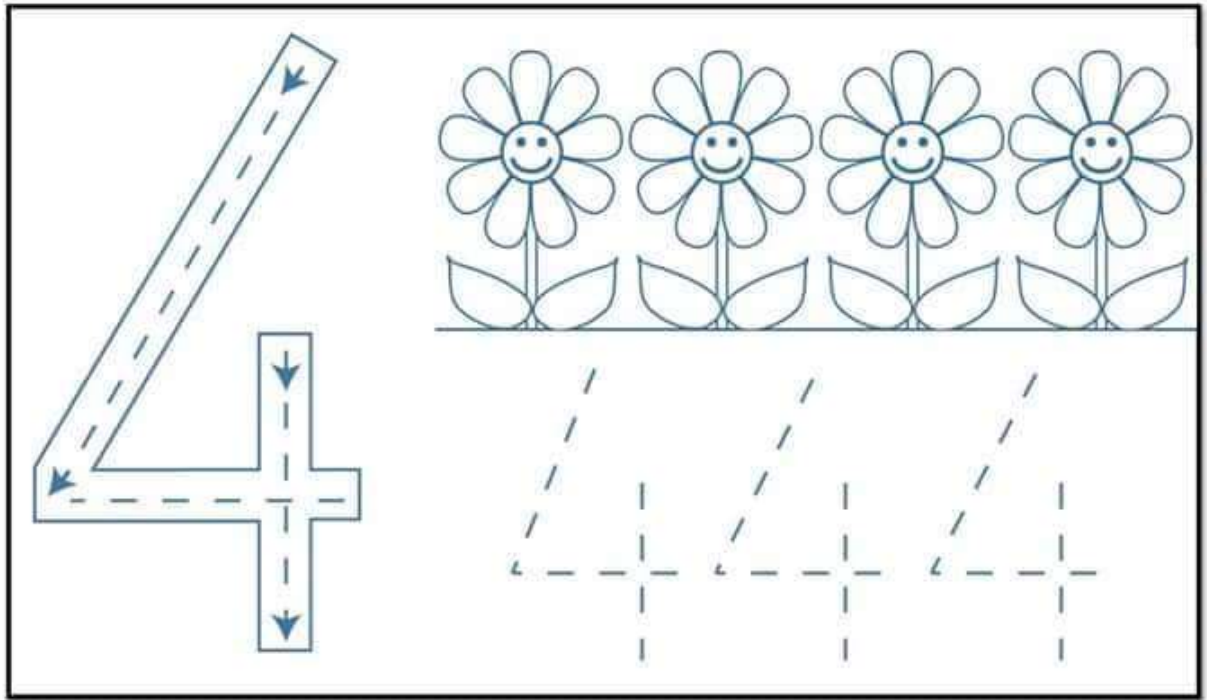



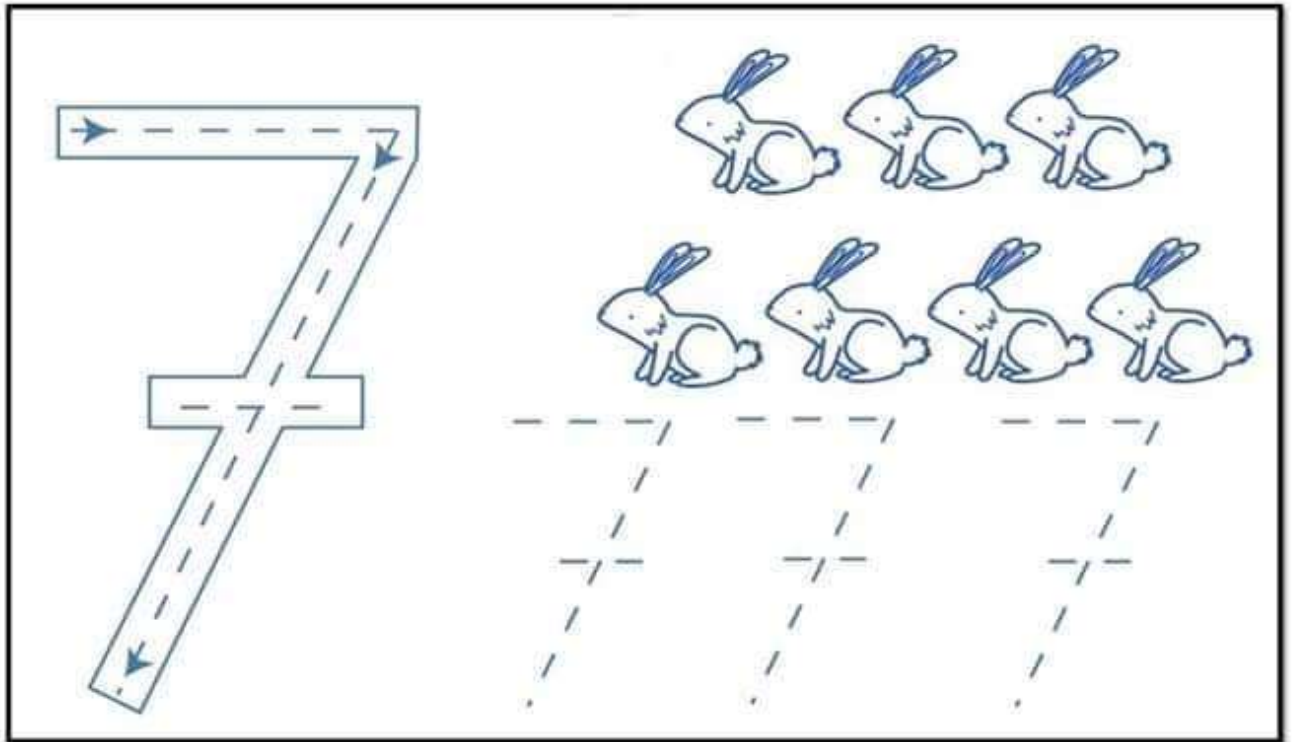
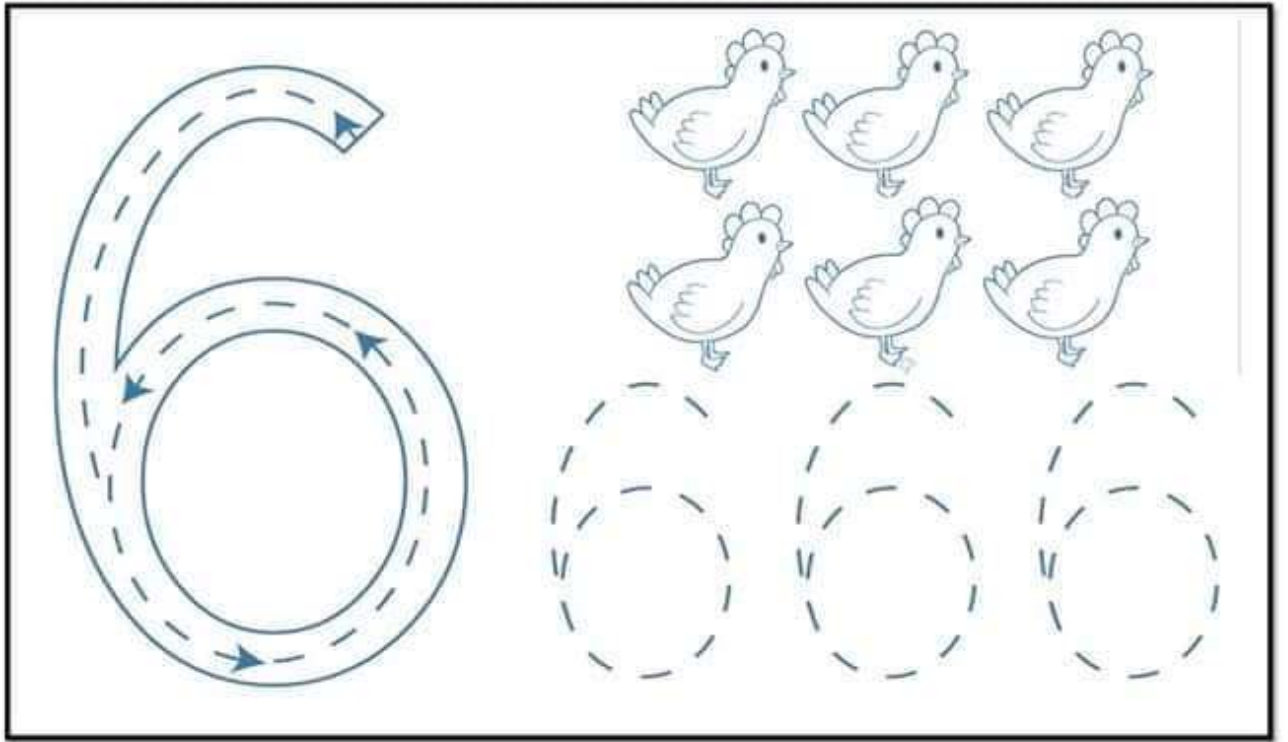

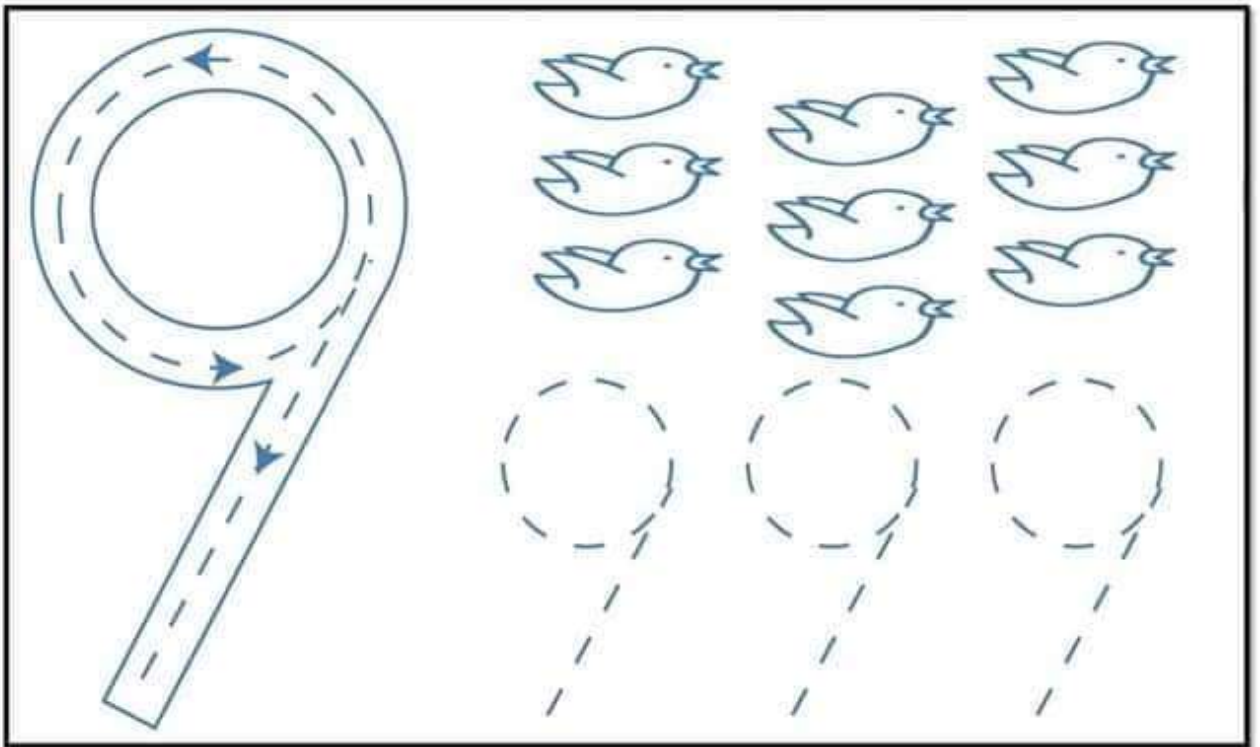
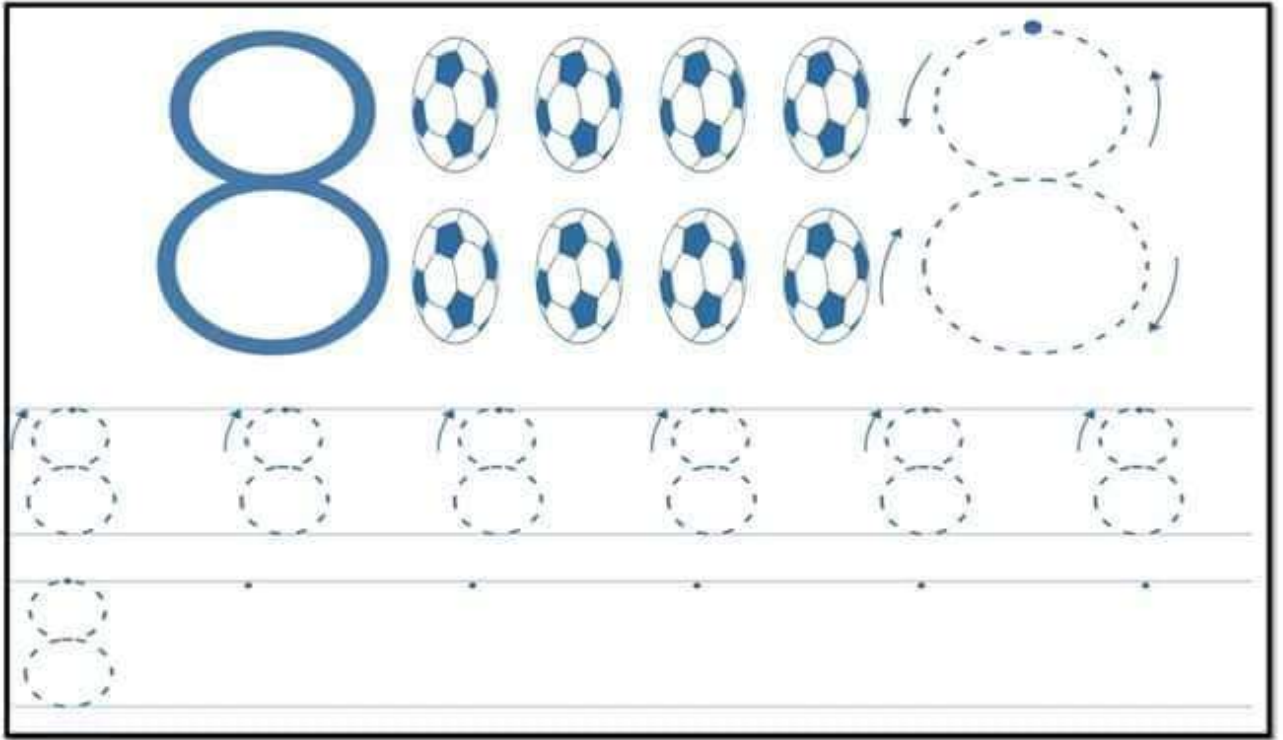

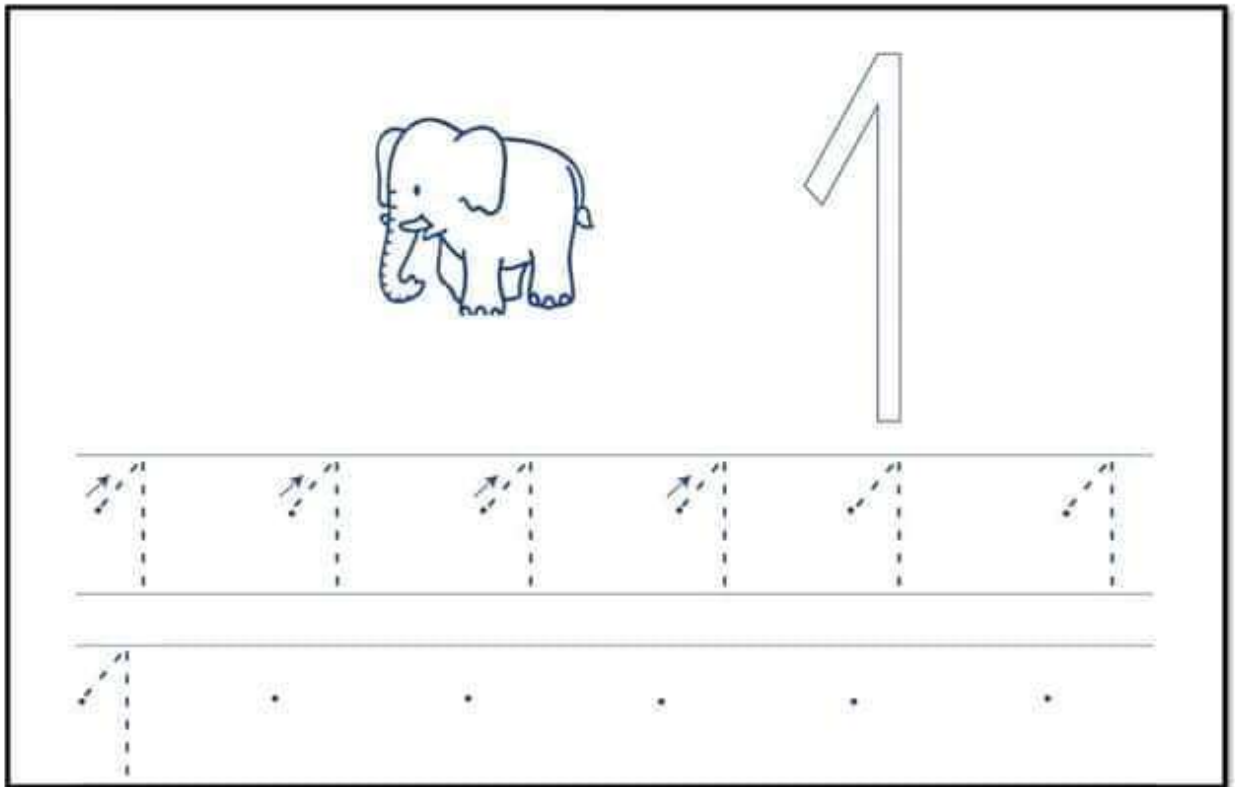

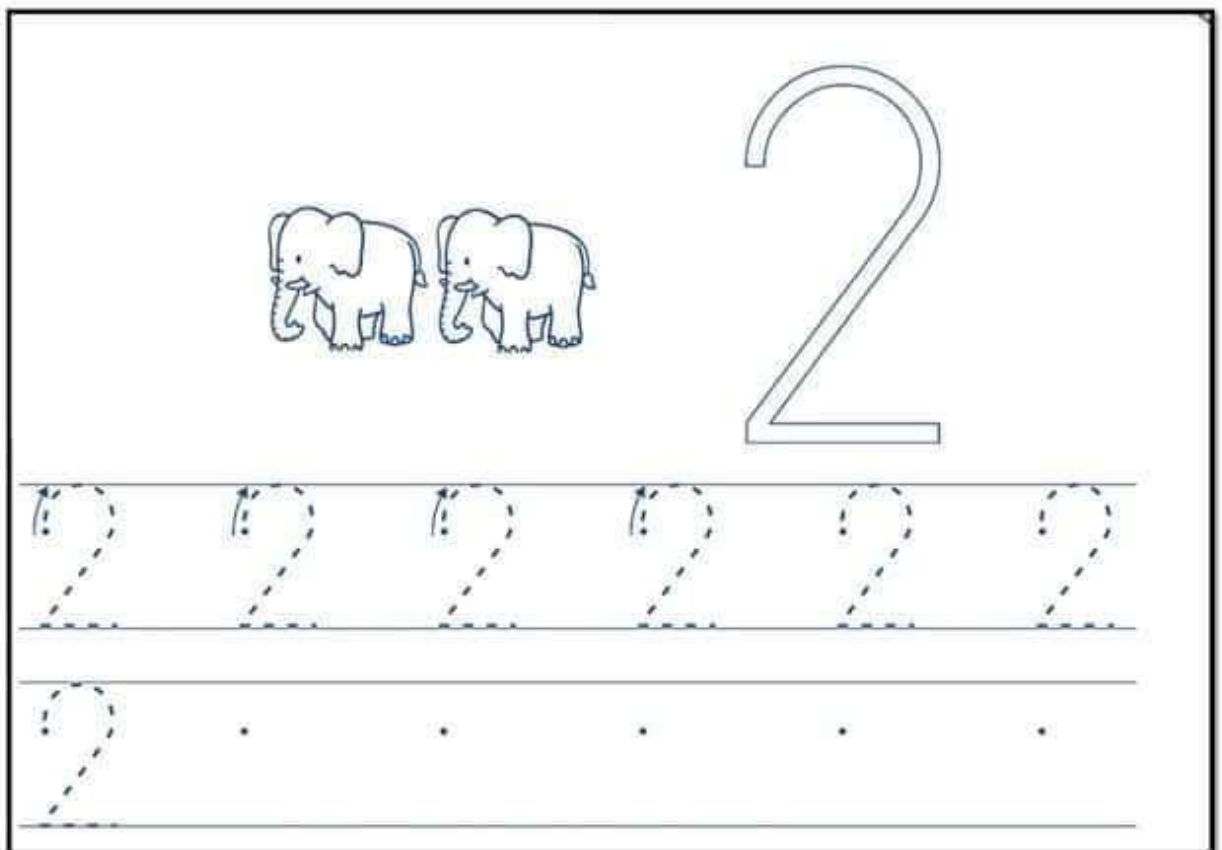

This section is designed for tracing the number 1. At the top left is a line drawing of a single elephant. To its right is a large, hollow outline of the number 1, with a small arrow at the top pointing downwards to indicate the starting point and direction of the stroke. Below these are two rows of handwriting lines. The first row contains six dashed outlines of the number 1, each with a small arrow at the top pointing downwards. The second row contains a dashed outline of the number 1 followed by five solid black dots, serving as starting points for independent practice.



This section is designed for tracing the number 2. At the top left is a line drawing of two elephants. To their right is a large, hollow outline of the number 2, with a small arrow at the top pointing downwards to indicate the starting point and direction of the stroke. Below these are two rows of handwriting lines. The first row contains six dashed outlines of the number 2, each with a small arrow at the top pointing downwards. The second row contains a dashed outline of the number 2 followed by five solid black dots, serving as starting points for independent practice.

3 3 3 3



3 3 3 3 3 3

3 . . . . .

4 4 4 4

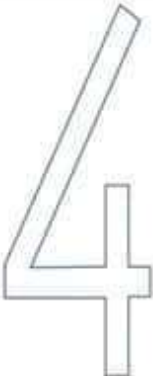
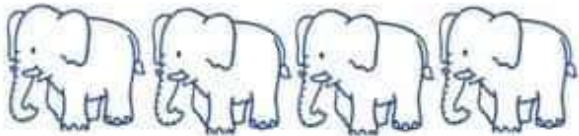

4 4 4 4 4 4

4 . . . . .

5



5 5 5 5 5 5

5 . . . . .

This section is for learning the number 5. It features a large outline of the number 5 at the top right. To its left is a row of five line-art elephants. Below this, there are two rows of handwriting practice lines. The first row contains six dashed number 5s, each with a small arrow at the top left indicating the starting point and direction of the stroke. The second row contains one dashed number 5 followed by five dots, each positioned at the start of a new line.

6

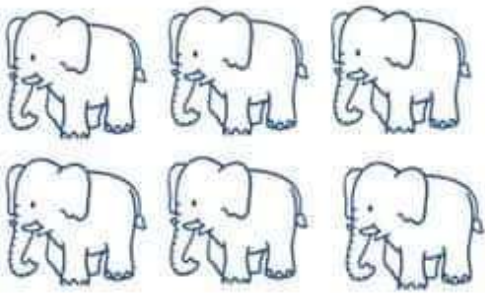

6 6 6 6 6 6

6 . . . . .

This section is for learning the number 6. It features a large outline of the number 6 at the top right. To its left is a 2x3 grid of six line-art elephants. Below this, there are two rows of handwriting practice lines. The first row contains six dashed number 6s, each with a small arrow at the top left indicating the starting point and direction of the stroke. The second row contains one dashed number 6 followed by five dots, each positioned at the start of a new line.

7

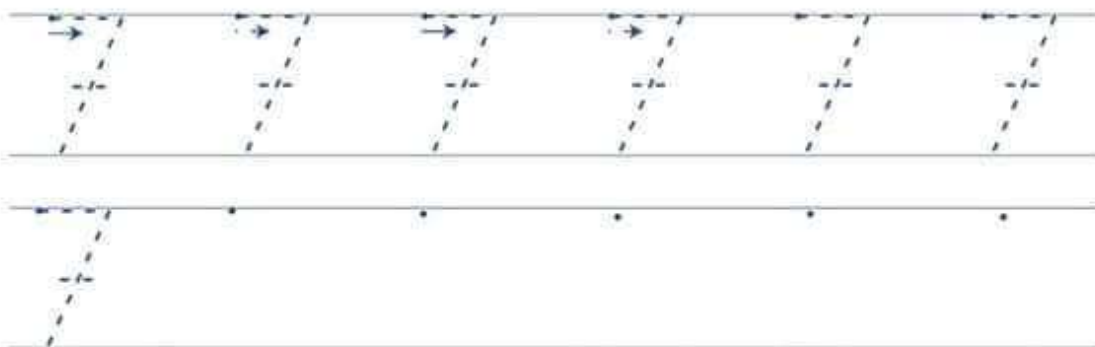
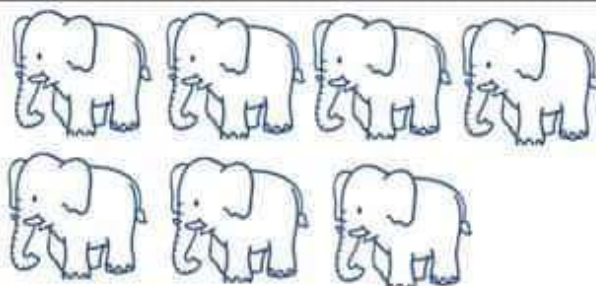

8

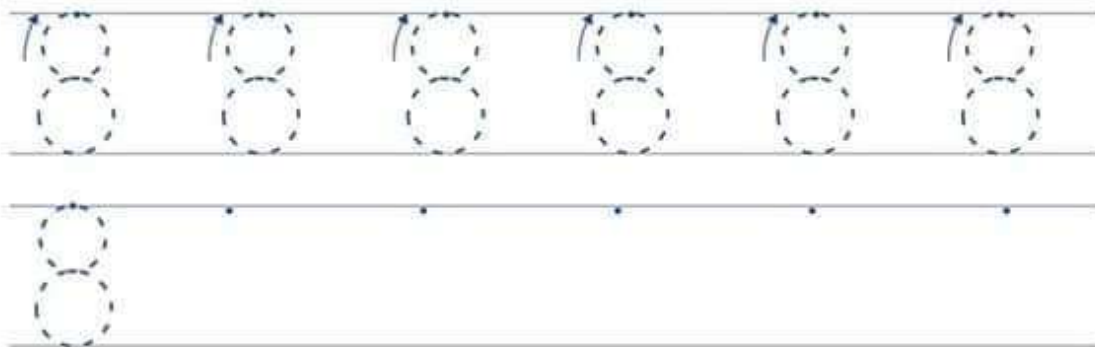
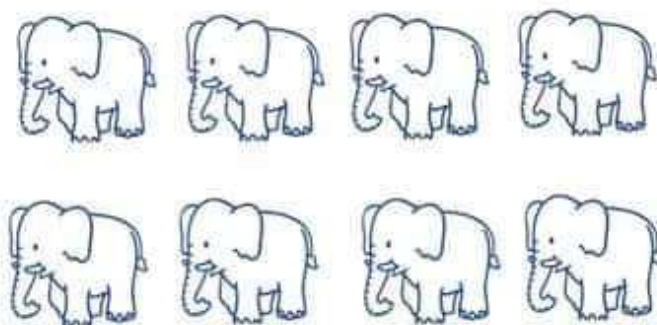

9

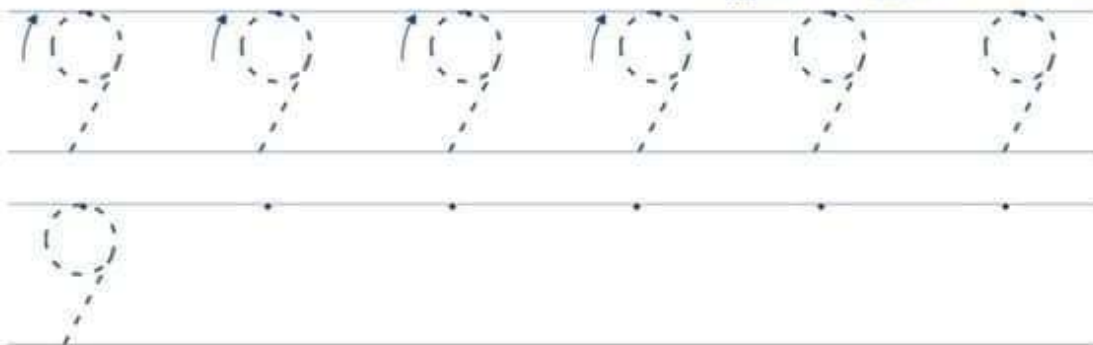
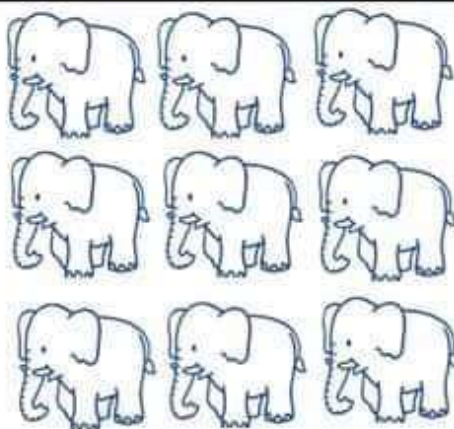

1

0 0 0 0 0



1 1 1 1 1



2 2 2 2 2



3 3 3 3 3



4 4 4 4 4

5 5 5 5 5

6 6 6 6 6

7 7 7 7 7

8 8 8 8 8

9 9 9 9 9



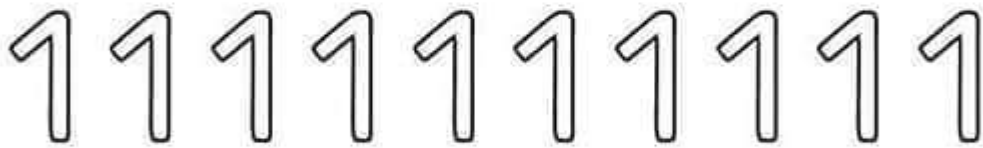
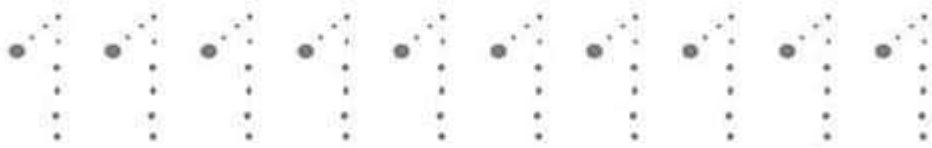
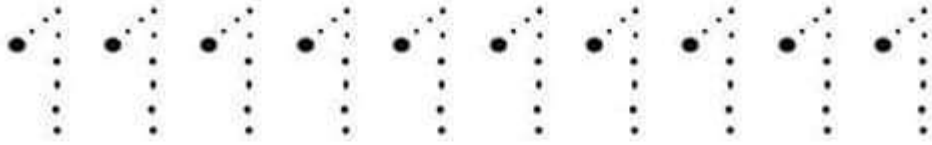
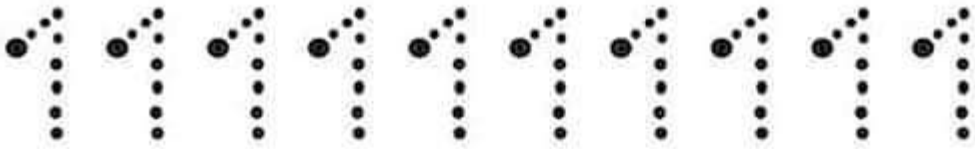



22222222

22222222

22222222

22222222

22222222

22222222

22222222222222

22222222222222



3 3 3 3 3 3 3 3 3

3 3 3 3 3 3 3 3 3

3 3 3 3 3 3 3 3 3

3 3 3 3 3 3 3 3 3

3 3 3 3 3 3 3 3 3 3

3 3 3 3 3 3 3 3 3 3 3 3

3 3 3 3 3 3 3 3 3 3 3 3 3 3 3

3 3 3 3 3 3 3 3 3 3 3 3 3 3 3 3 3

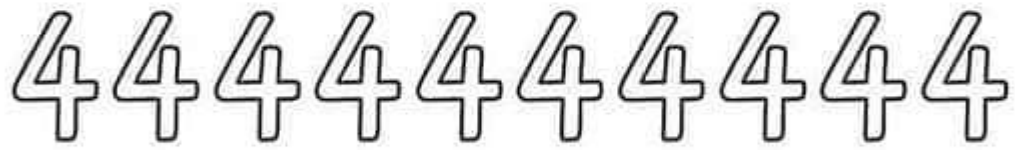
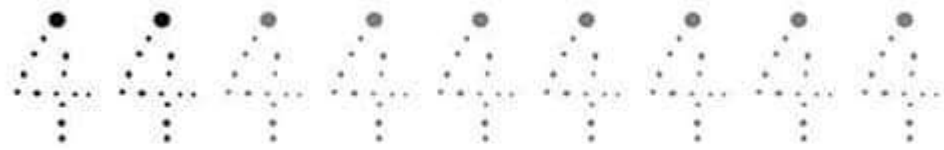
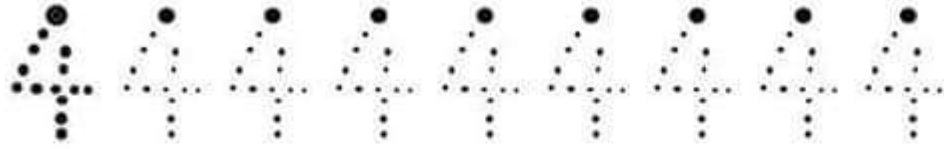
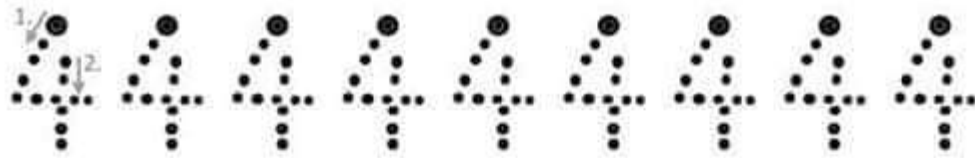

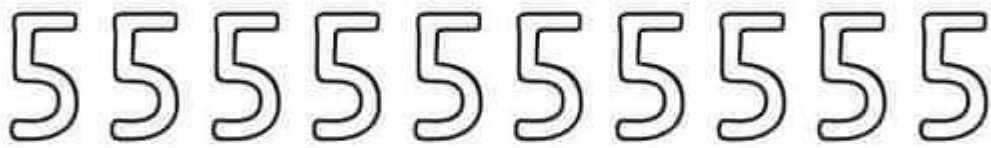
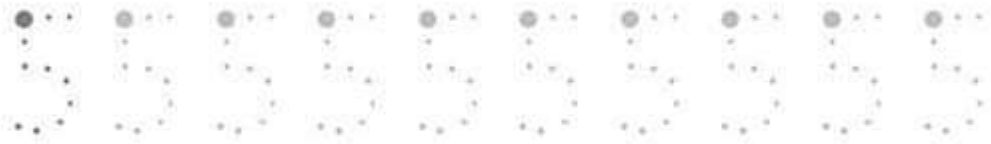
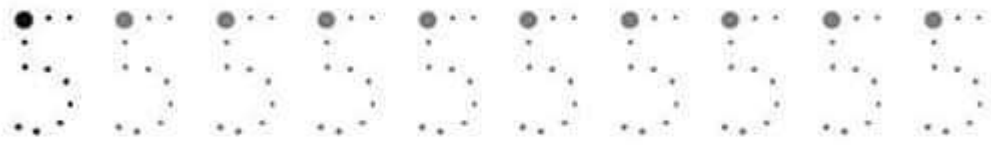
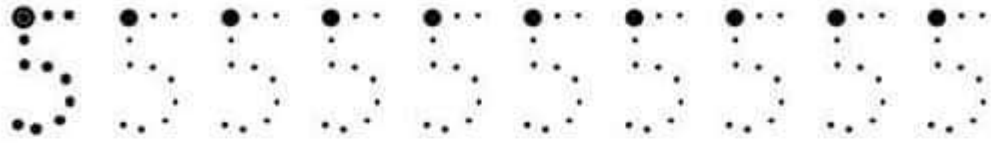
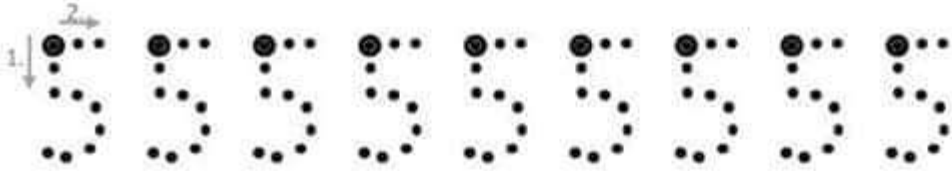

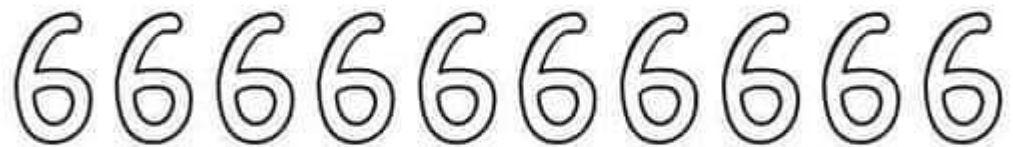
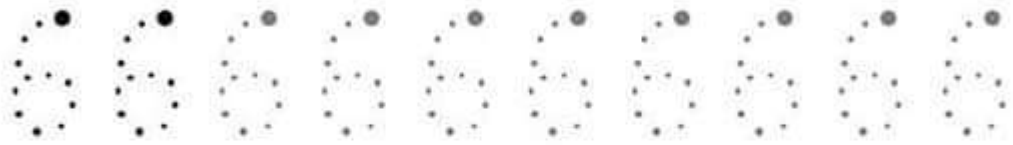
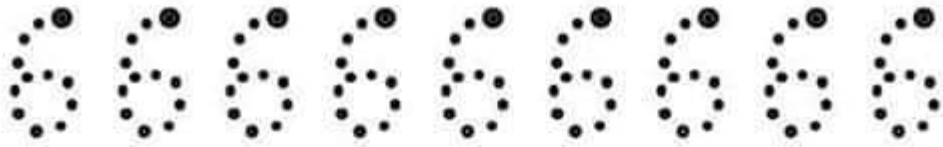

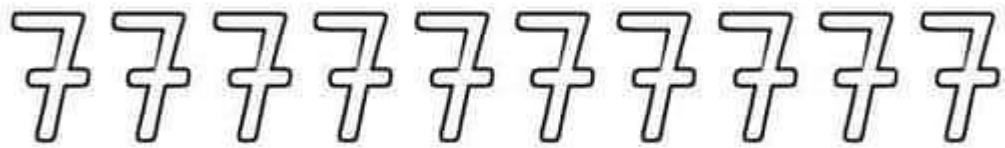
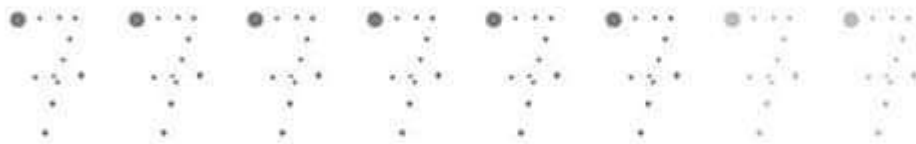
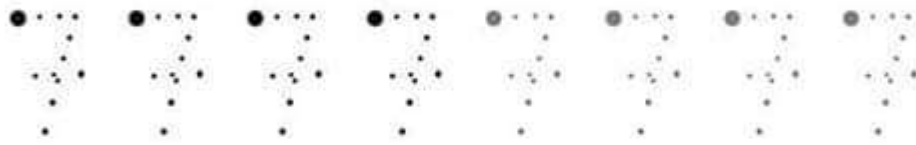
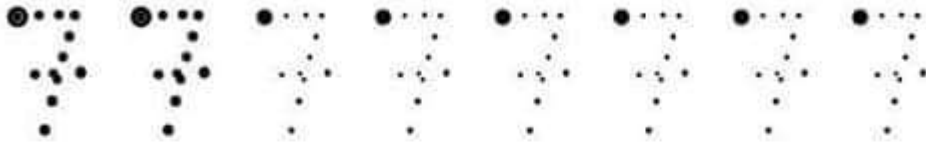
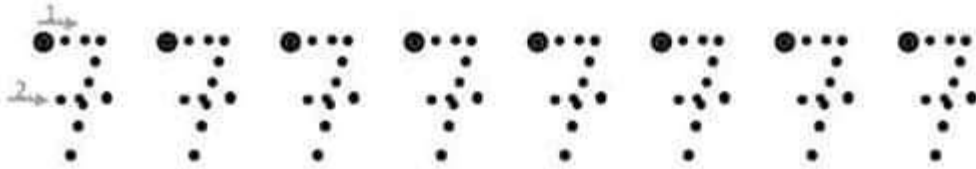

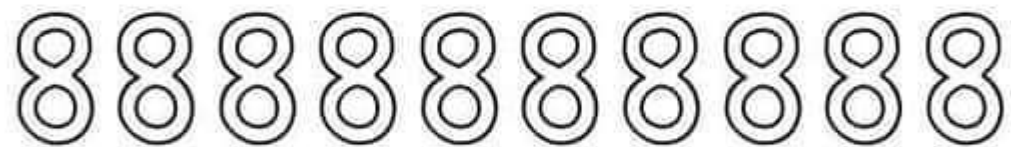
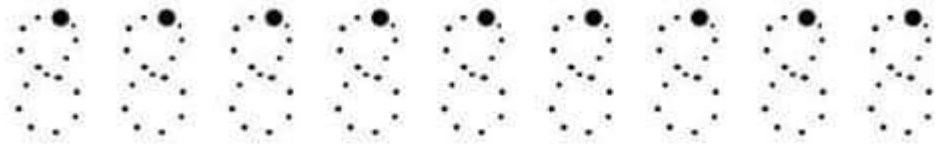
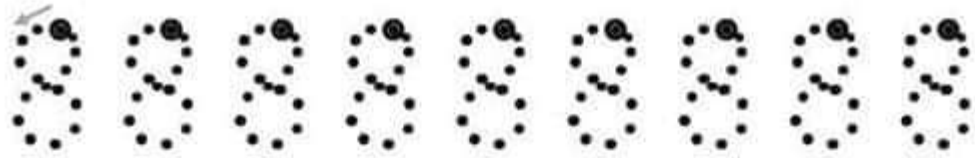



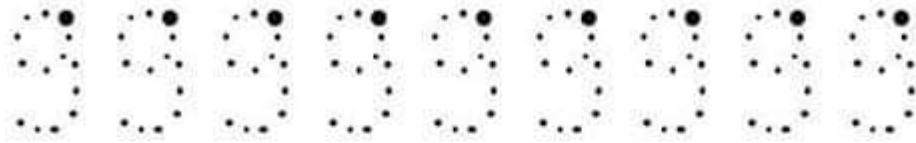
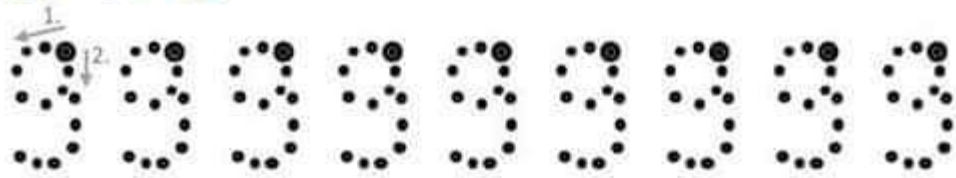

Escola \_\_\_\_\_

Professor(a): \_\_\_\_\_ Data: \_\_\_/\_\_\_/\_\_\_

Aluno(a): \_\_\_\_\_

Aprendendo a recortar:

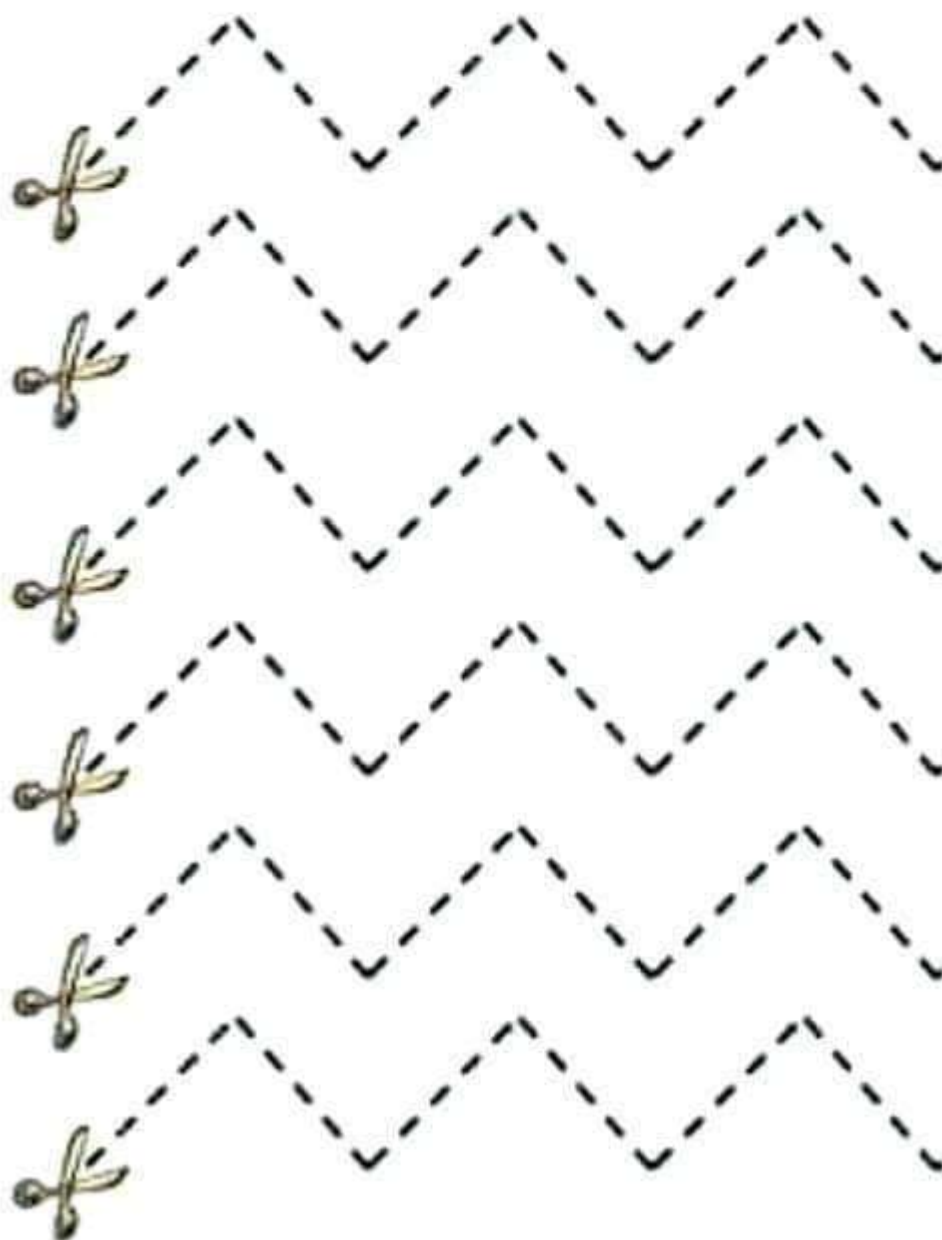

Escola \_\_\_\_\_

Professor(a): \_\_\_\_\_ Data: \_\_/\_\_/\_\_

Aluno(a): \_\_\_\_\_

Aprendendo a recortar:

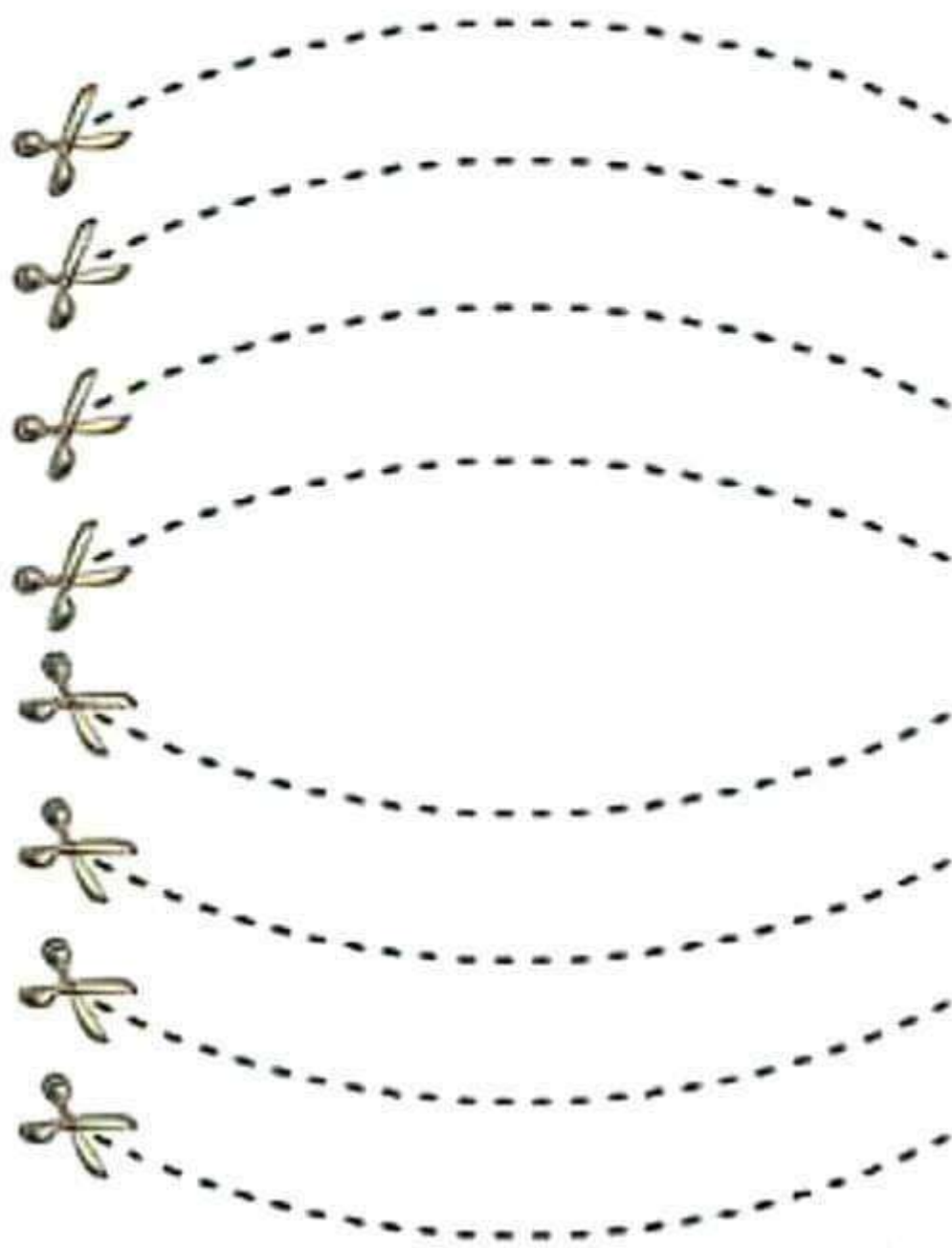

Escola \_\_\_\_\_

Professor(a): \_\_\_\_\_ Data: \_\_/\_\_/\_\_

Aluno(a): \_\_\_\_\_

Aprendendo a recortar:

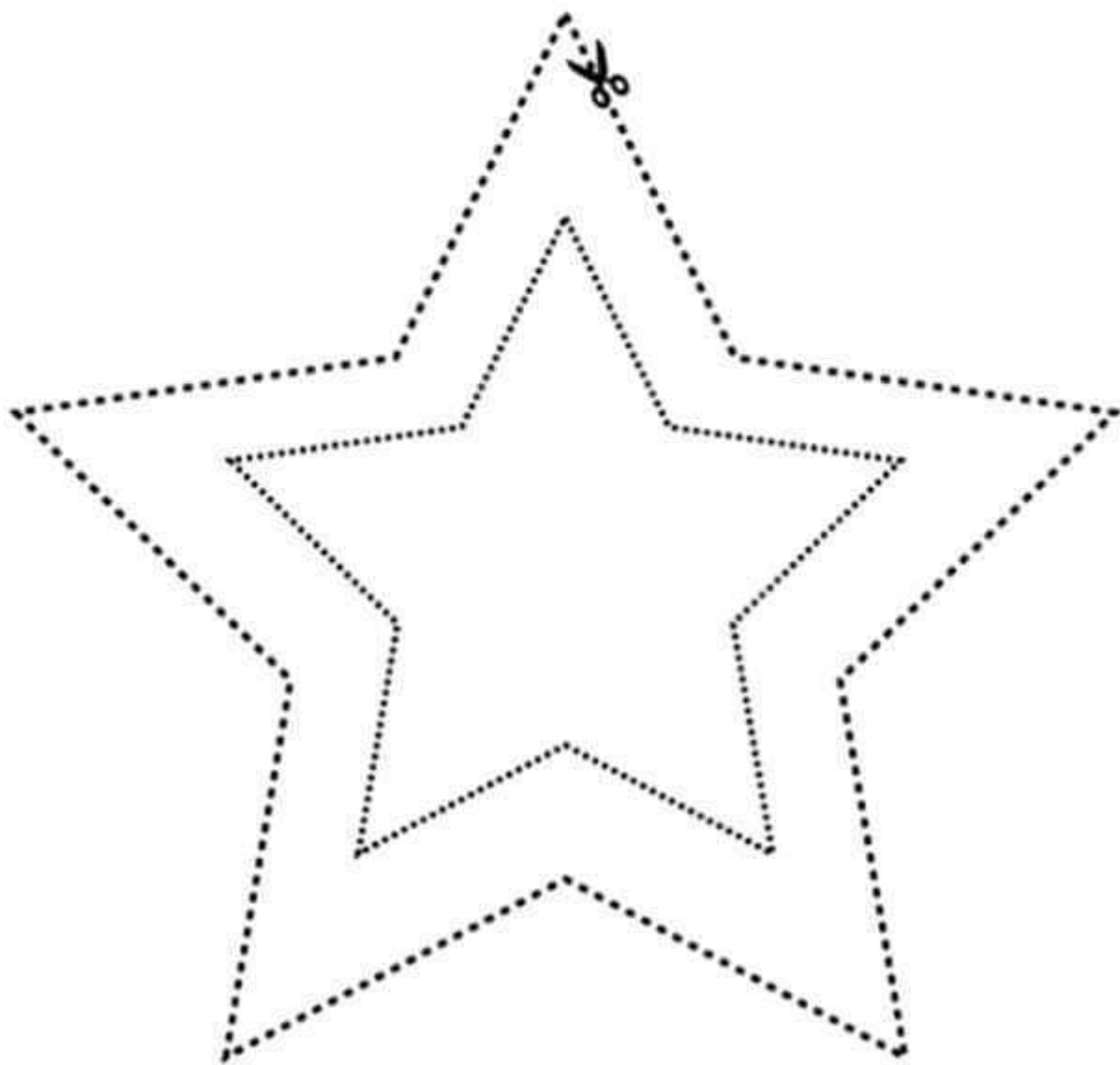

Escola \_\_\_\_\_

Professor(a): \_\_\_\_\_ Data: \_\_\_/\_\_\_/\_\_\_

Aluno(a): \_\_\_\_\_

Aprendendo a recortar:

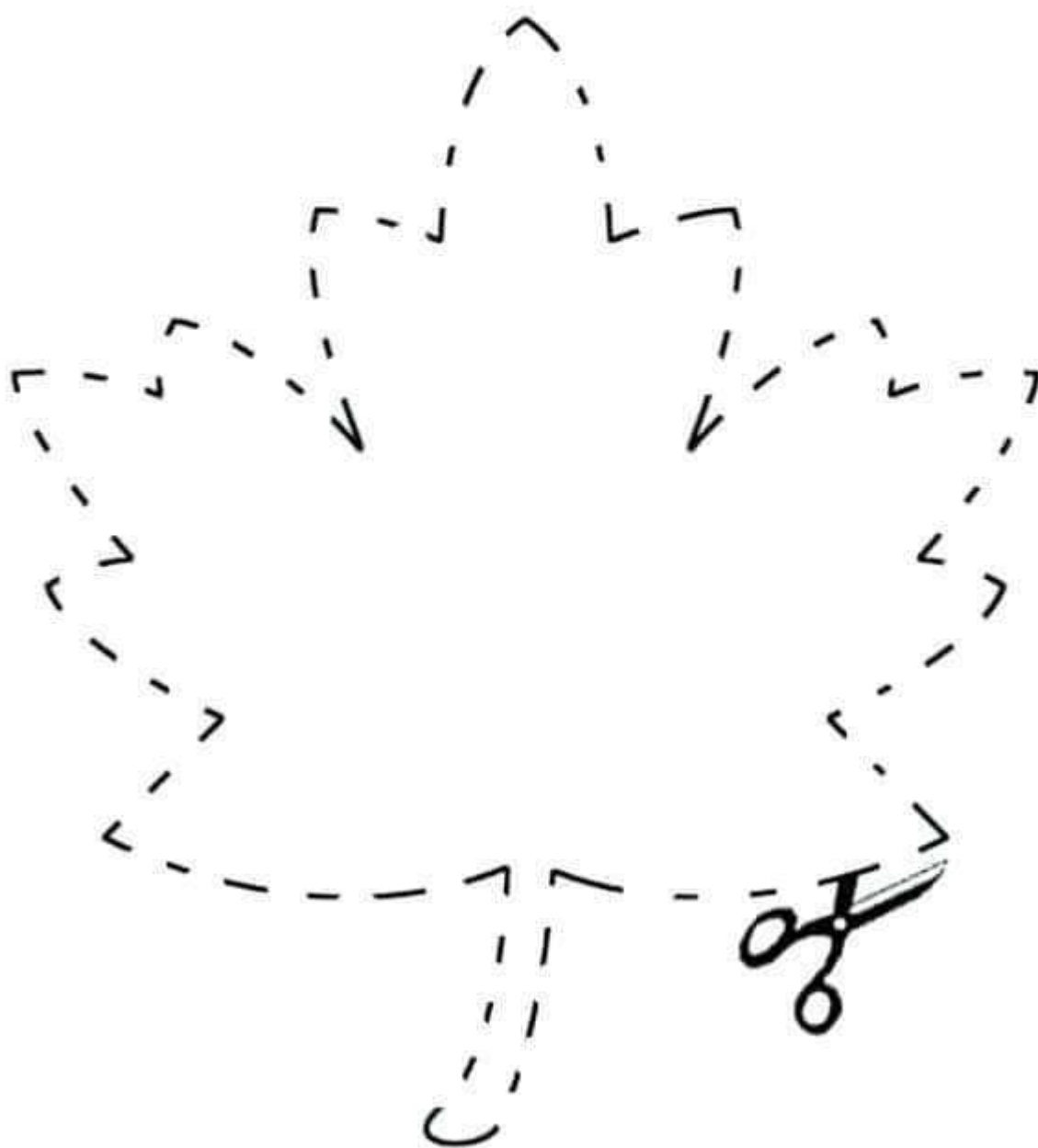

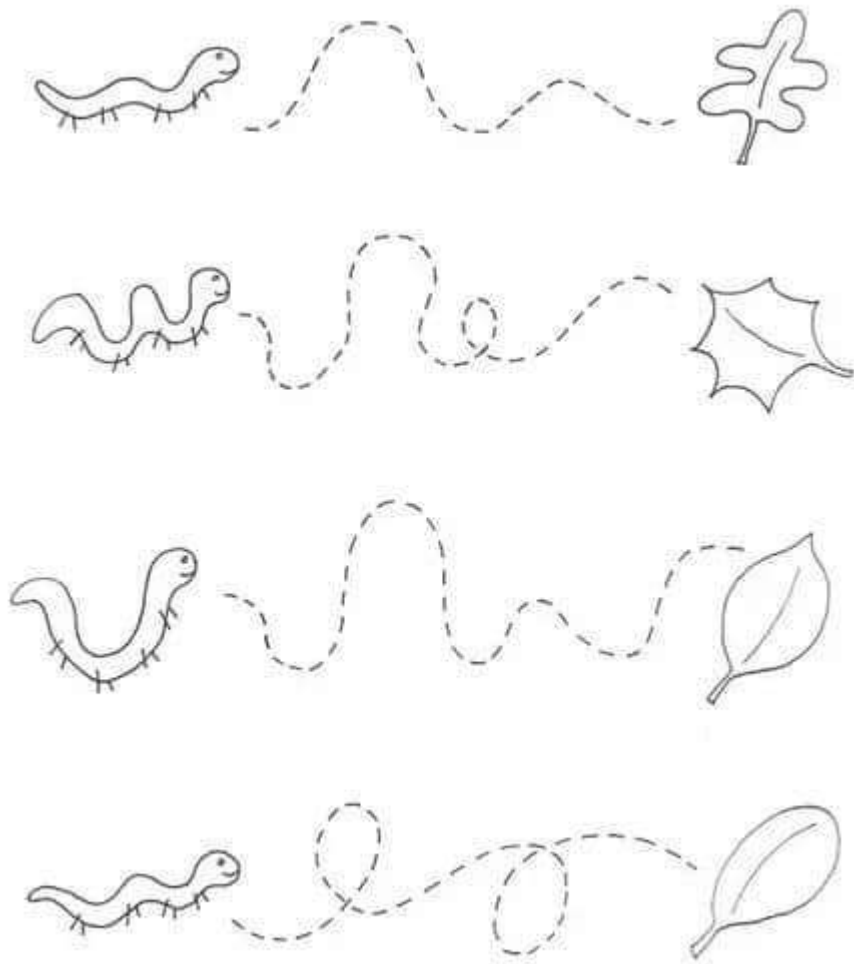

## Where is my home?



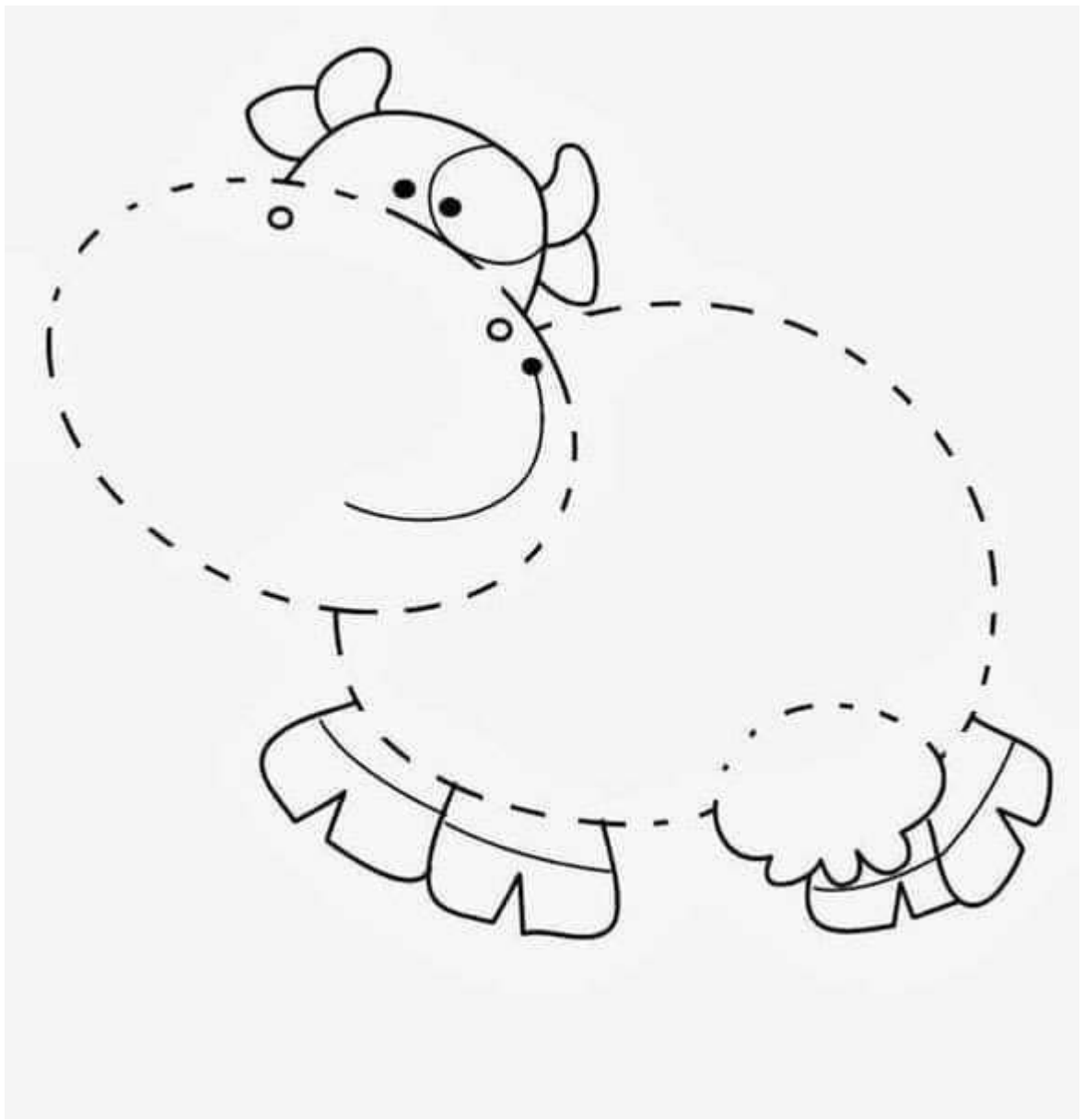

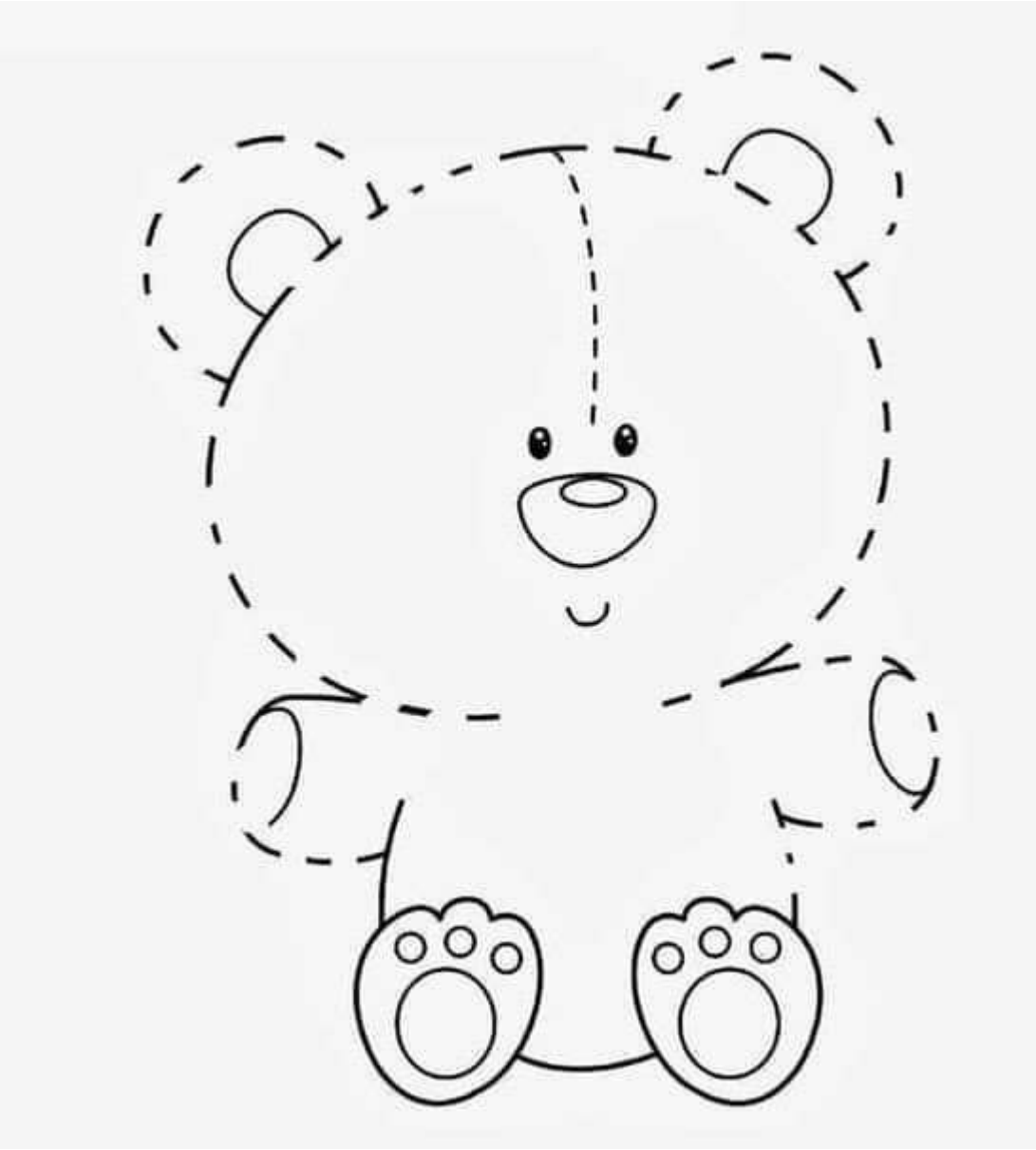



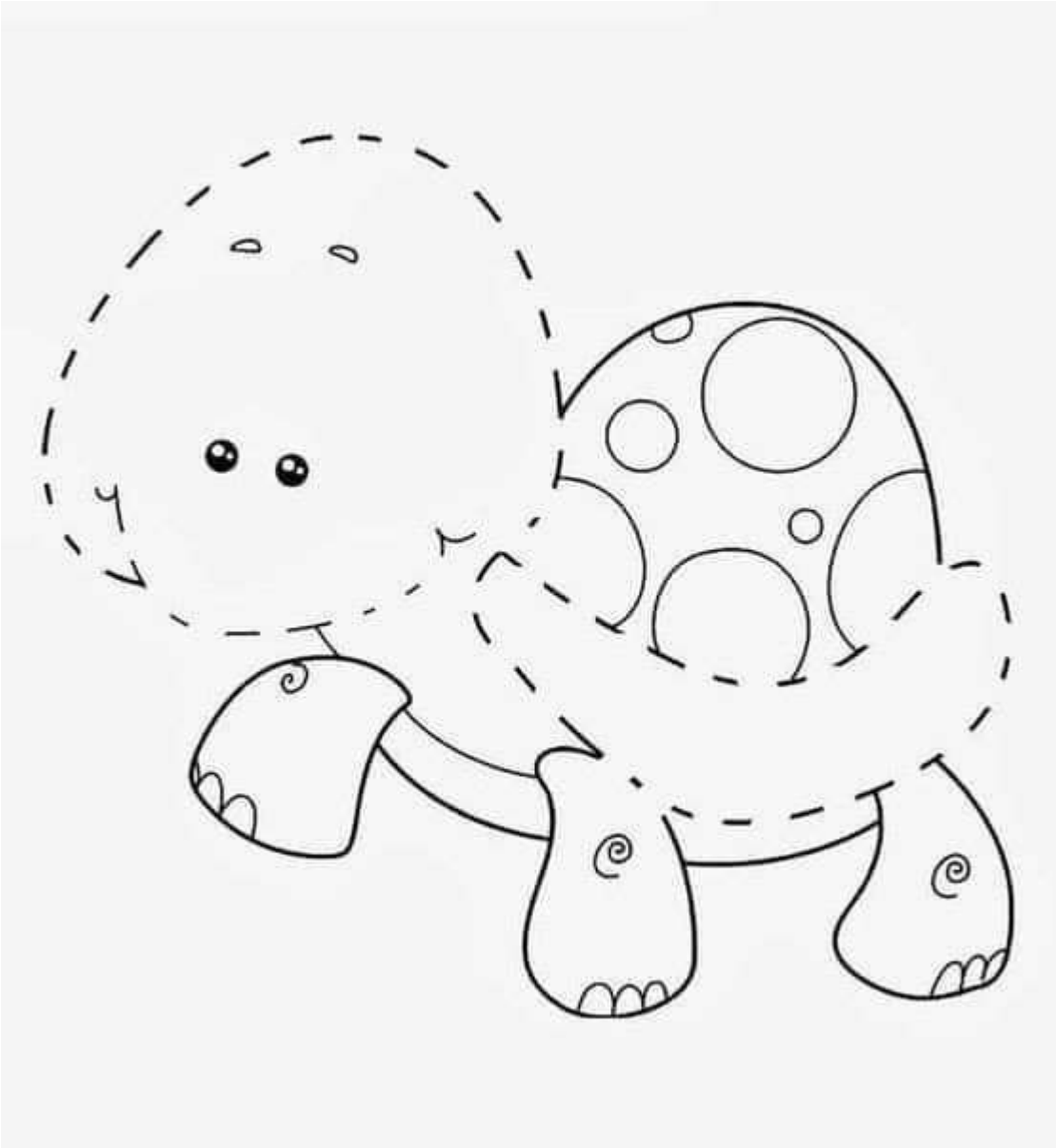

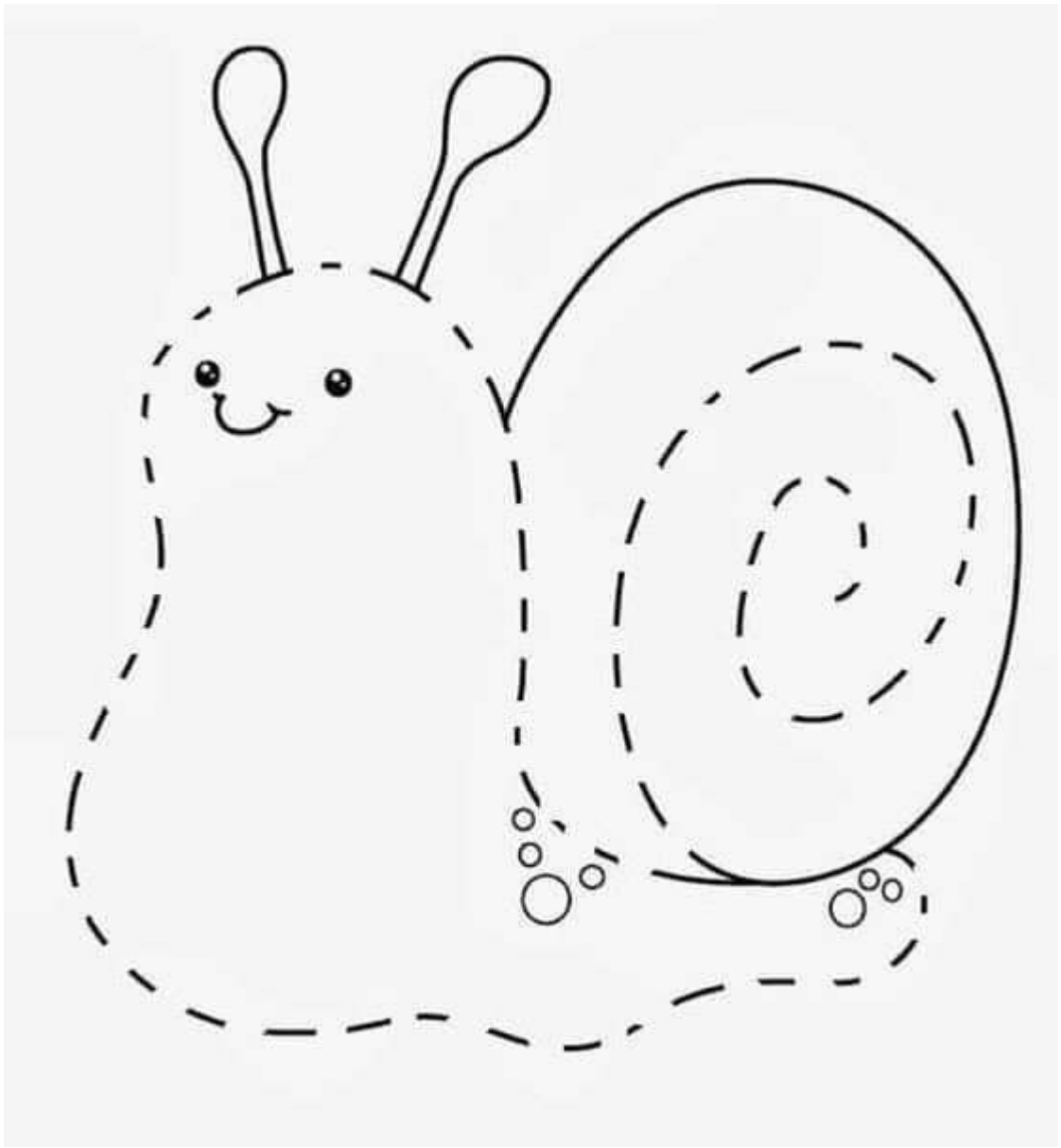

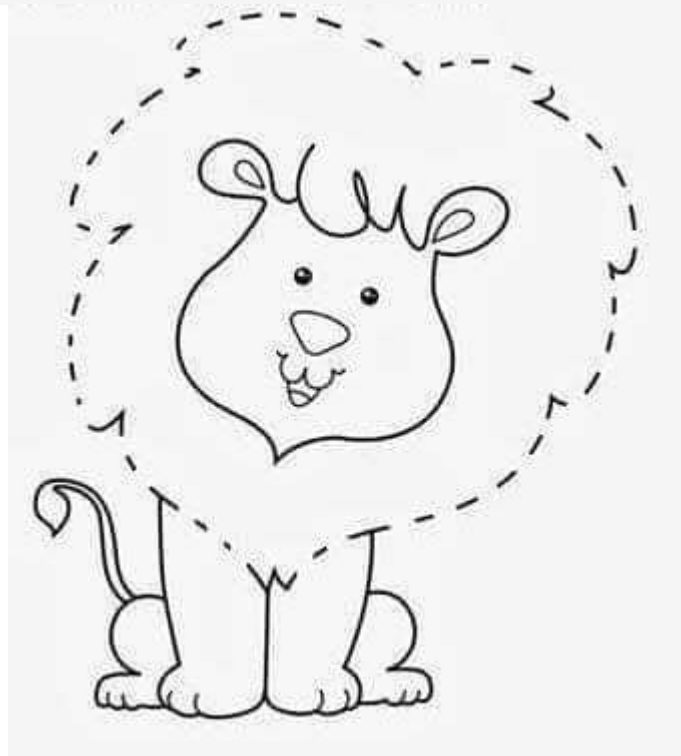
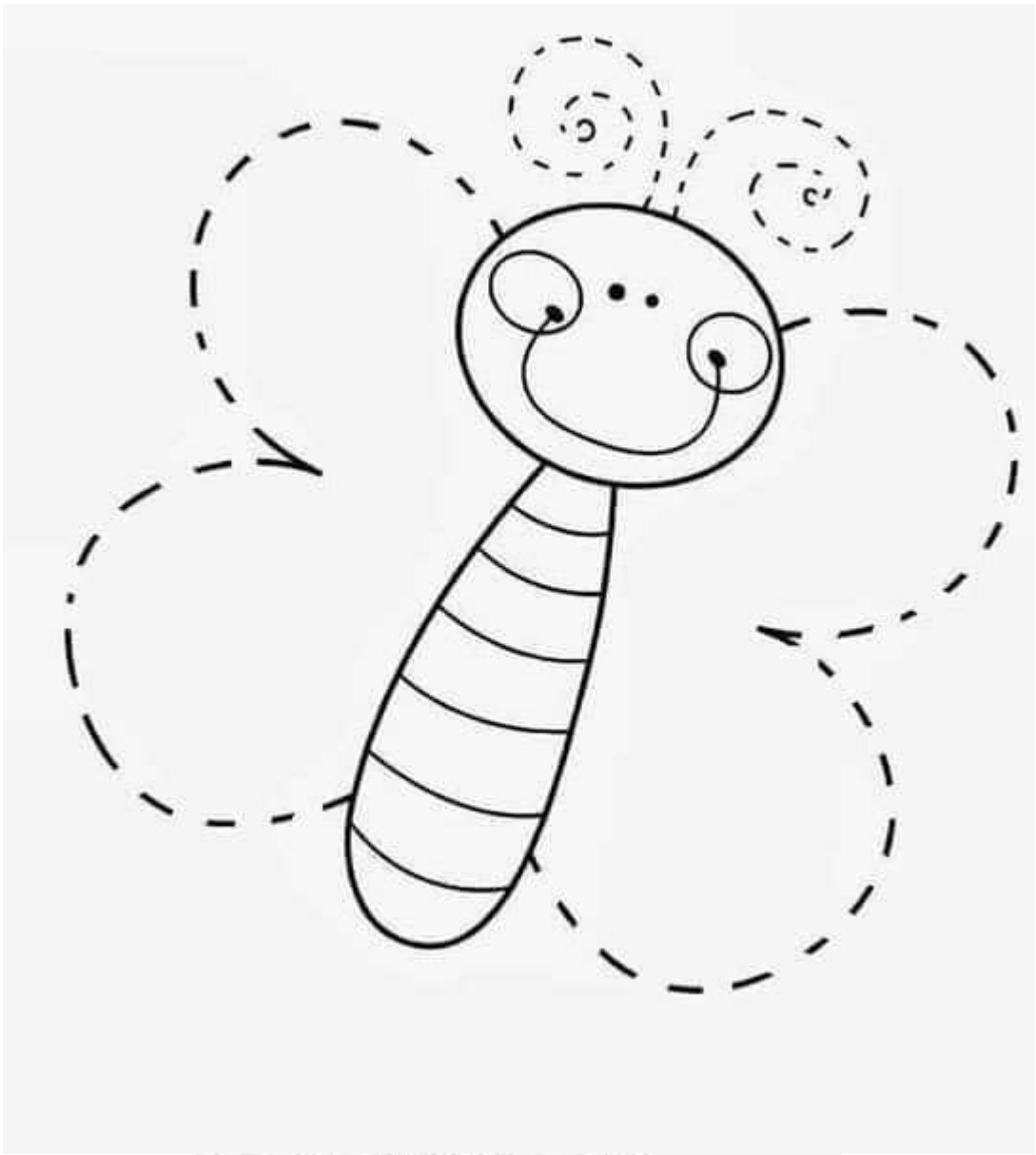

Проведи линии по дорожкам  
не выходя за их края и не  
отрывая карандаш от бумаги.

Дата: \_\_\_\_\_

Имя: \_\_\_\_\_

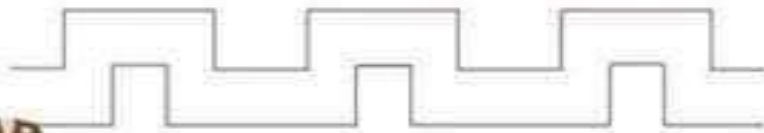
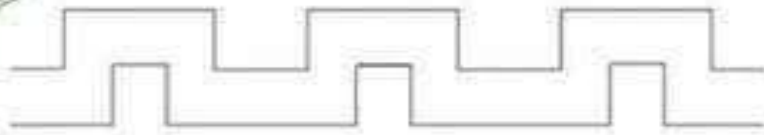
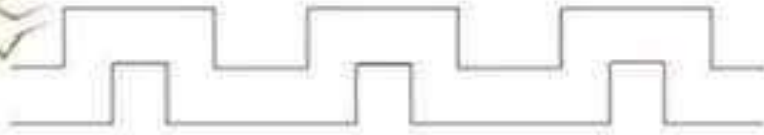

Проведи линии по дорожкам  
не выходя за их края и не  
отрывая карандаш от бумаги.

Дата: \_\_\_\_\_

Имя: \_\_\_\_\_

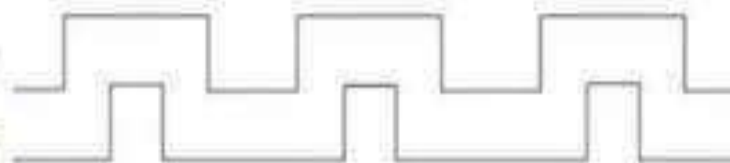
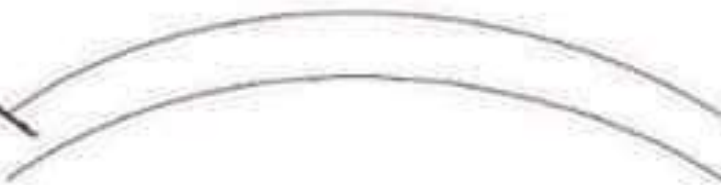
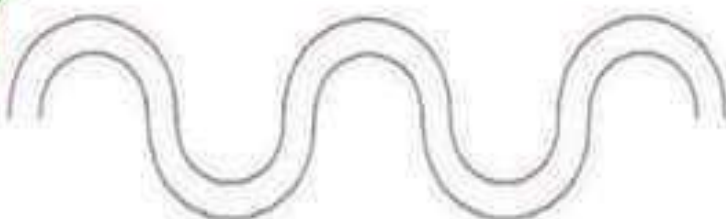

Обведи дорожки  
сплошными линиями

Дата: \_\_\_\_\_

Имя: \_\_\_\_\_

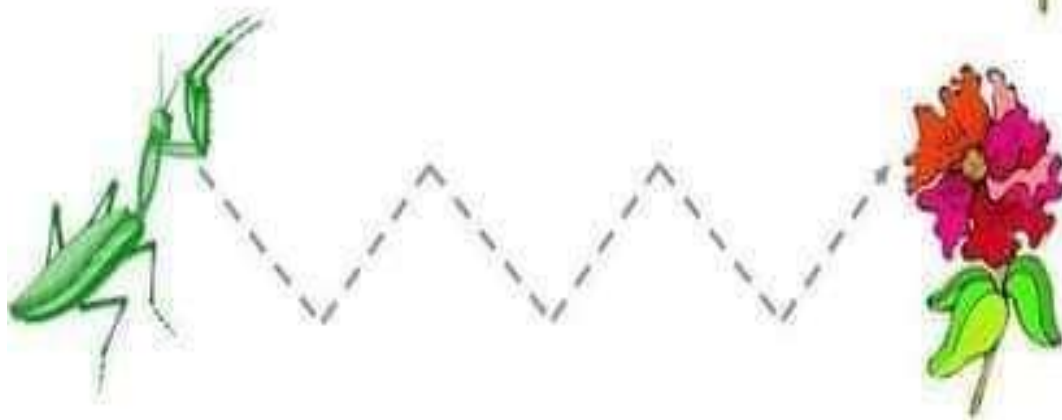
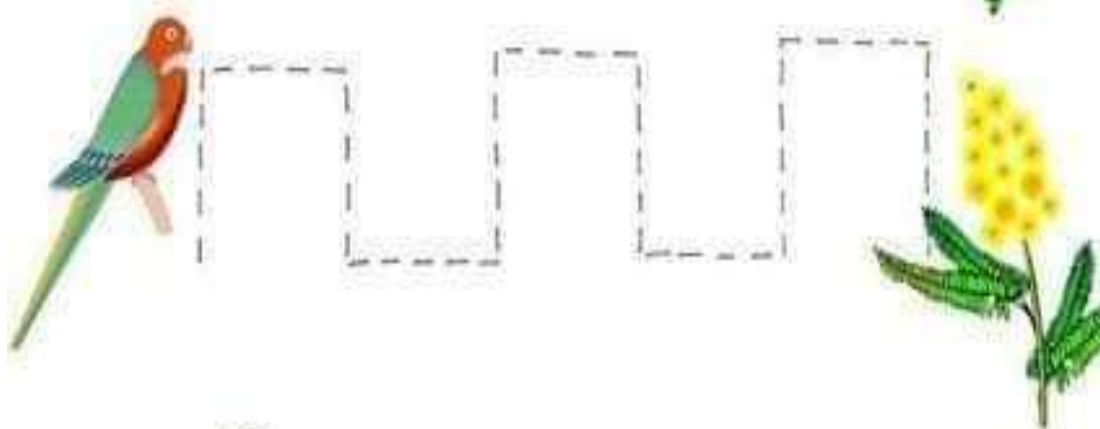
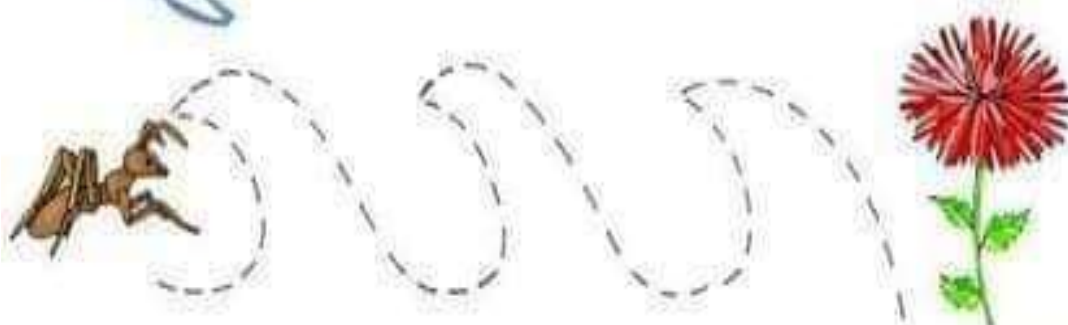



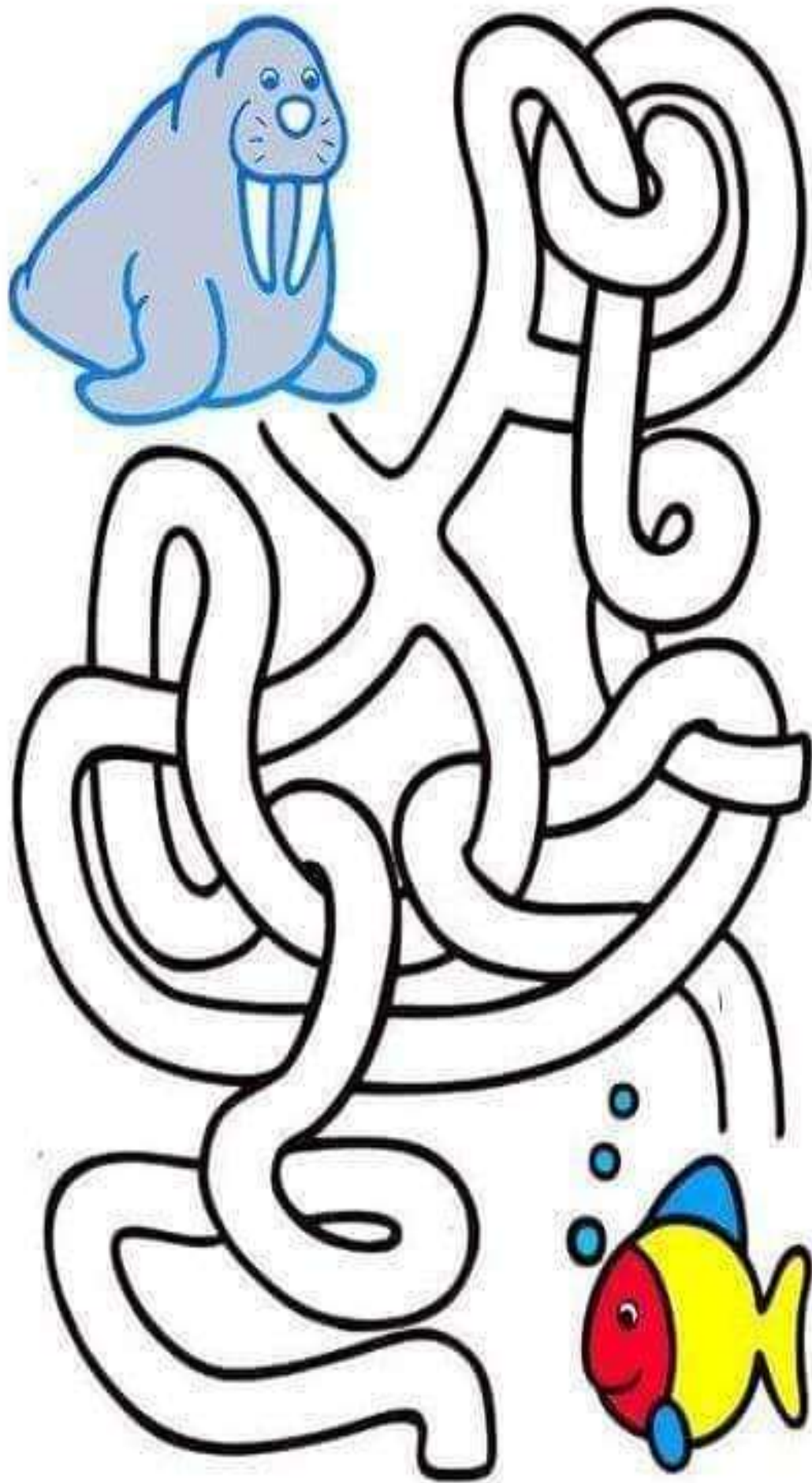



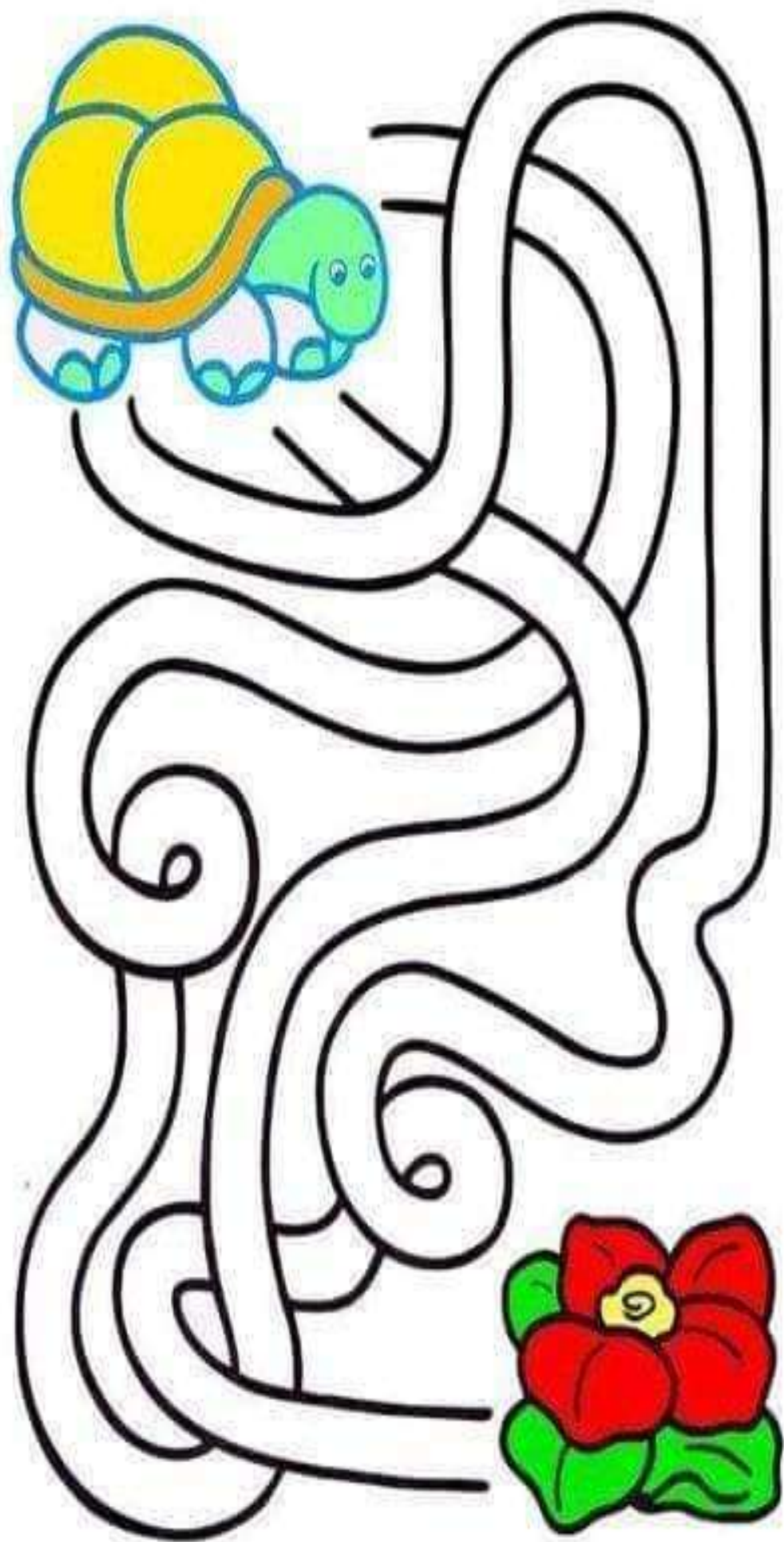

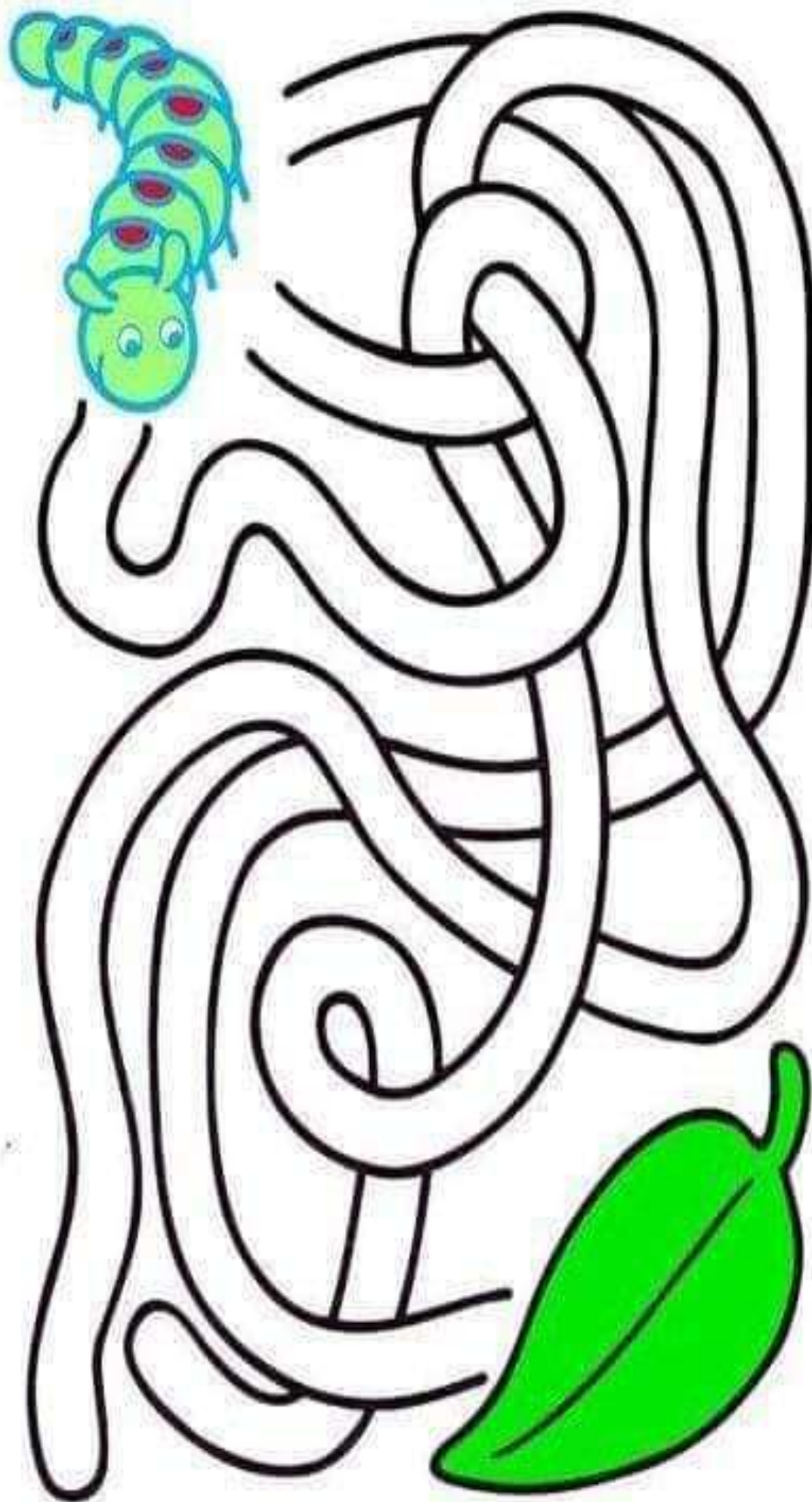

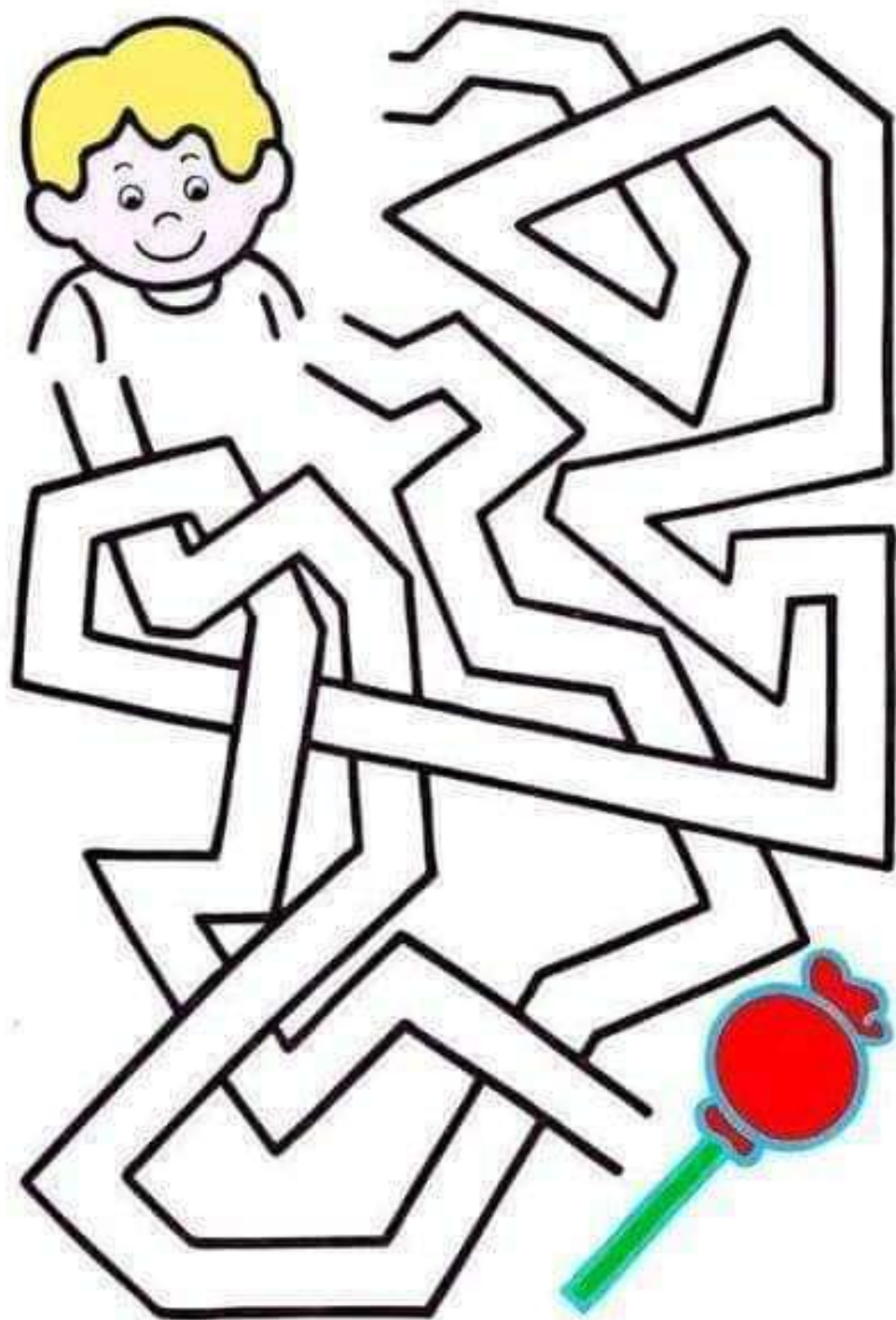

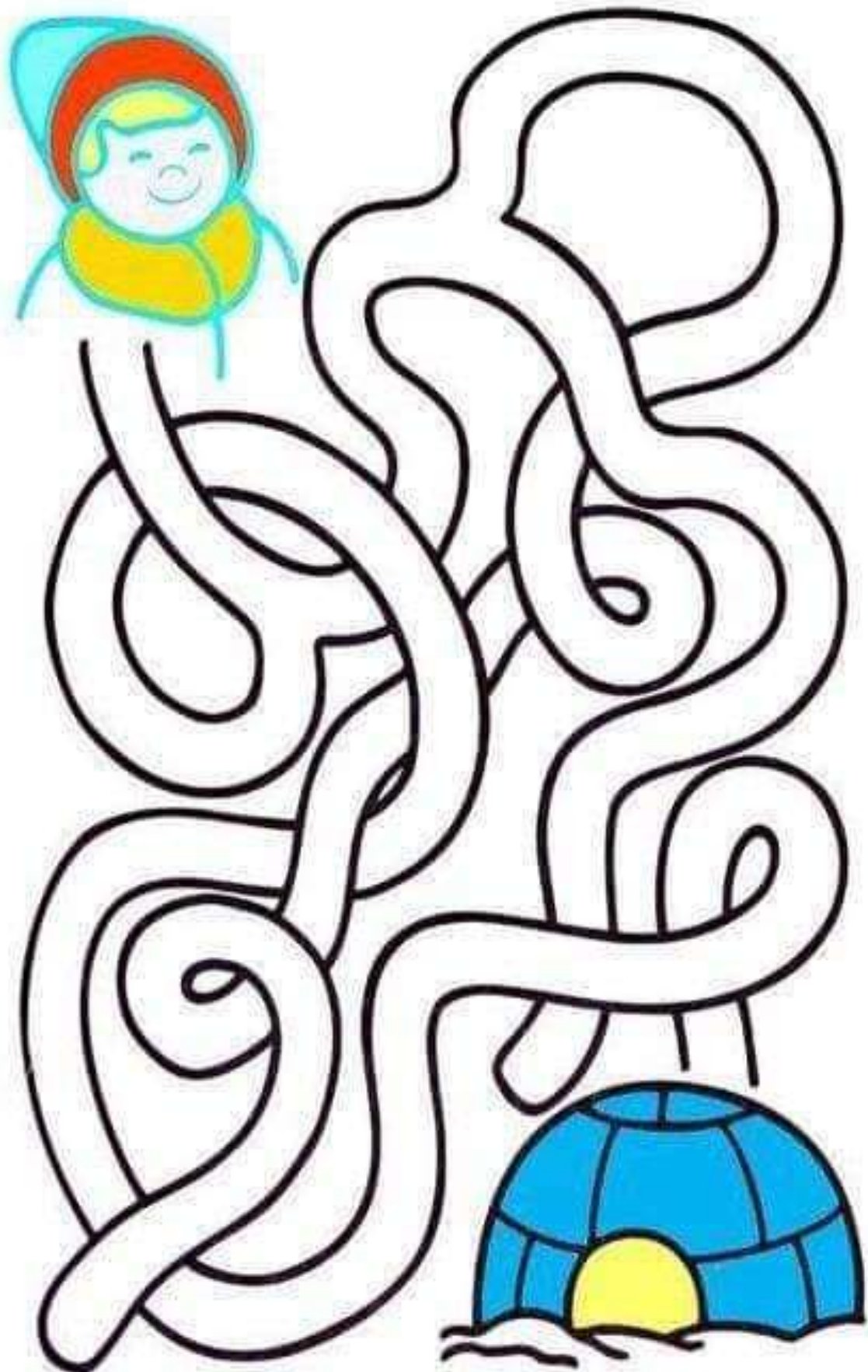

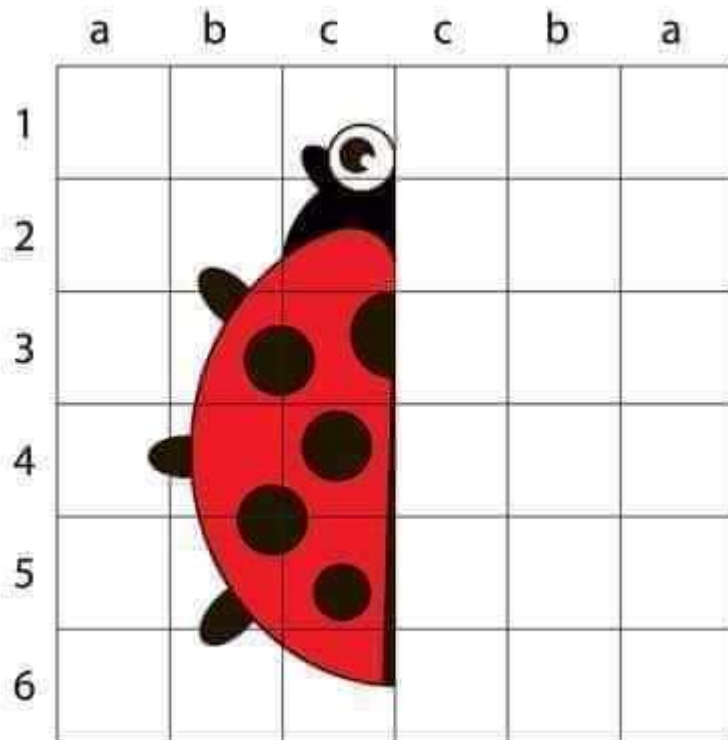
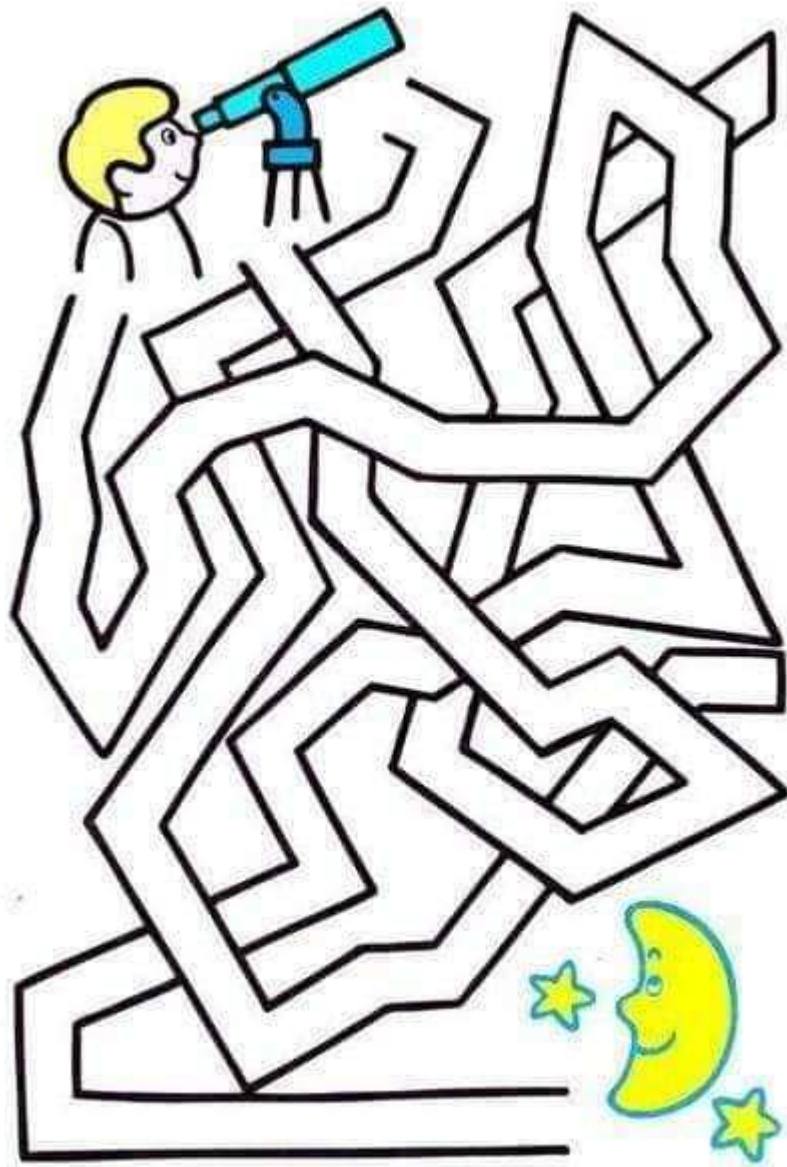

**Copy the picture using the grid.**

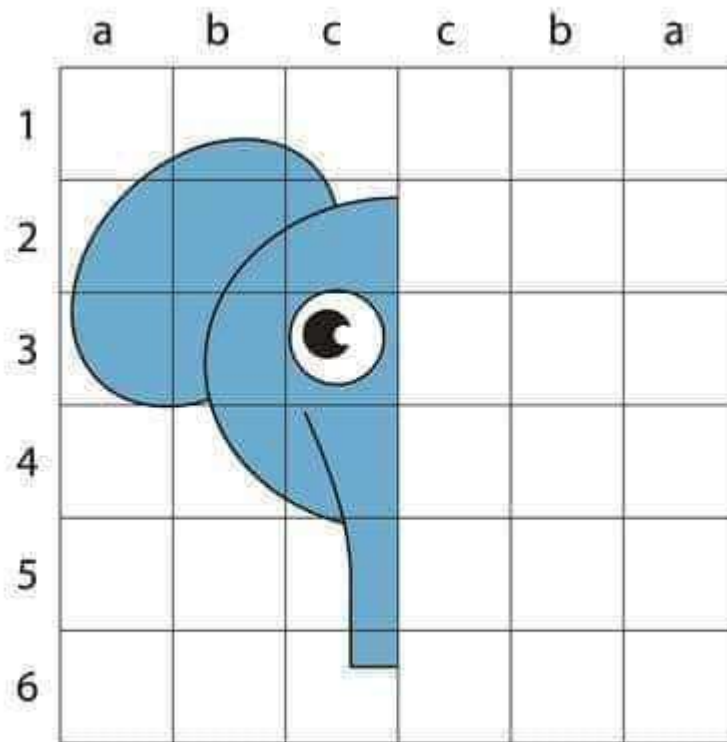

**Copy the picture using the grid.**

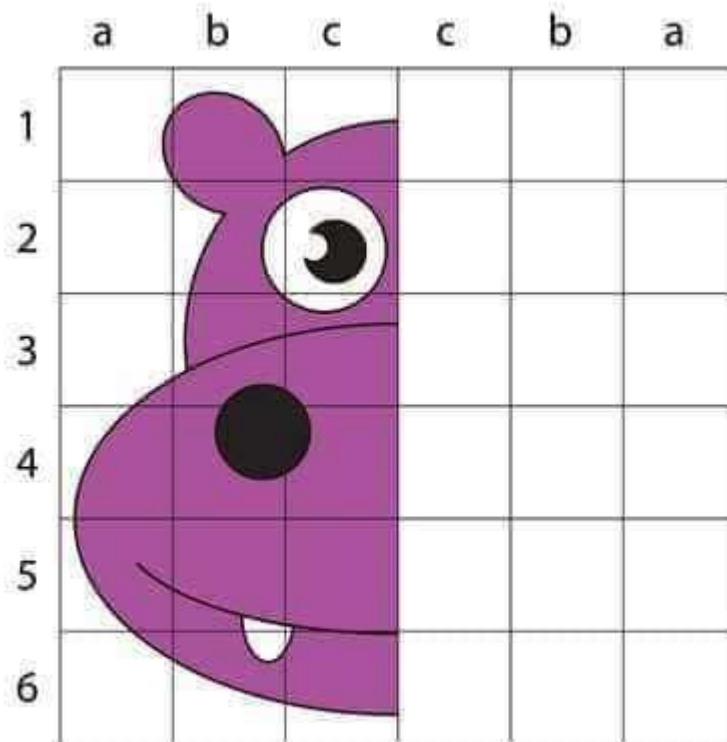

**Copy the picture using the grid.**

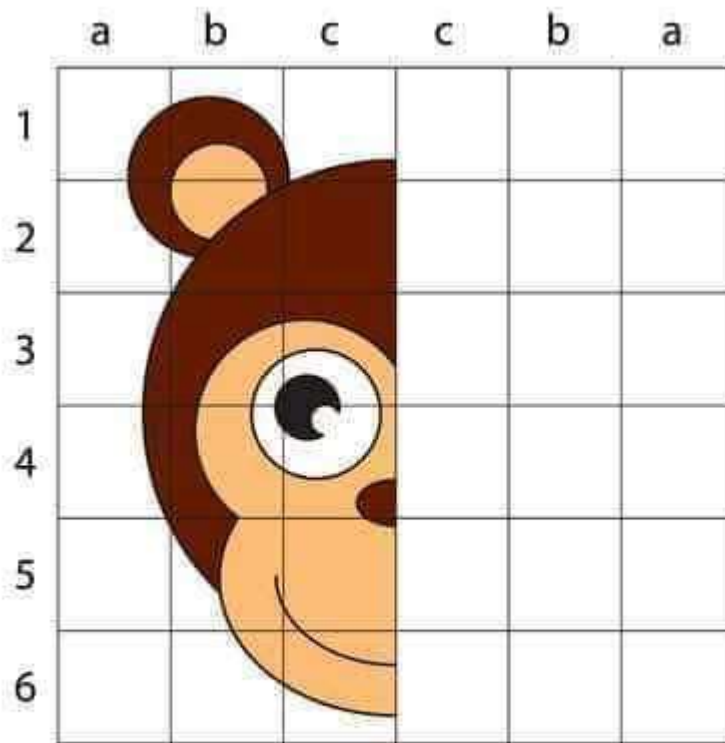

**Copy the picture using the grid.**

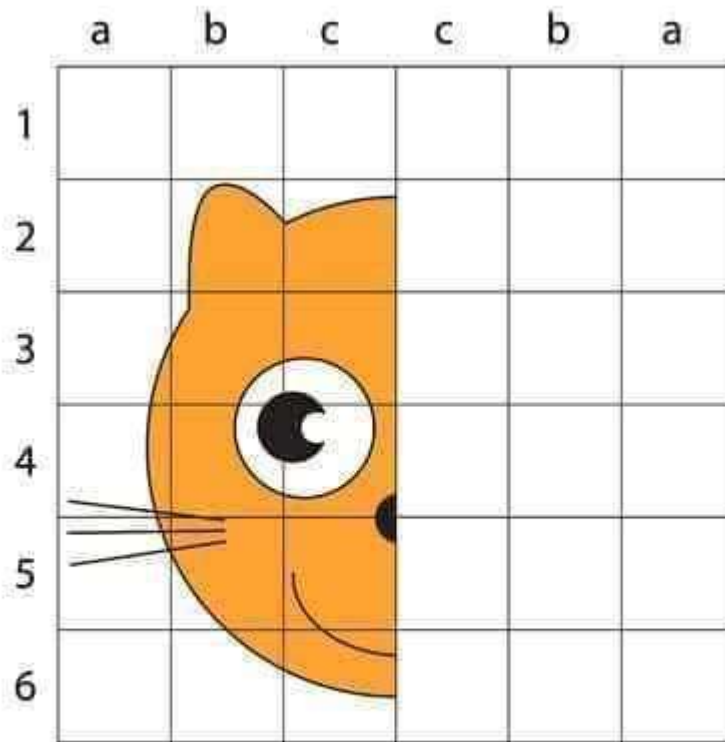

**Copy the picture using the grid.**

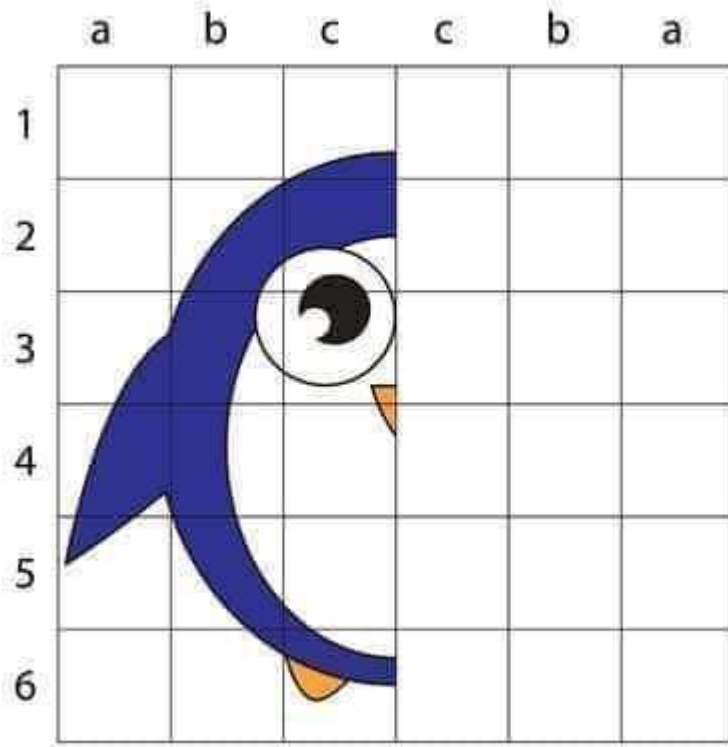

**Copy the picture using the grid.**

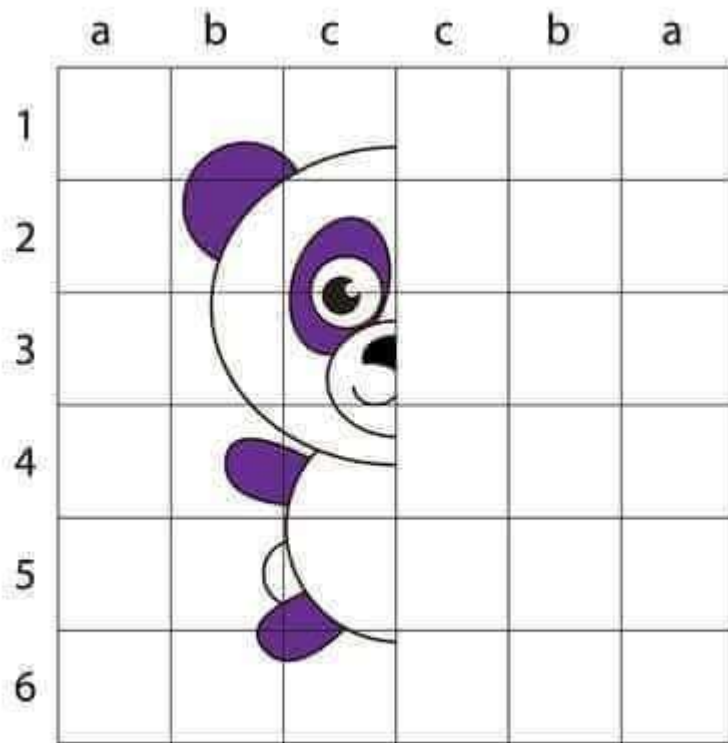

**Copy the picture using the grid.**



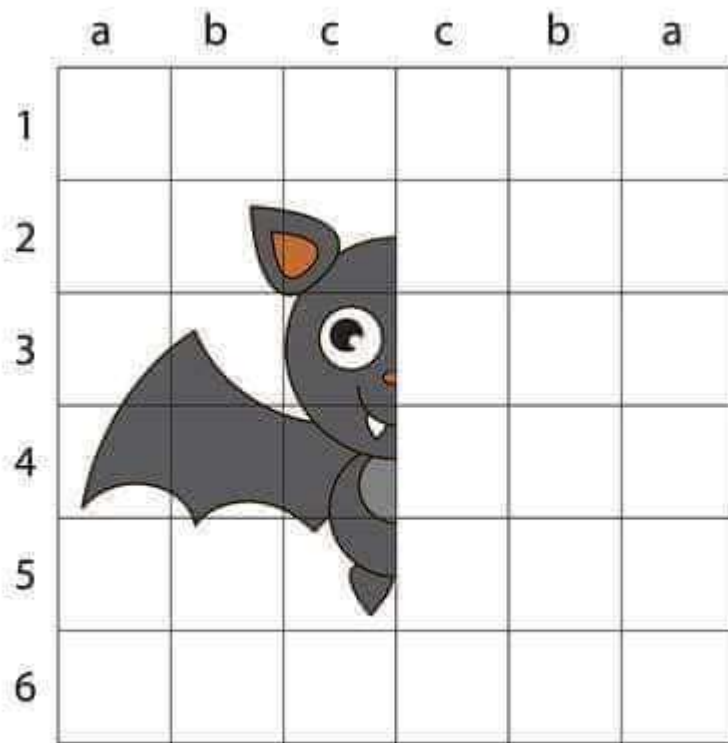

**Copy the picture using the grid.**

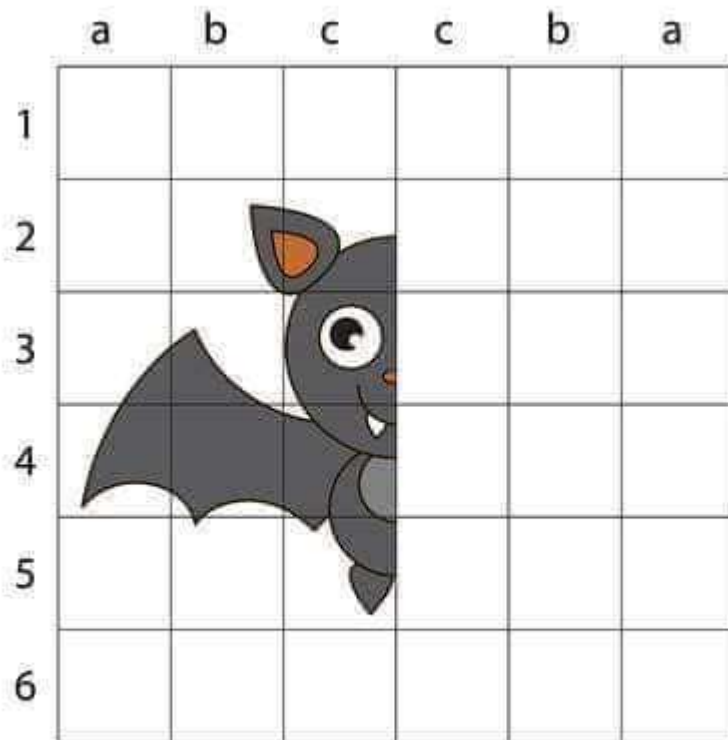

**Copy the picture using the grid.**

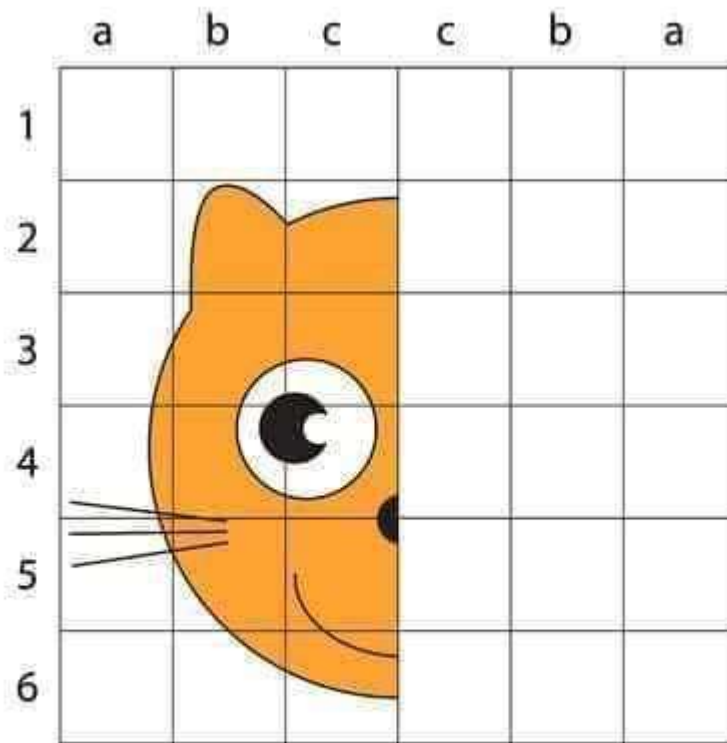

**Copy the picture using the grid.**

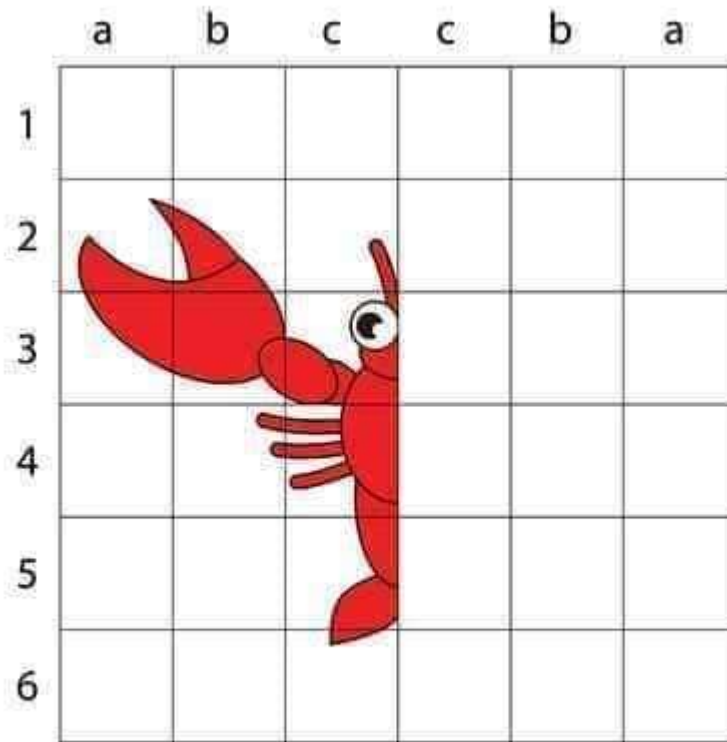

**Copy the picture using the grid.**

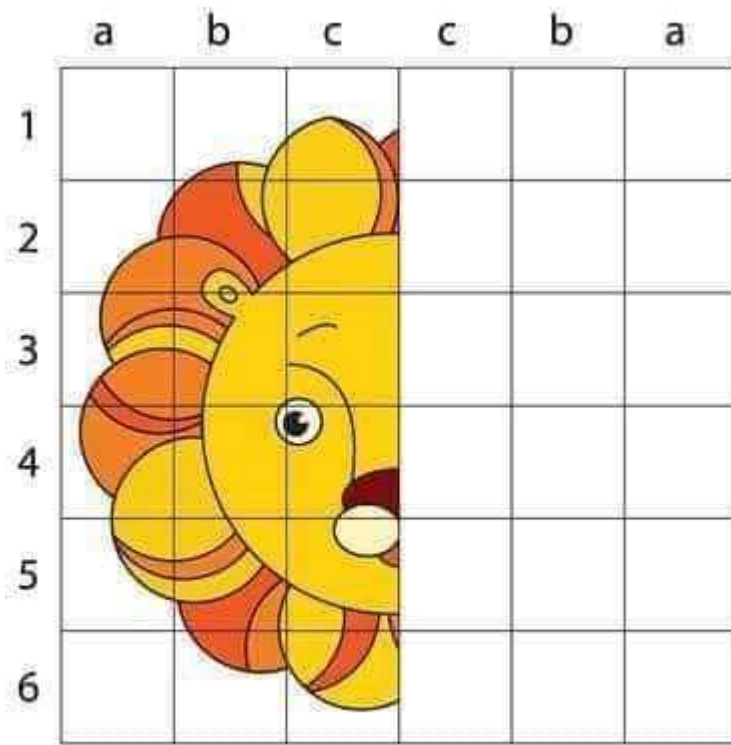

**Copy the picture using the grid.**

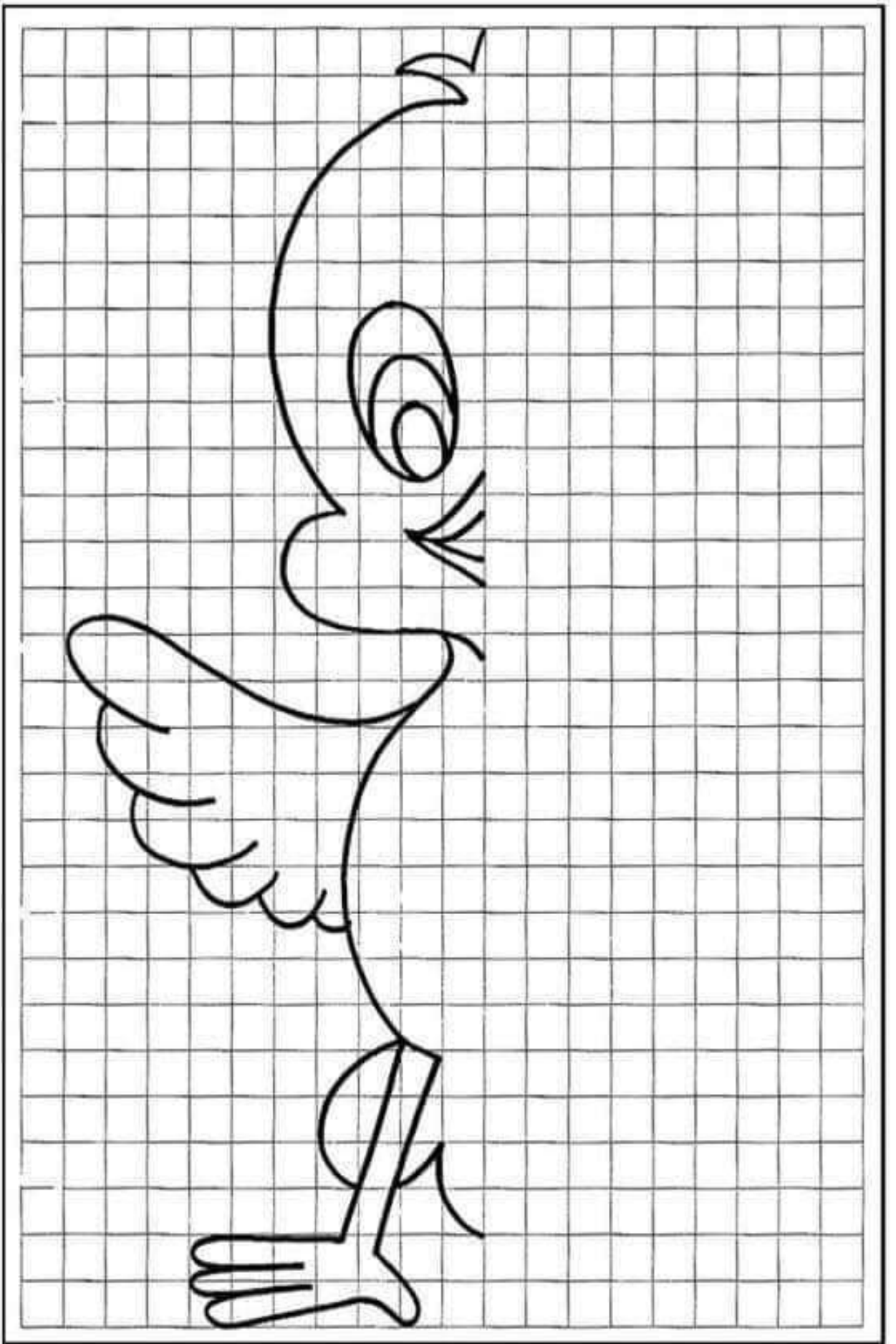

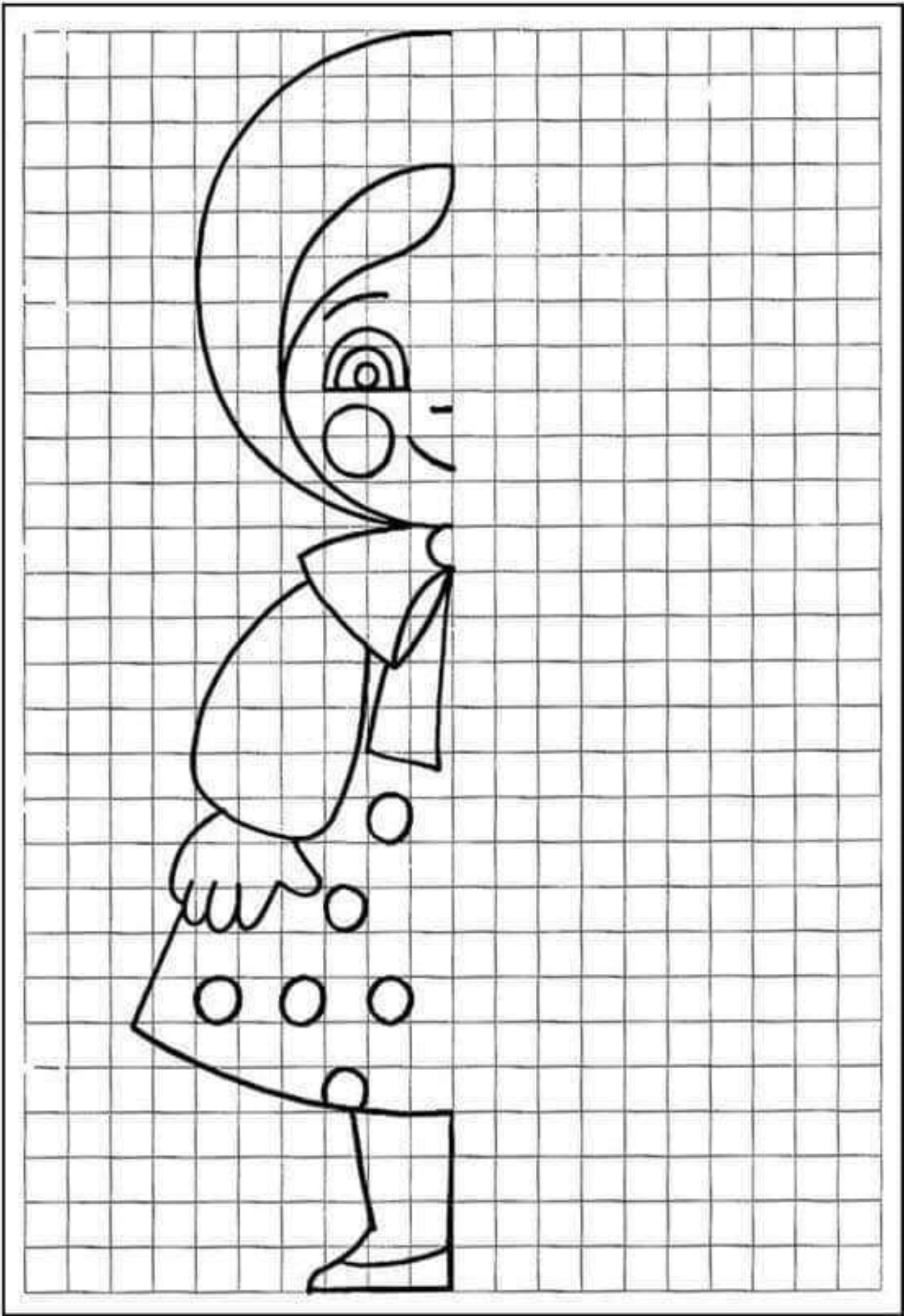

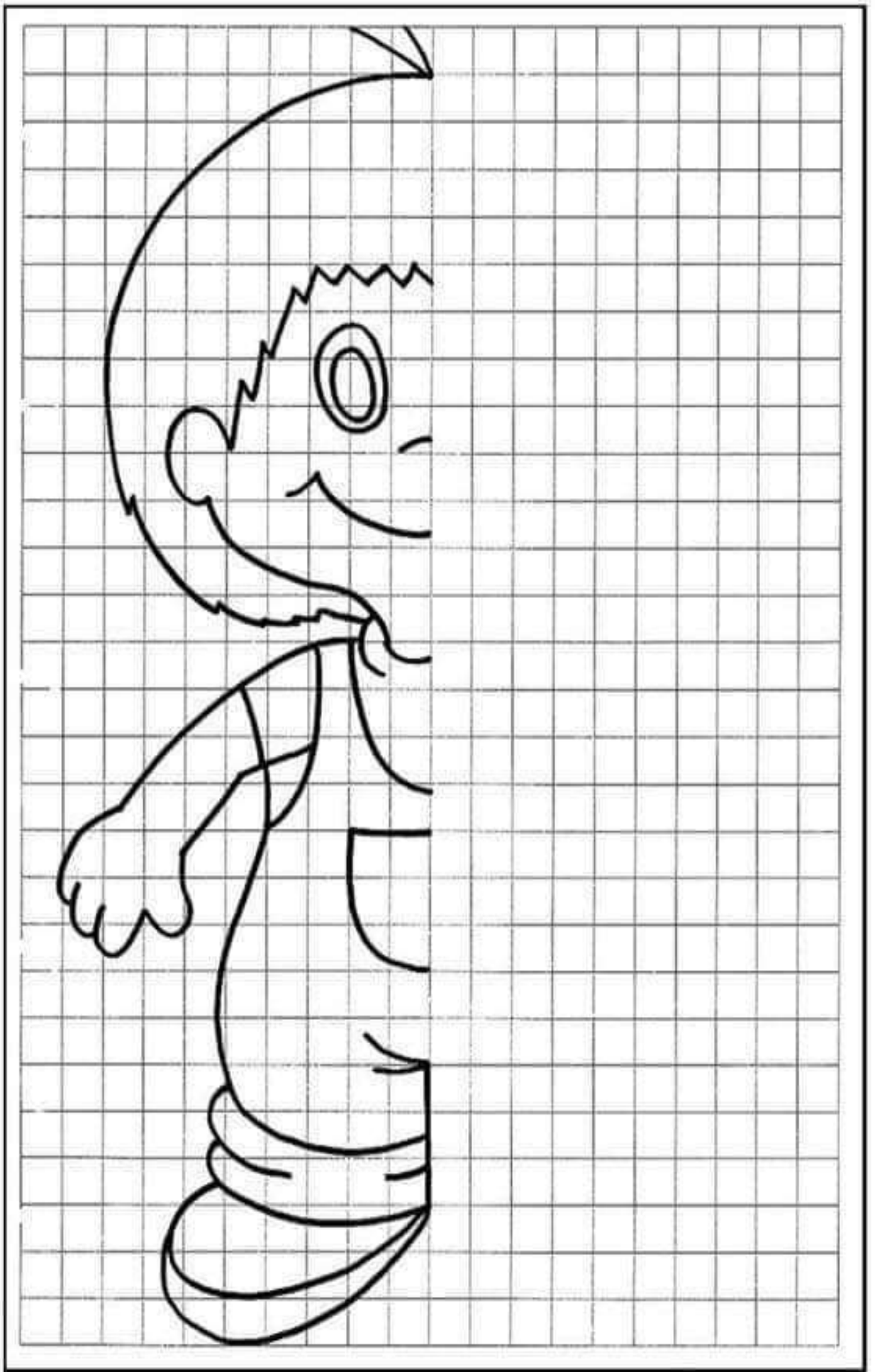

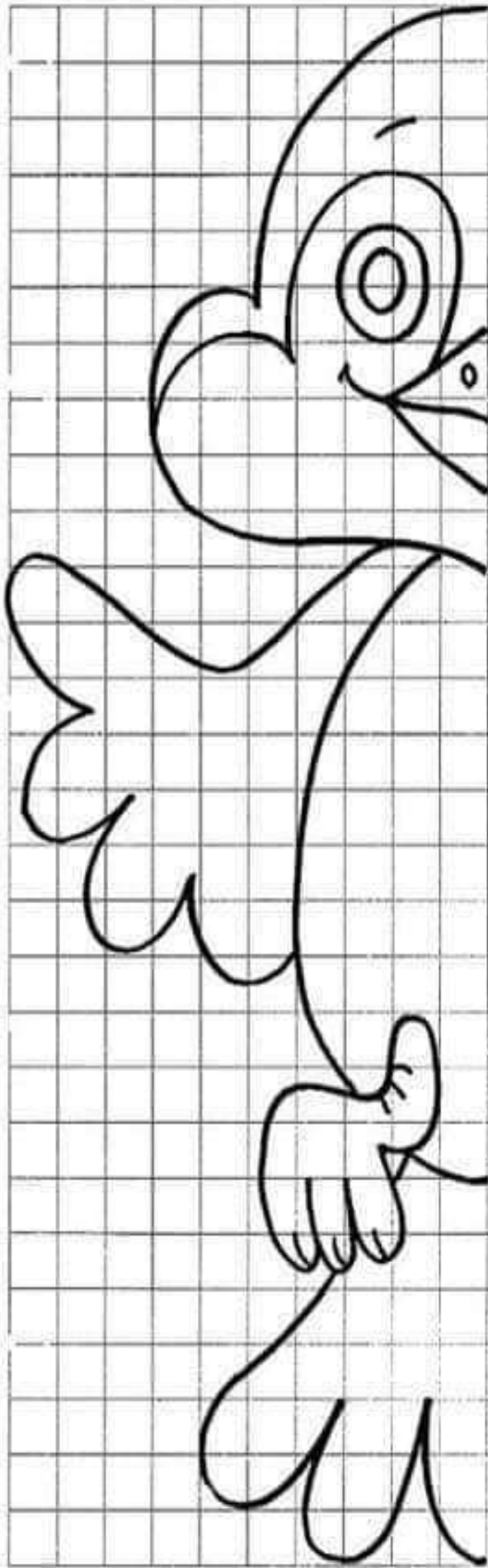

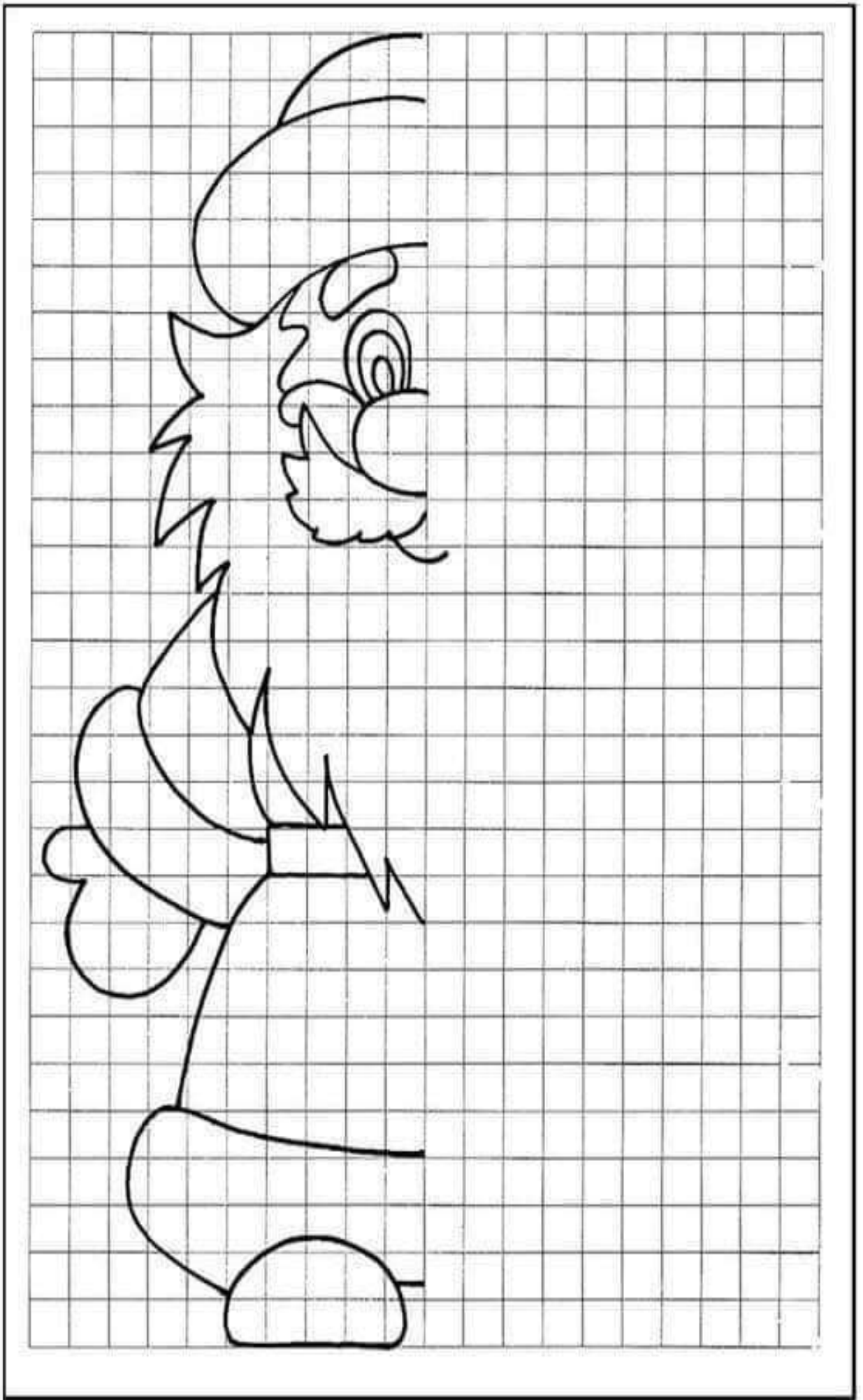



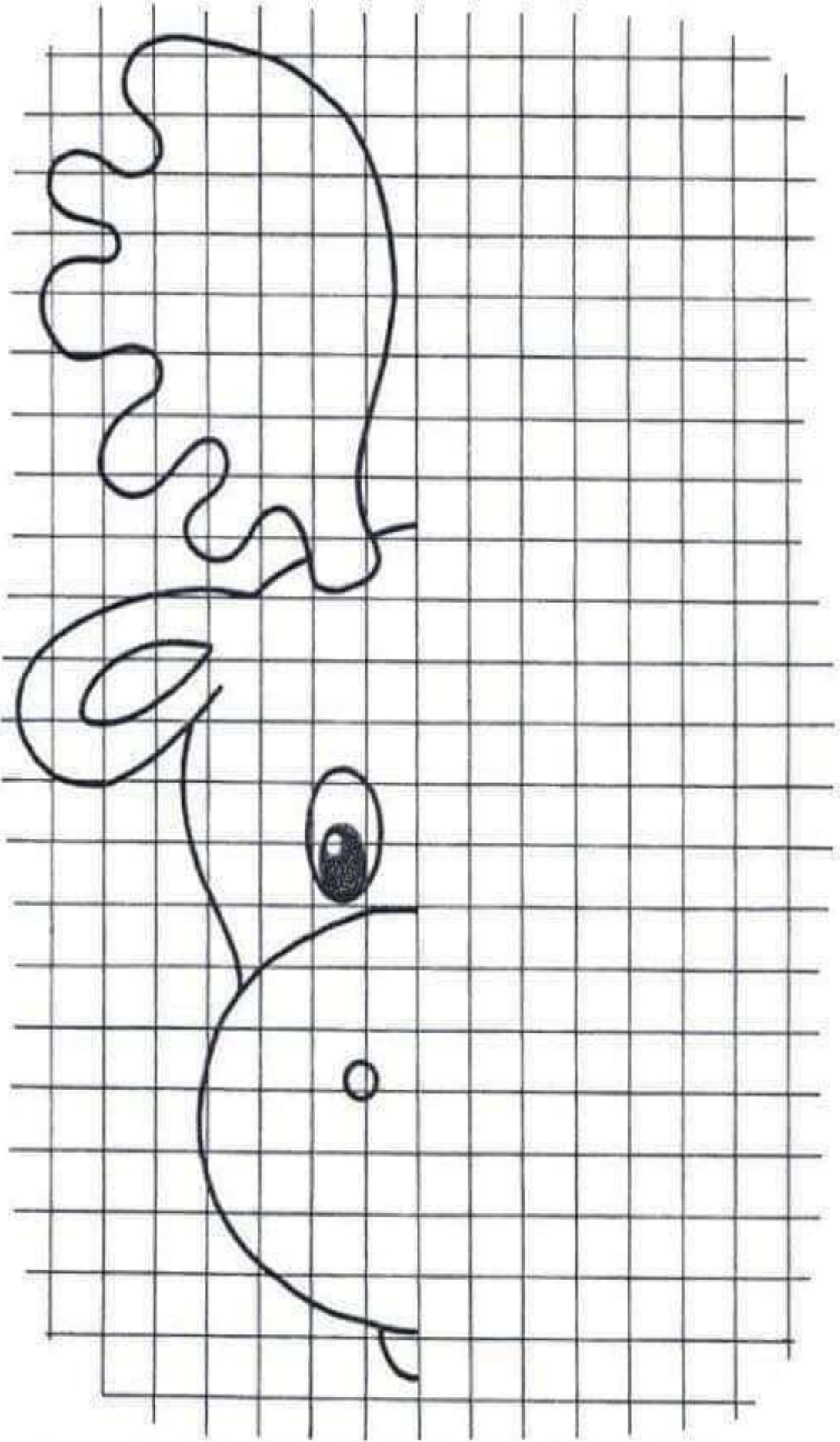

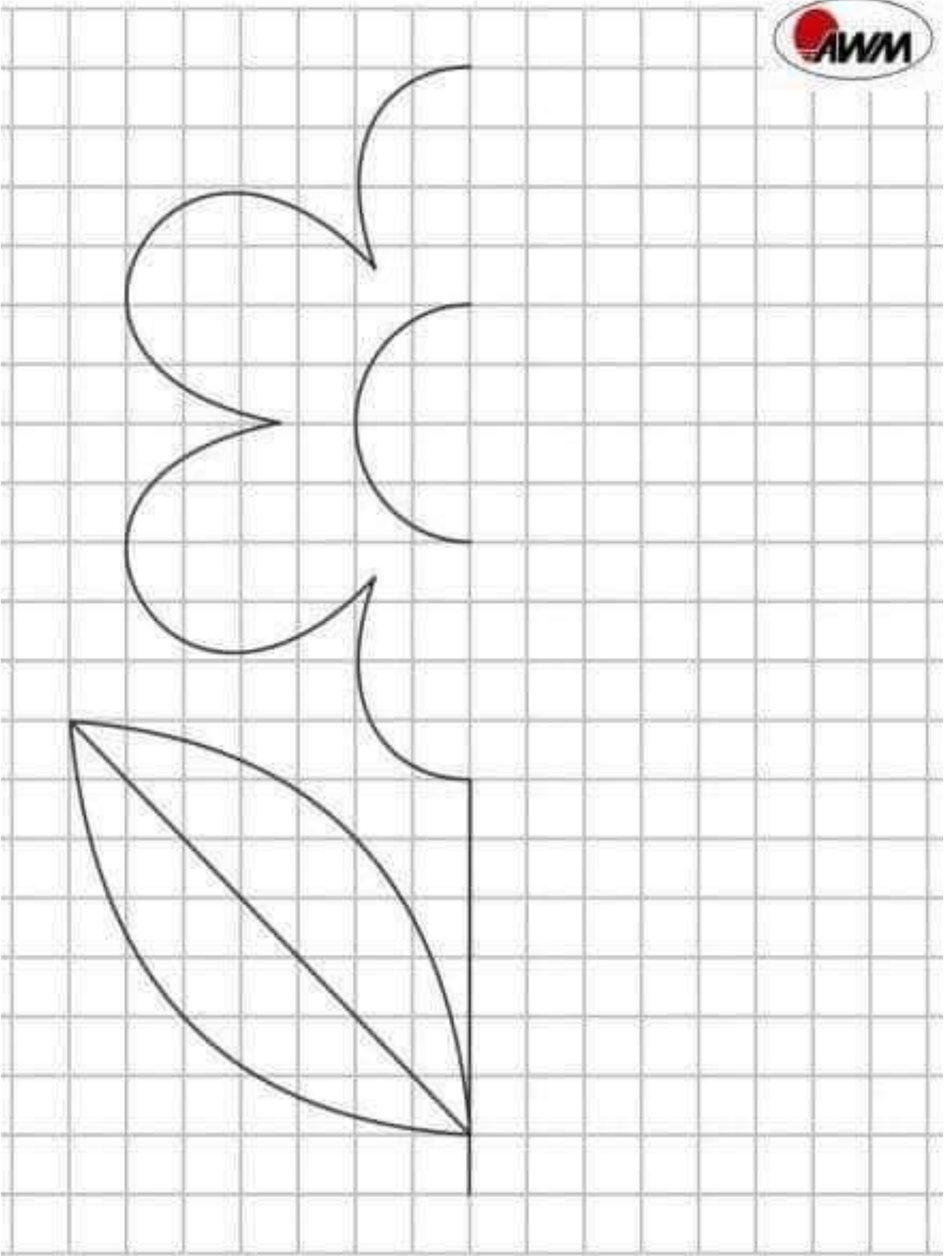

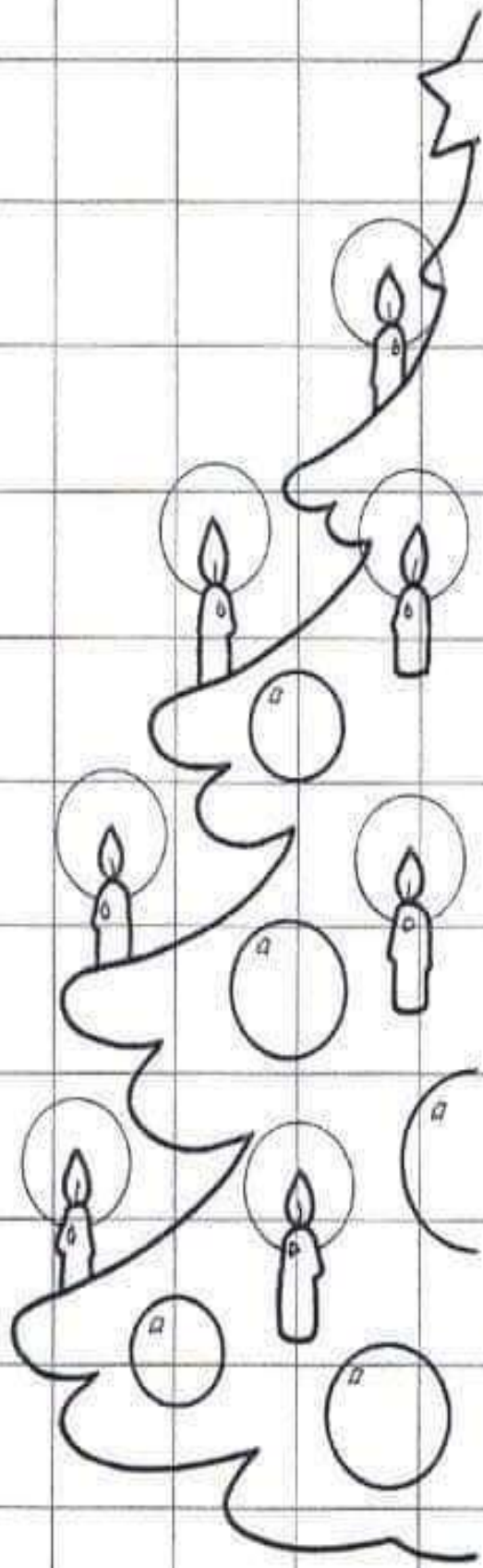

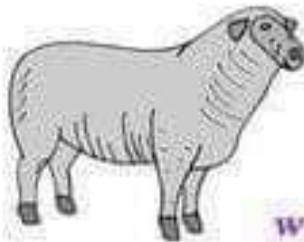
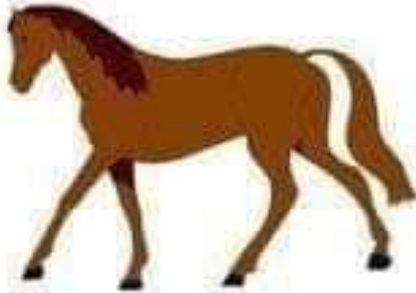
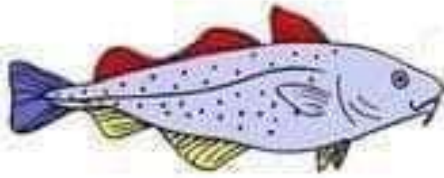
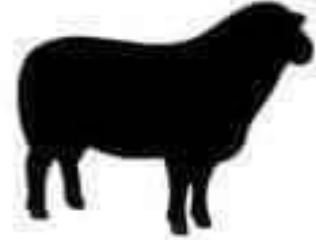
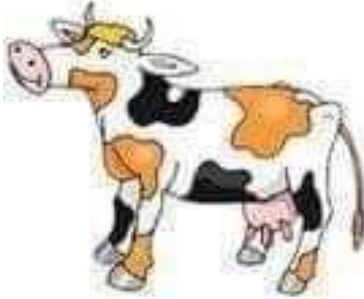
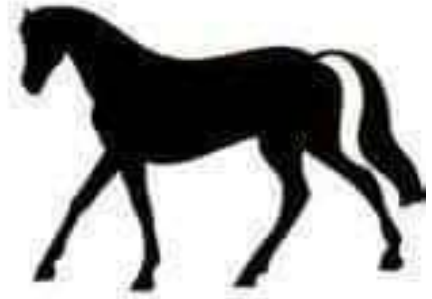

[www.justformoms.com.ua](http://www.justformoms.com.ua)

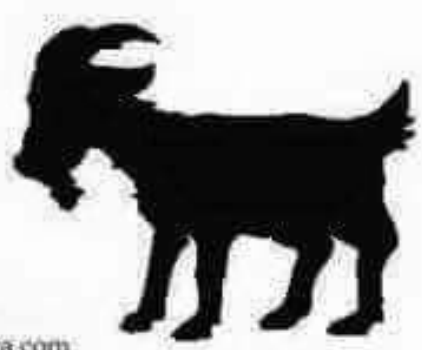
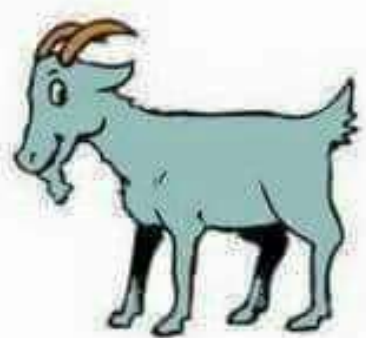



Relie chaque animal à son ombre.

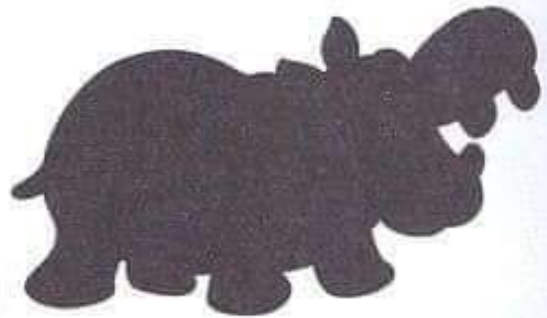
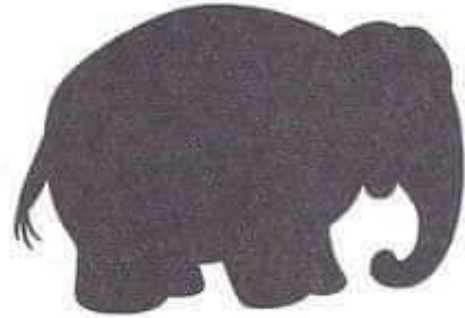
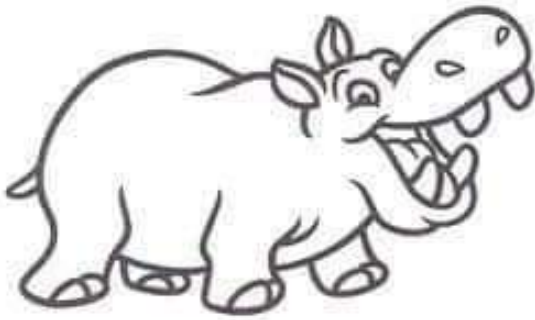
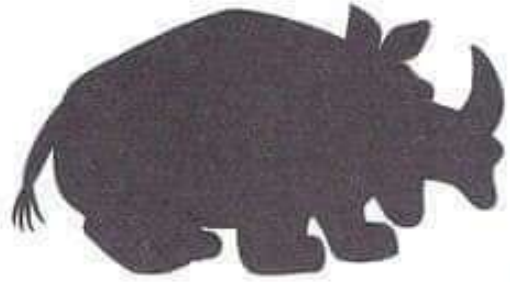
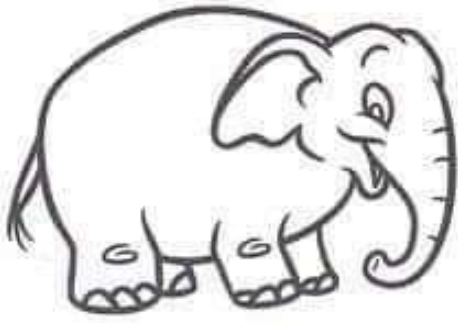

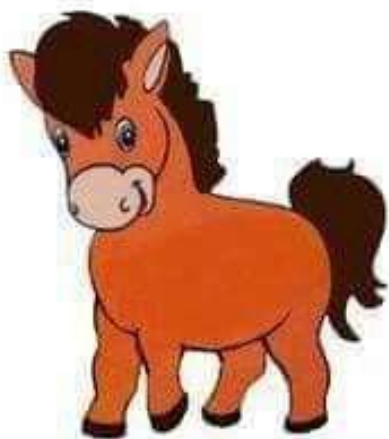
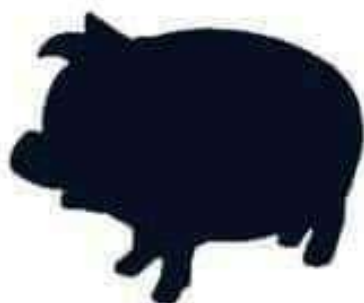

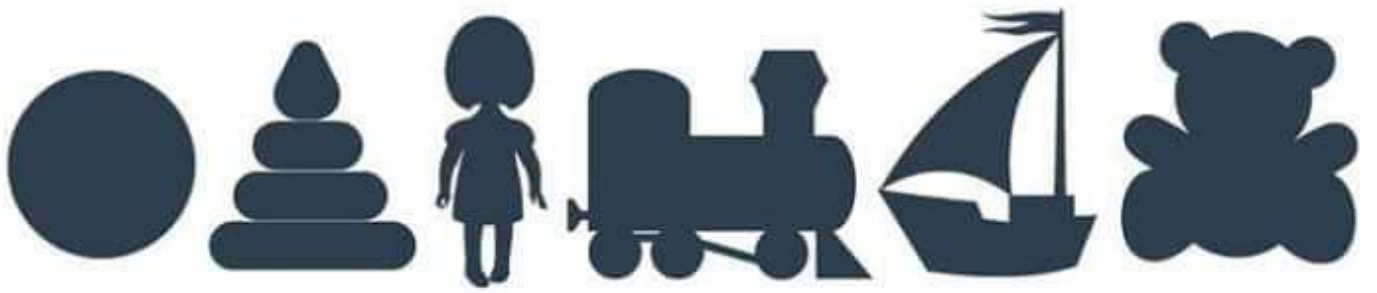



# КОЯ Е ВЯРНАТА СЯНКА?



Изработил: Силвия Анова















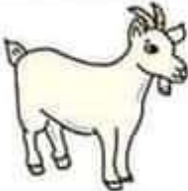







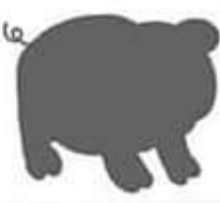







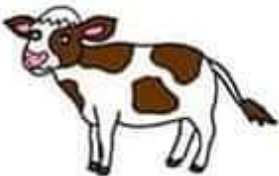

# КОЯ Е ВЯРНАТА СЯНКА?



Изработил: Силвия Анова



Který stín patří k barevnému zvířátku?

				
				
				
				
				
				
				

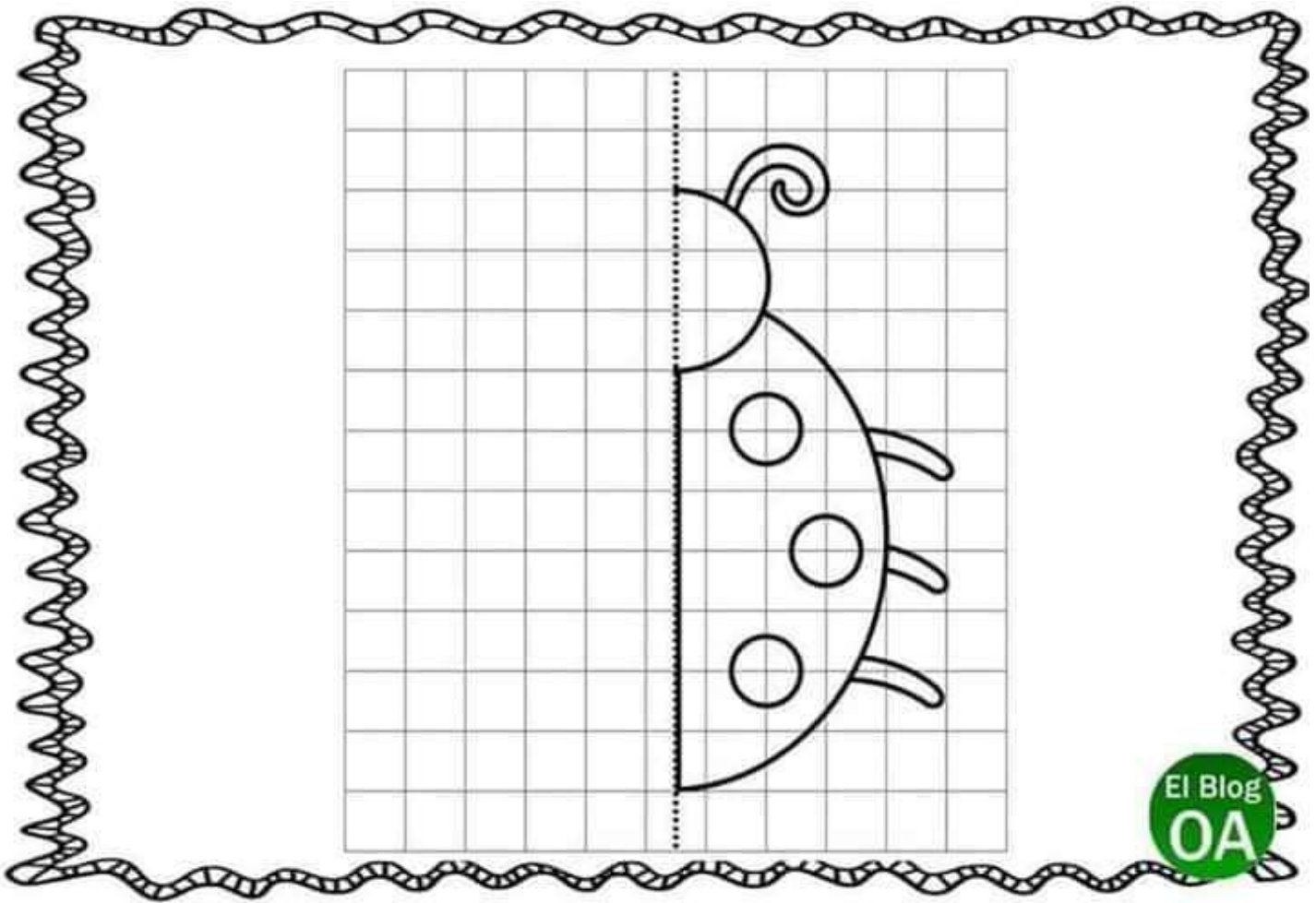

El Blog  
OA

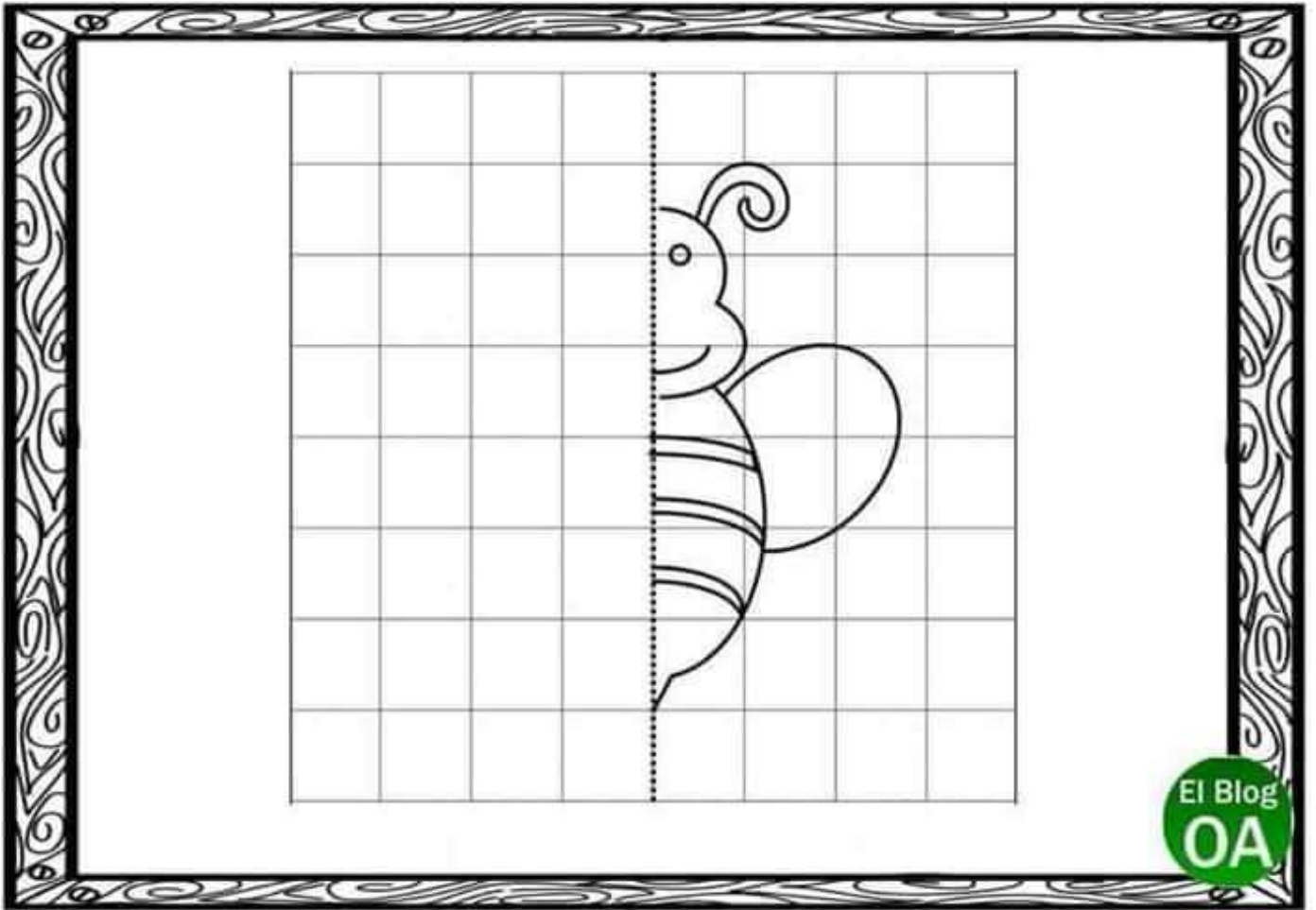

El Blog  
OA

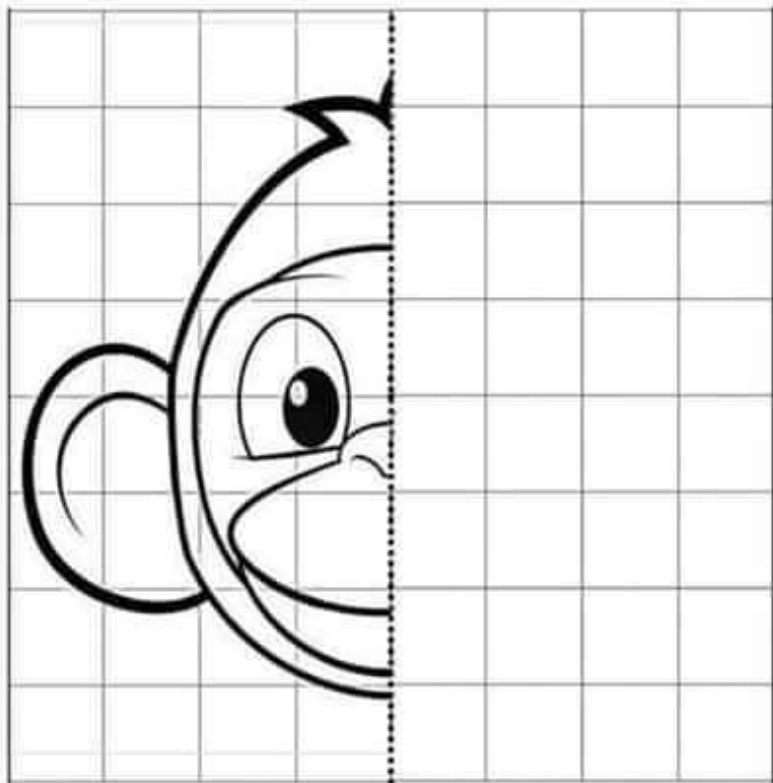

El Blog  
OA

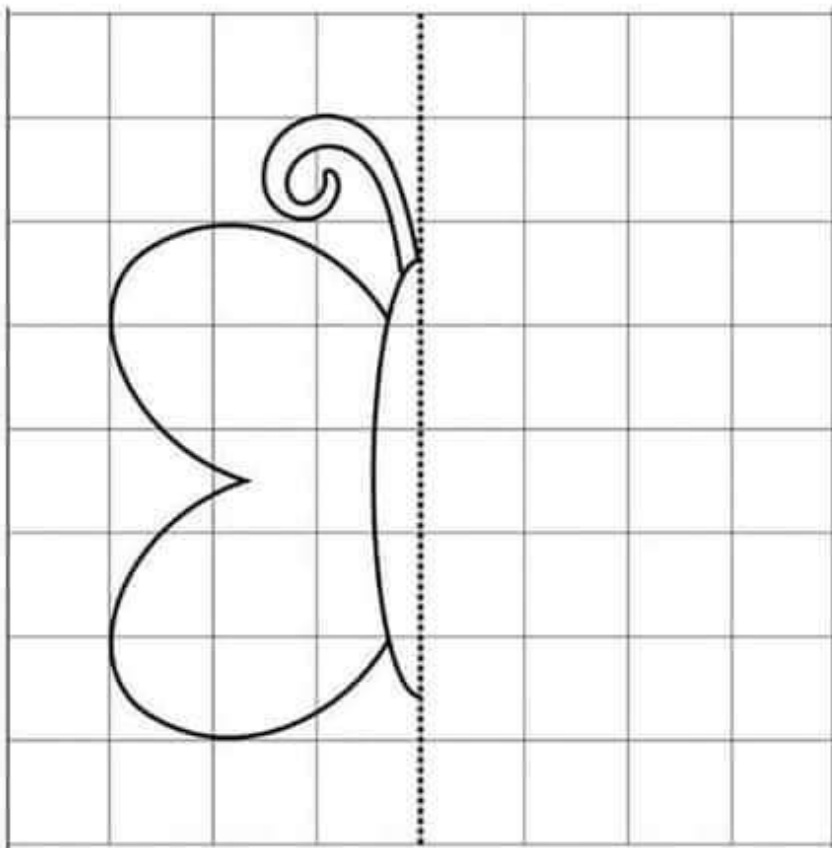

El Blog  
OA

Cut along the lines

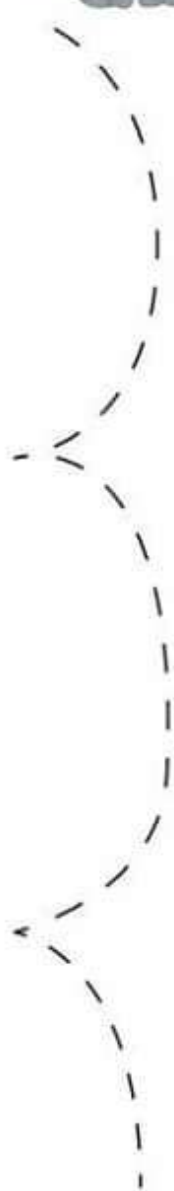

Trace along the lines

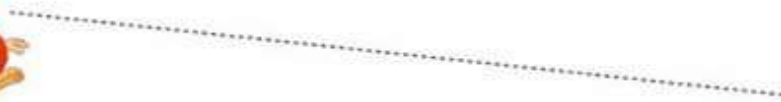
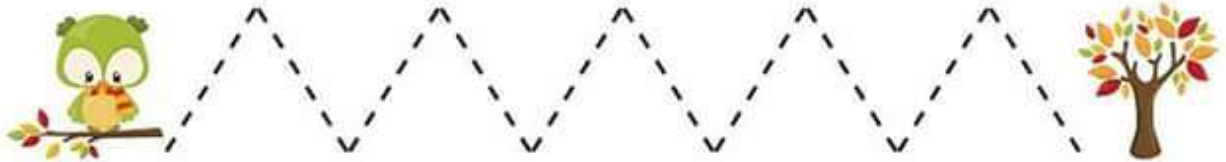
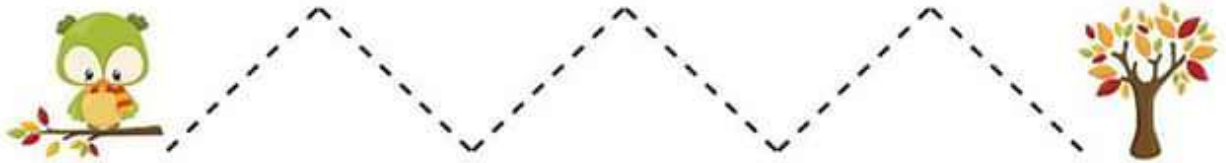

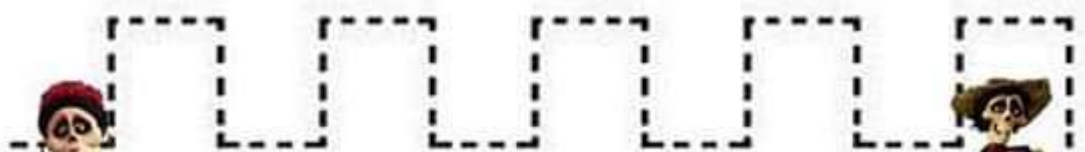
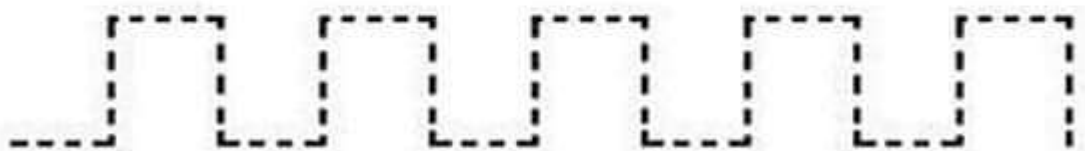
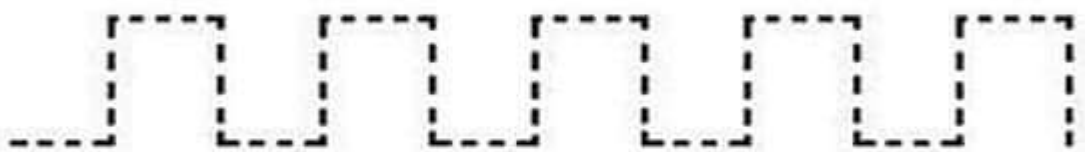
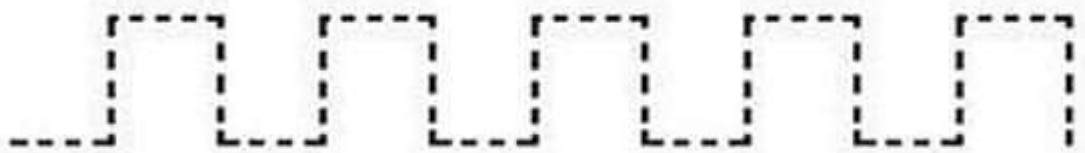
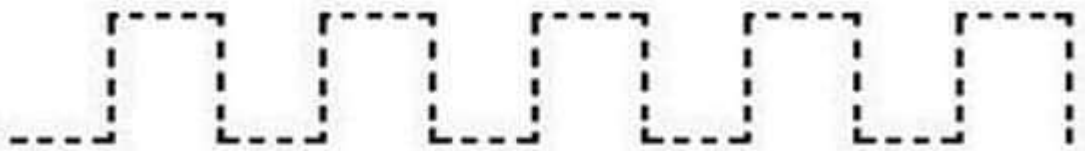
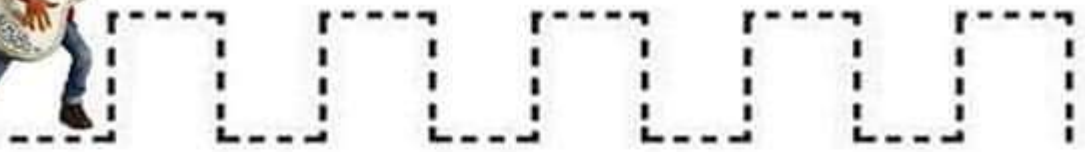

COCO





# TOY STORY

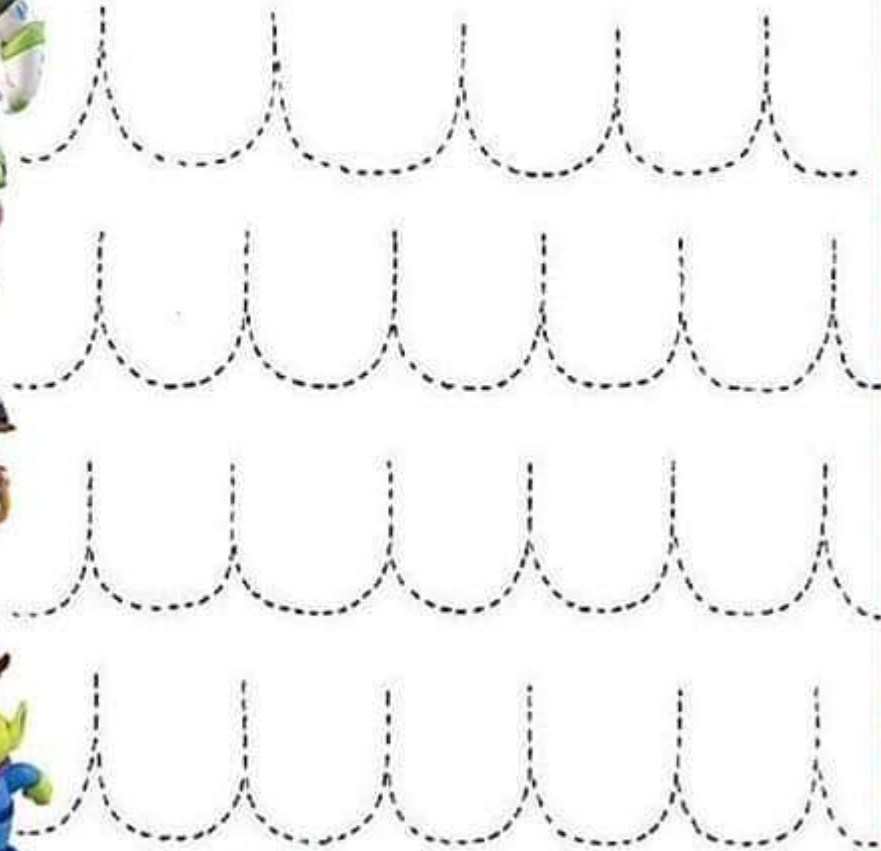



# COCO

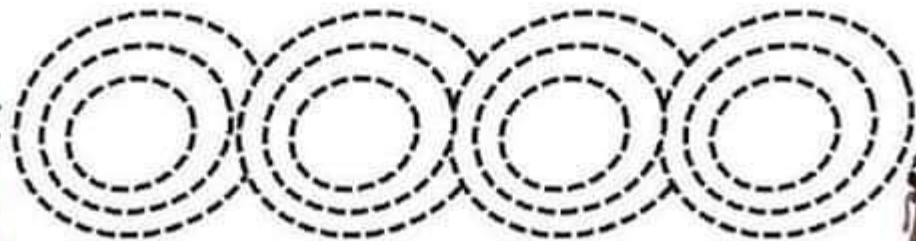
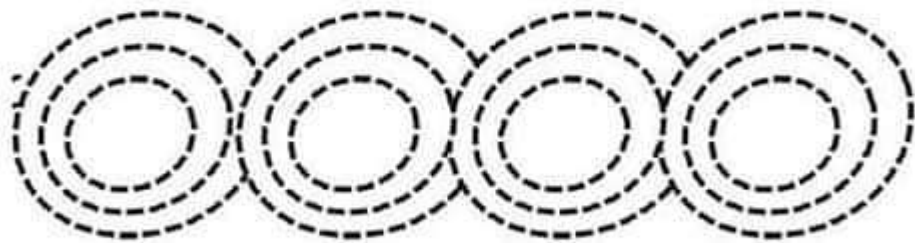
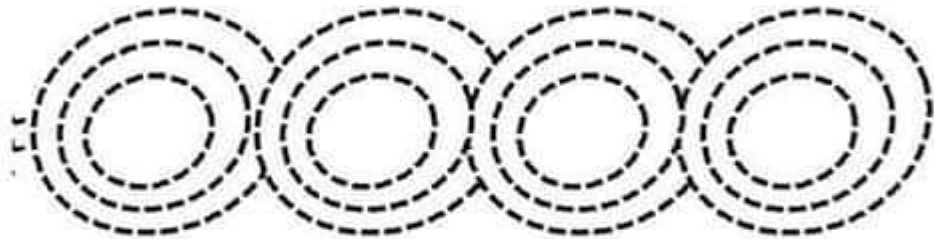
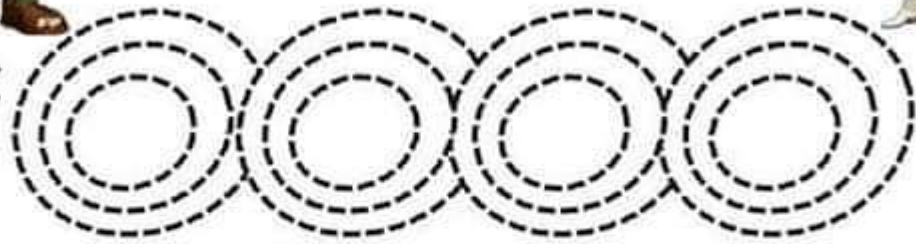



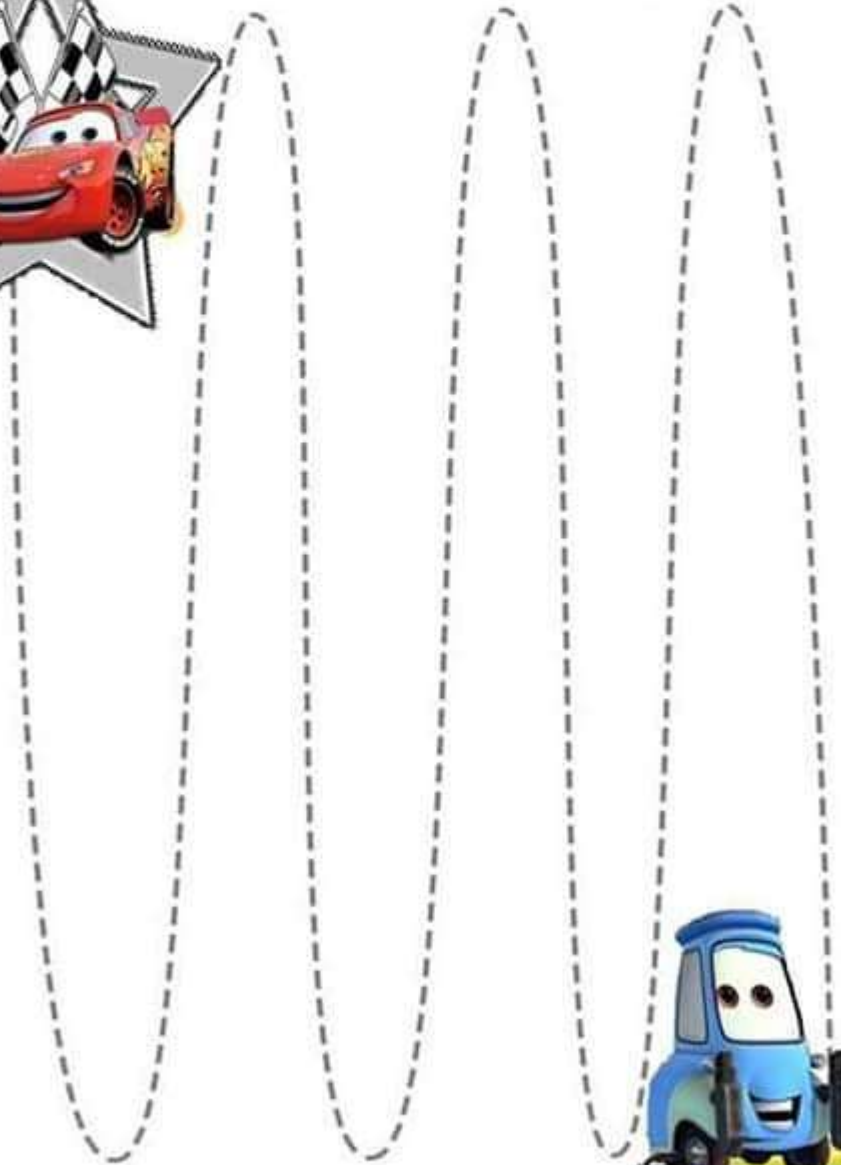



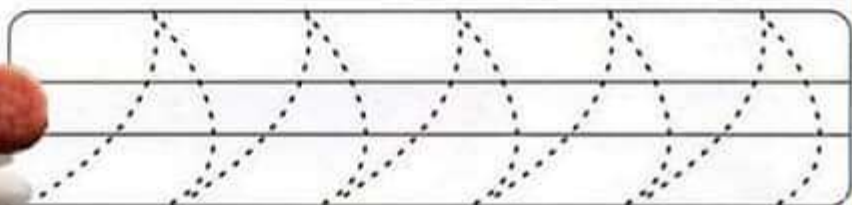
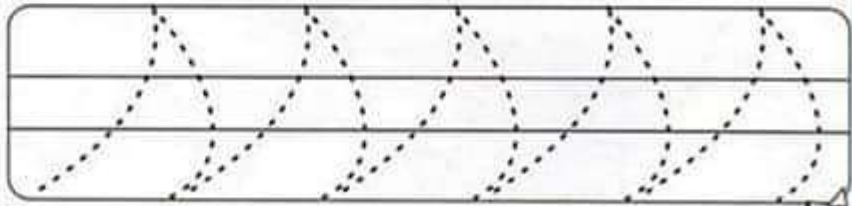
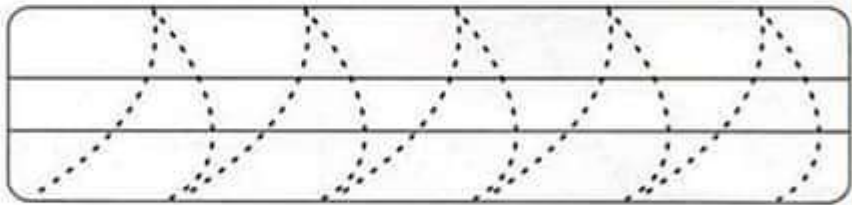
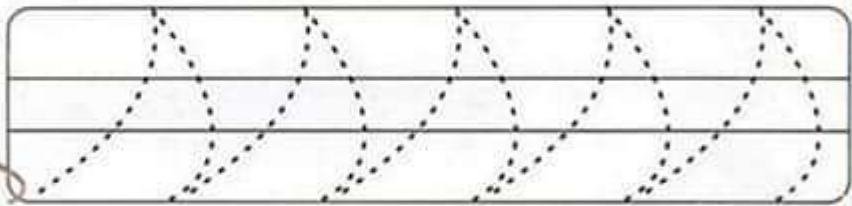
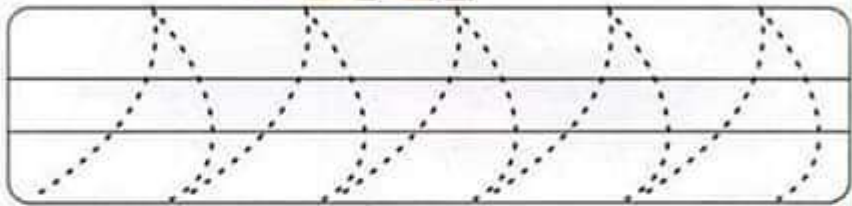

Disney · PIXAR  
**RATATOUILLE**





This worksheet is designed for tracing practice. It features a decorative border of small pink circles. The main content consists of four rows of dashed zigzag lines. The characters are distributed as follows:

- Top left: A yellow character with blue hair.
- Top right: A pink character with a purple bag.
- Middle left: A purple character with a long neck.
- Middle right: A green character with a green dress.
- Bottom left: A red character with a mask.
- Bottom right: A blue character with glasses.
- Bottom center: A group of five characters including the yellow, green, red, and blue characters, along with the purple character.

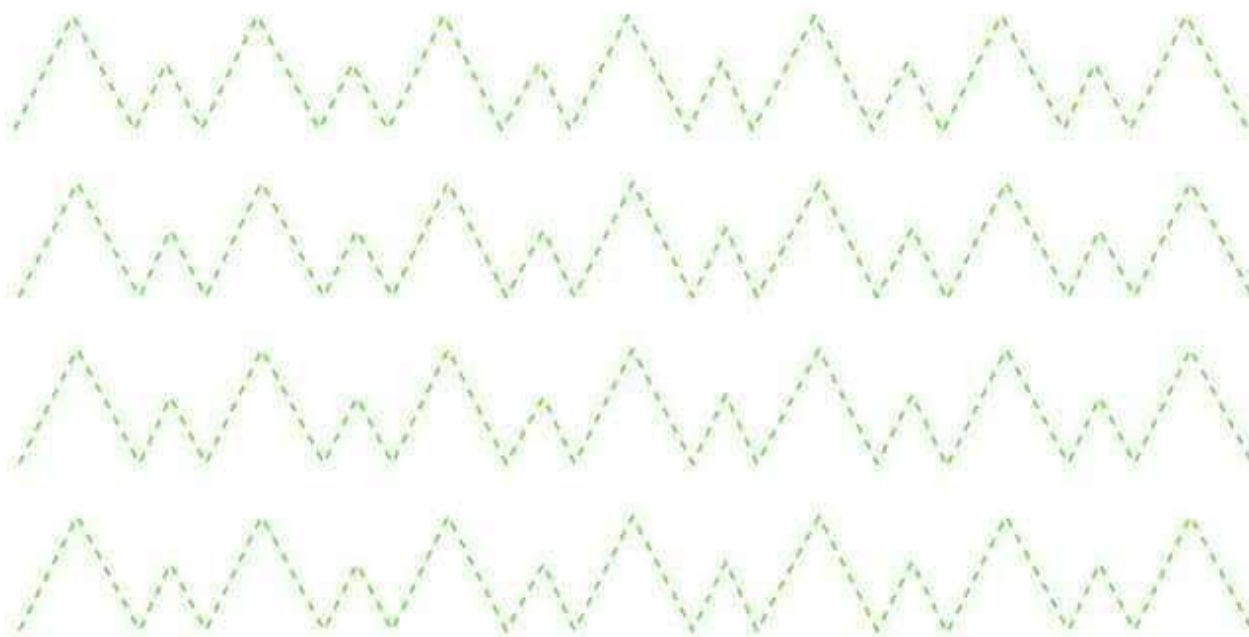
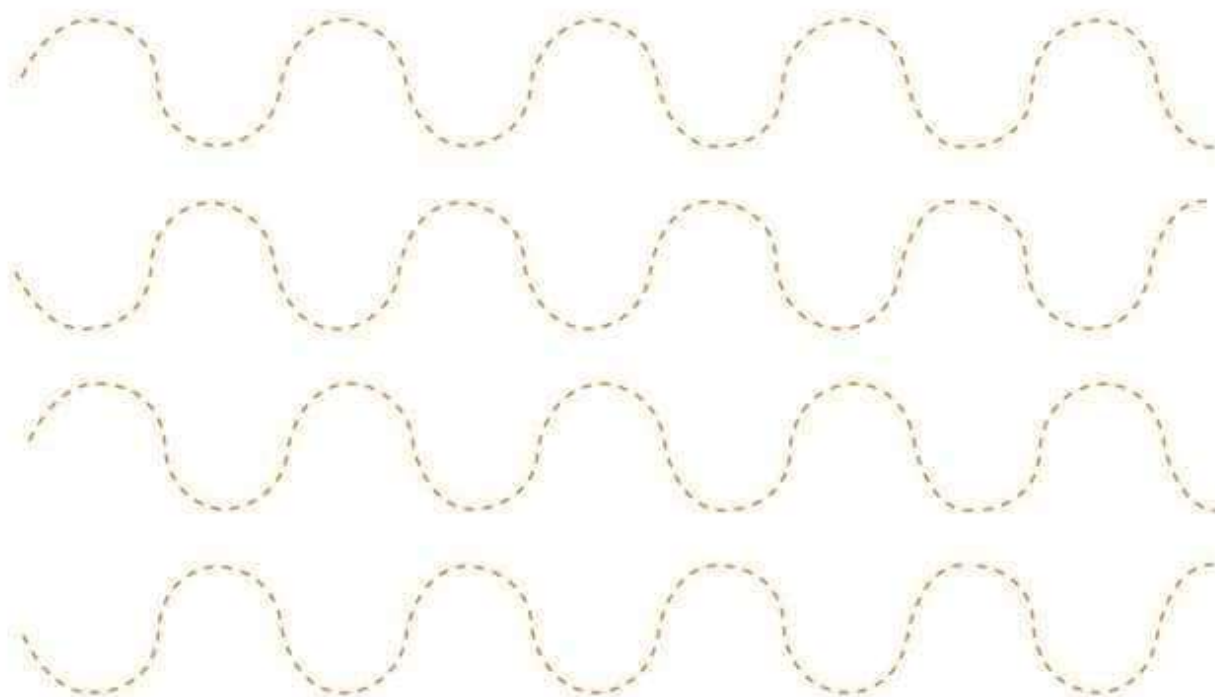



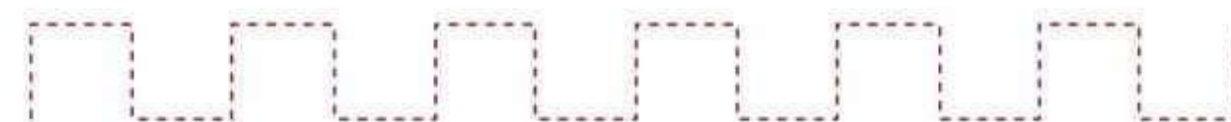
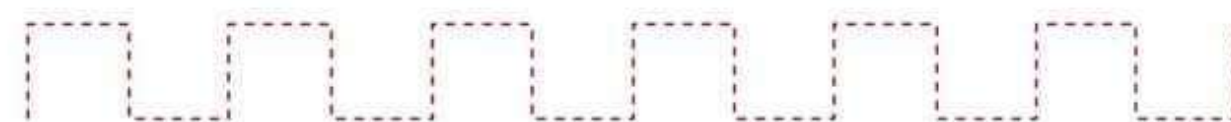

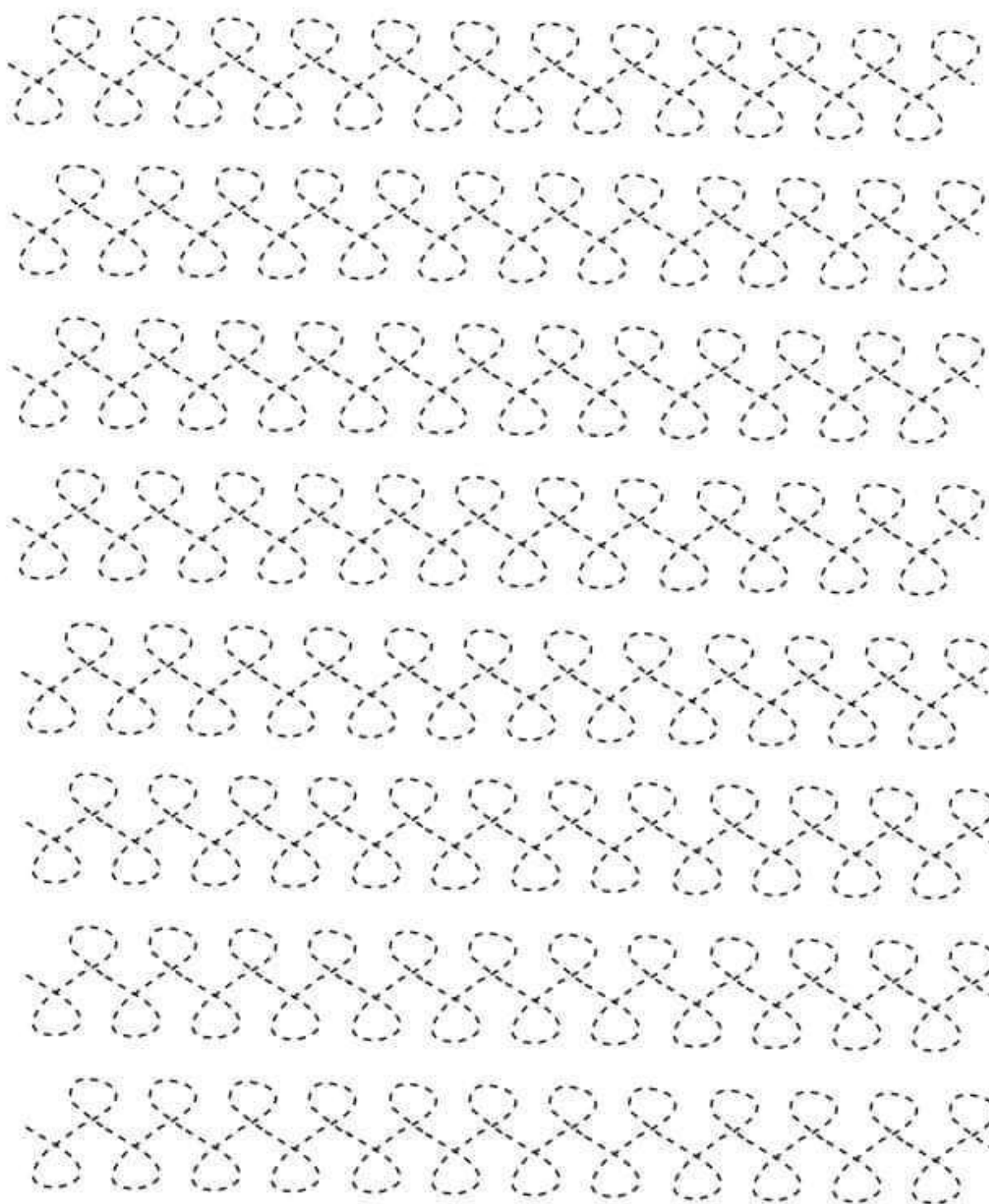

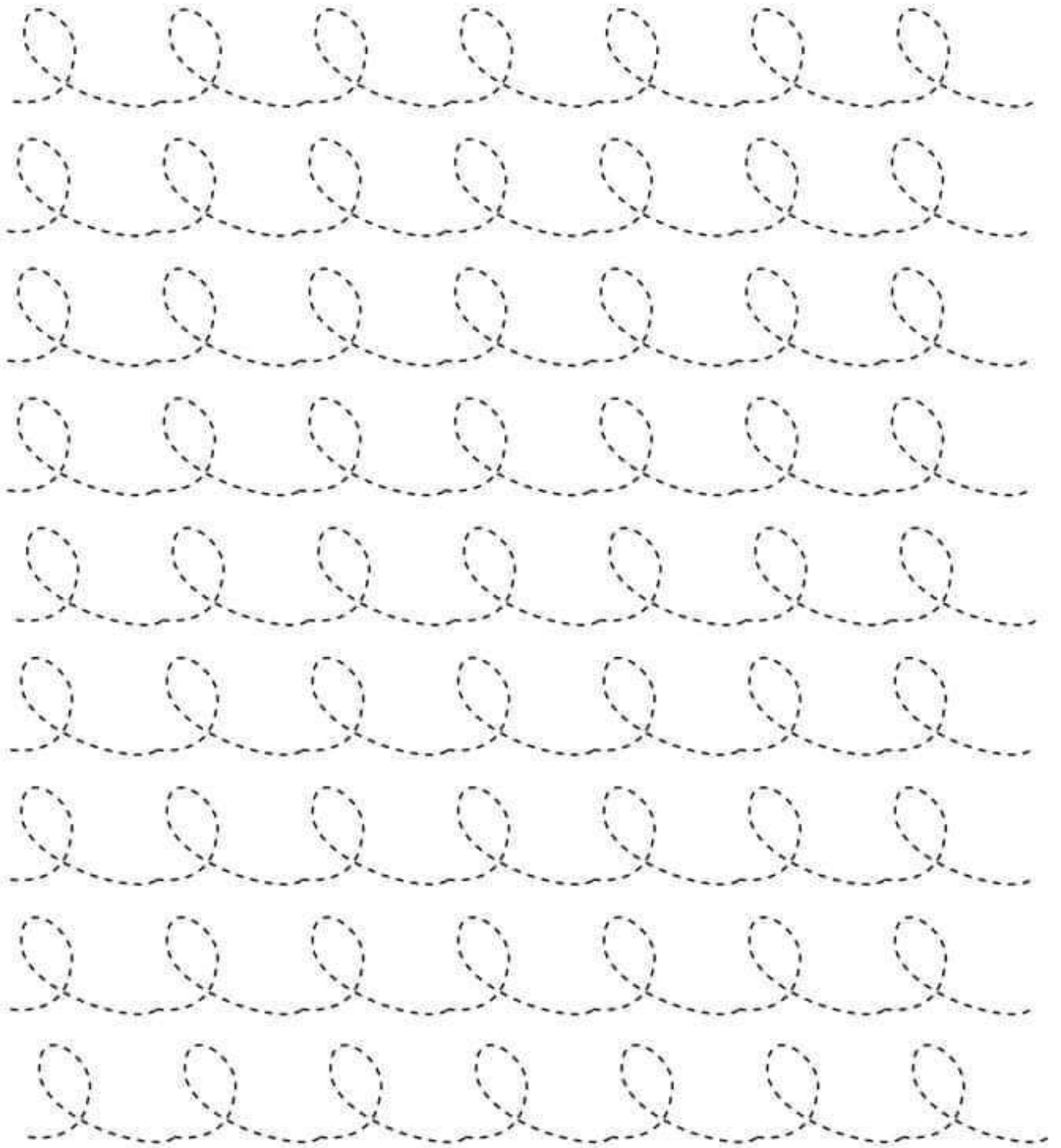

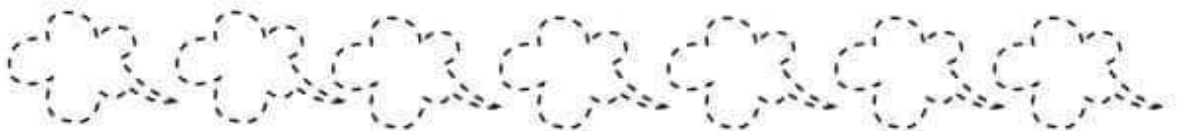
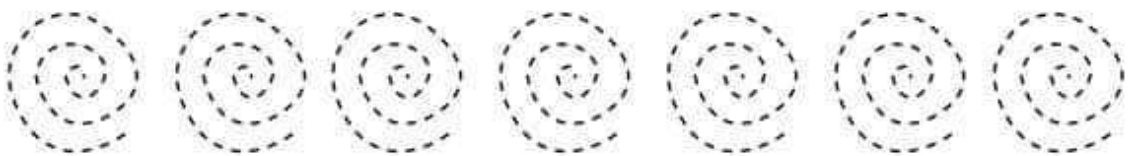
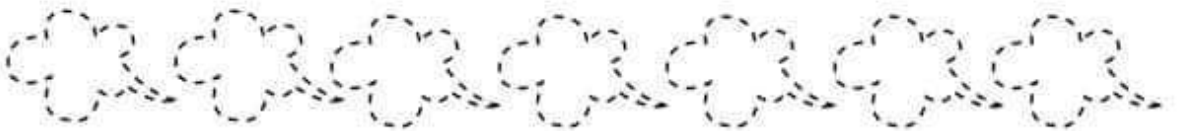
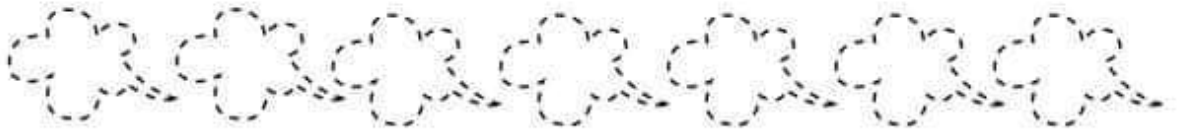
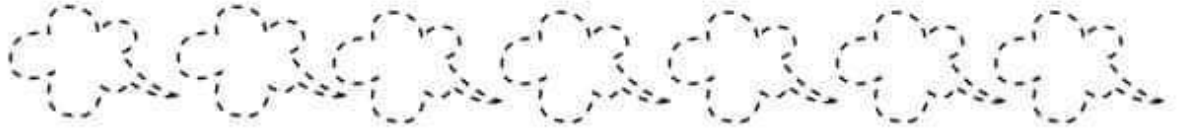

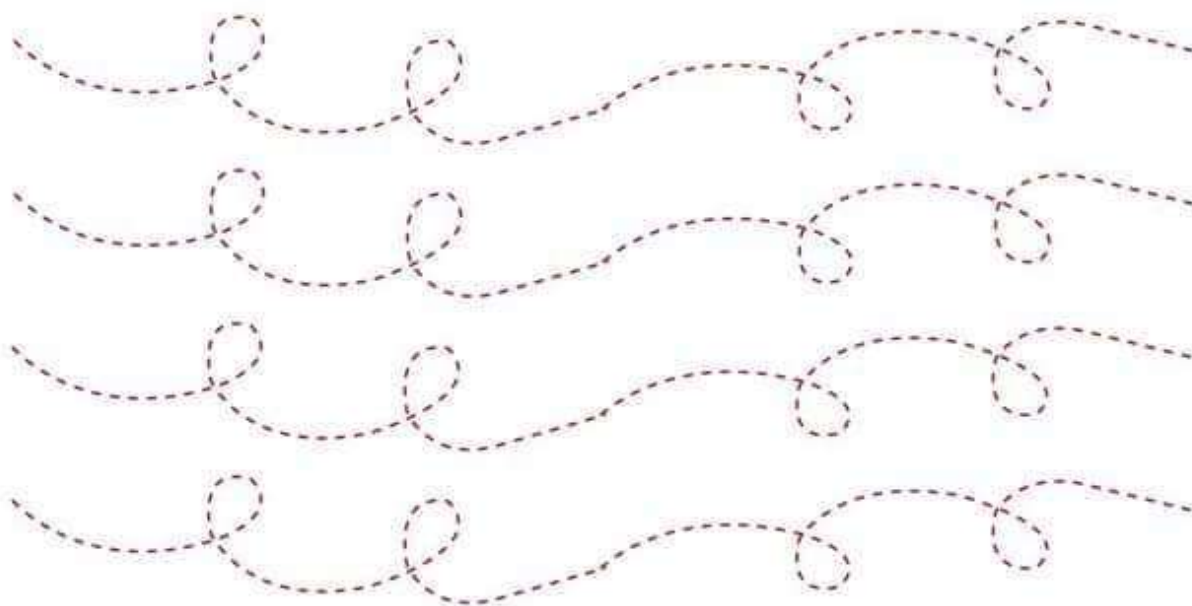
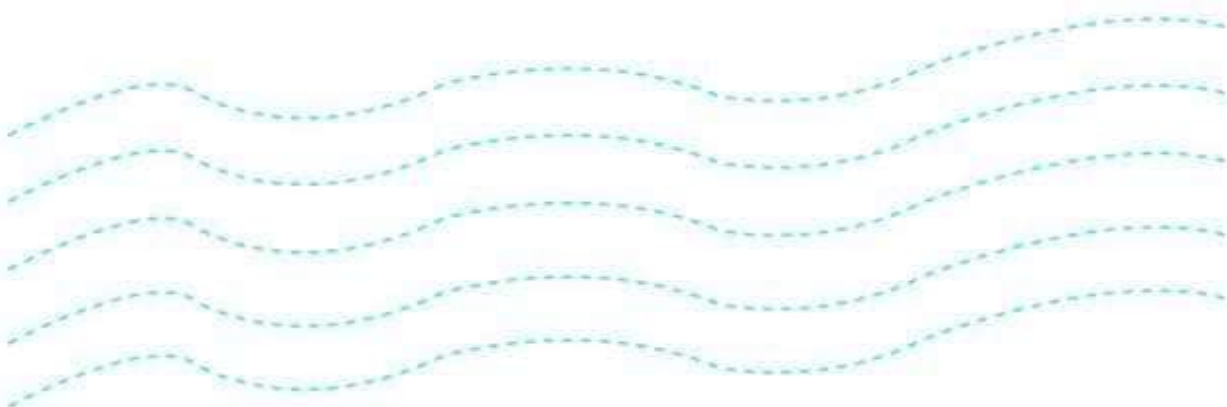

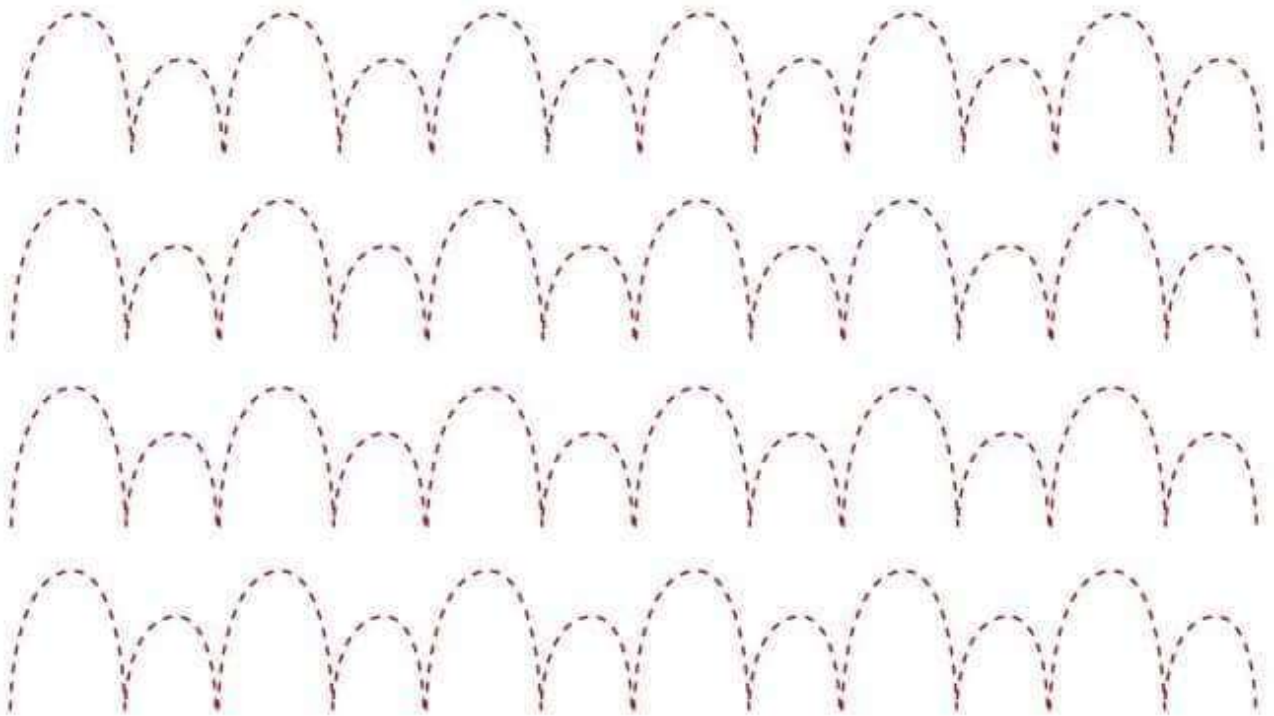
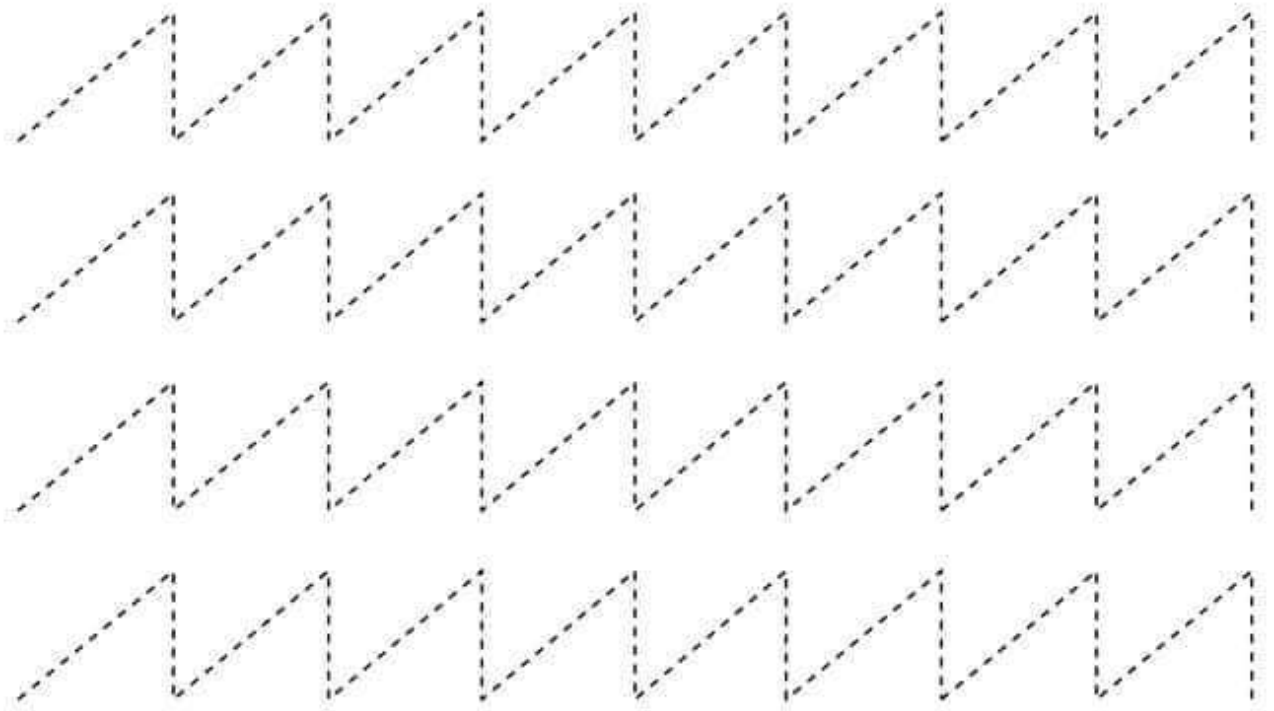







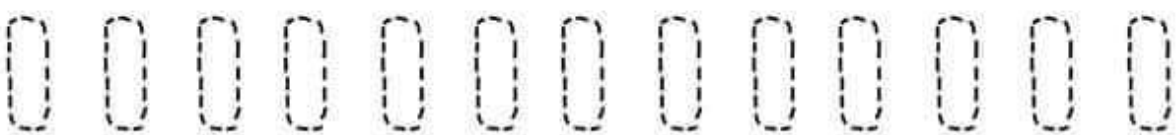
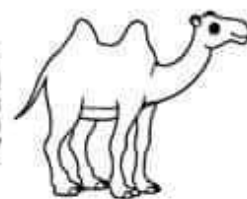
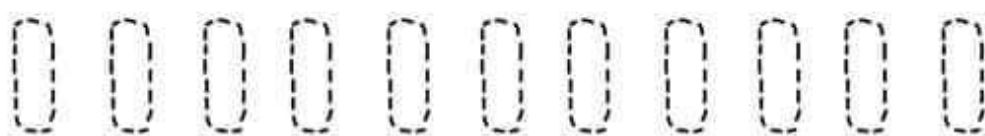

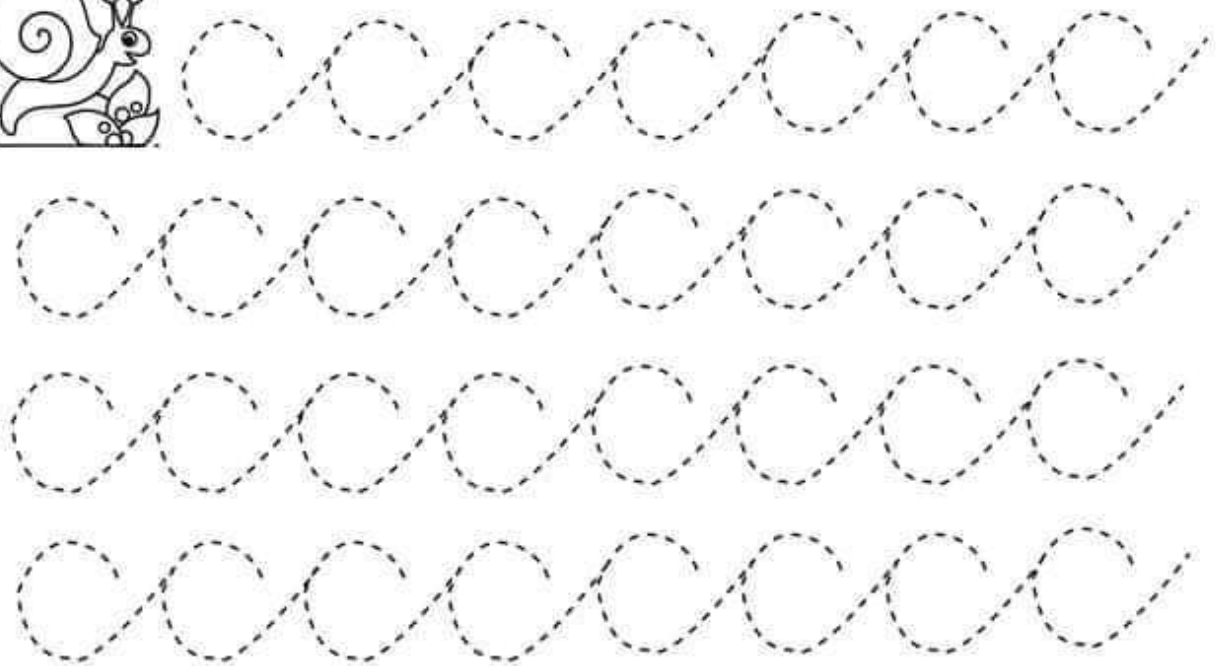
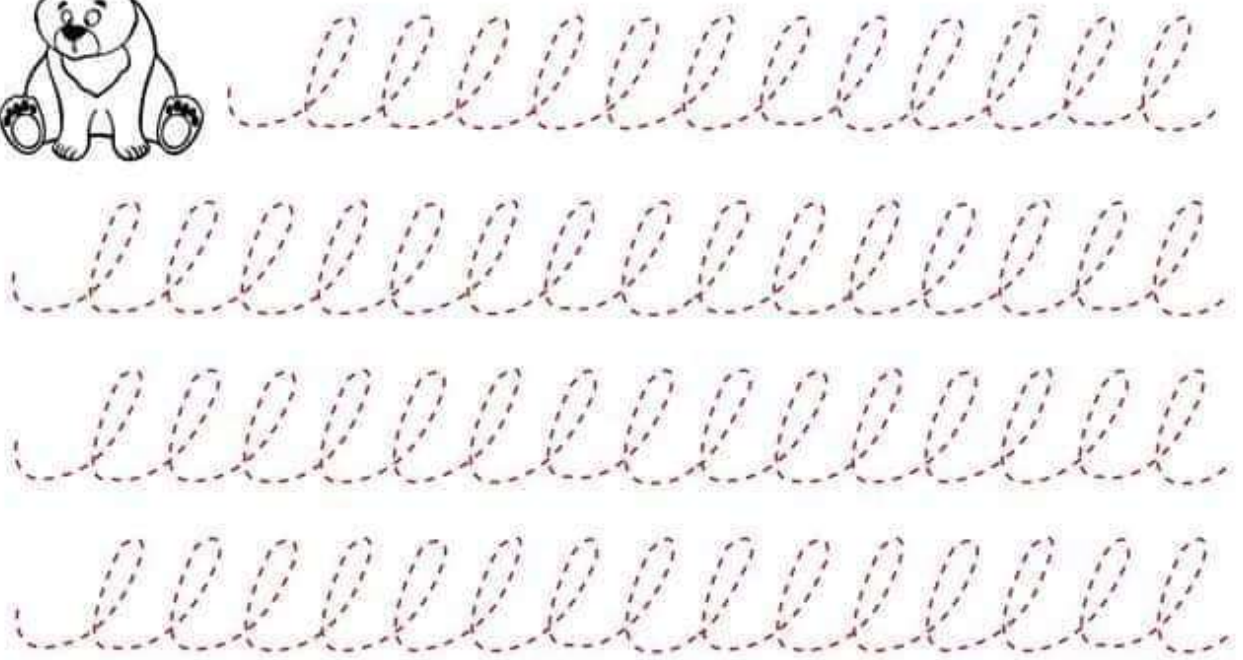

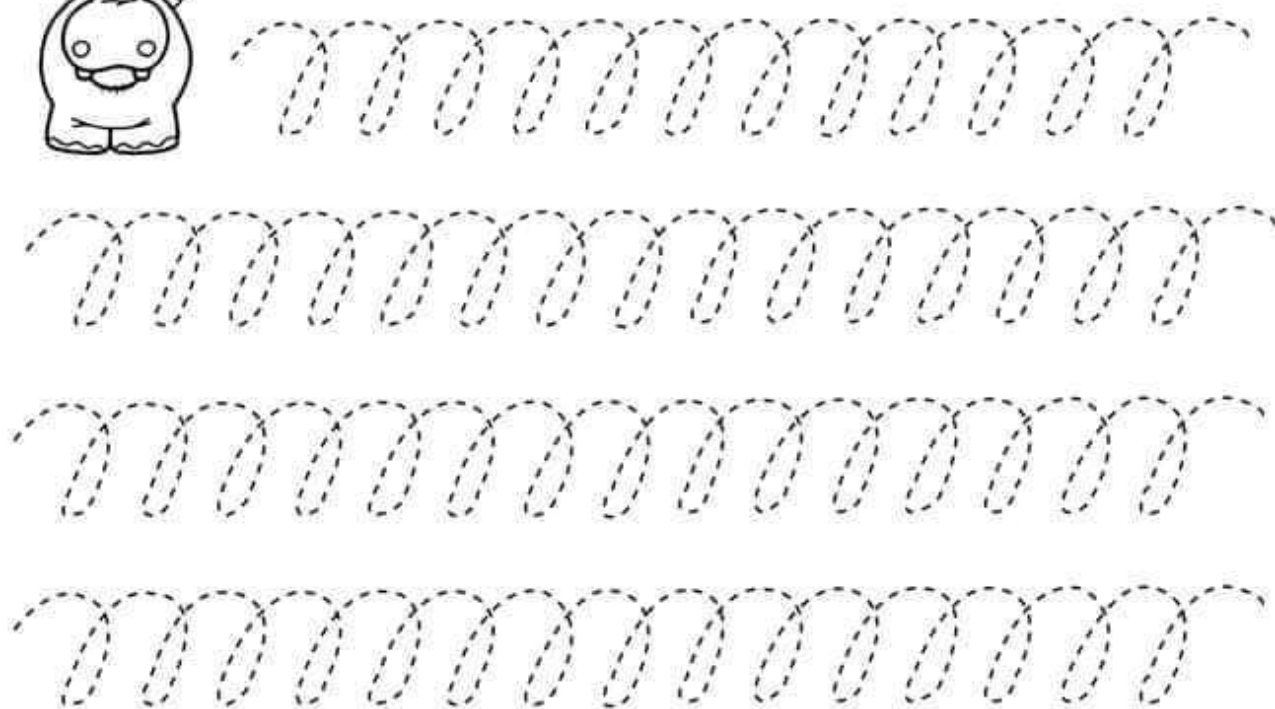
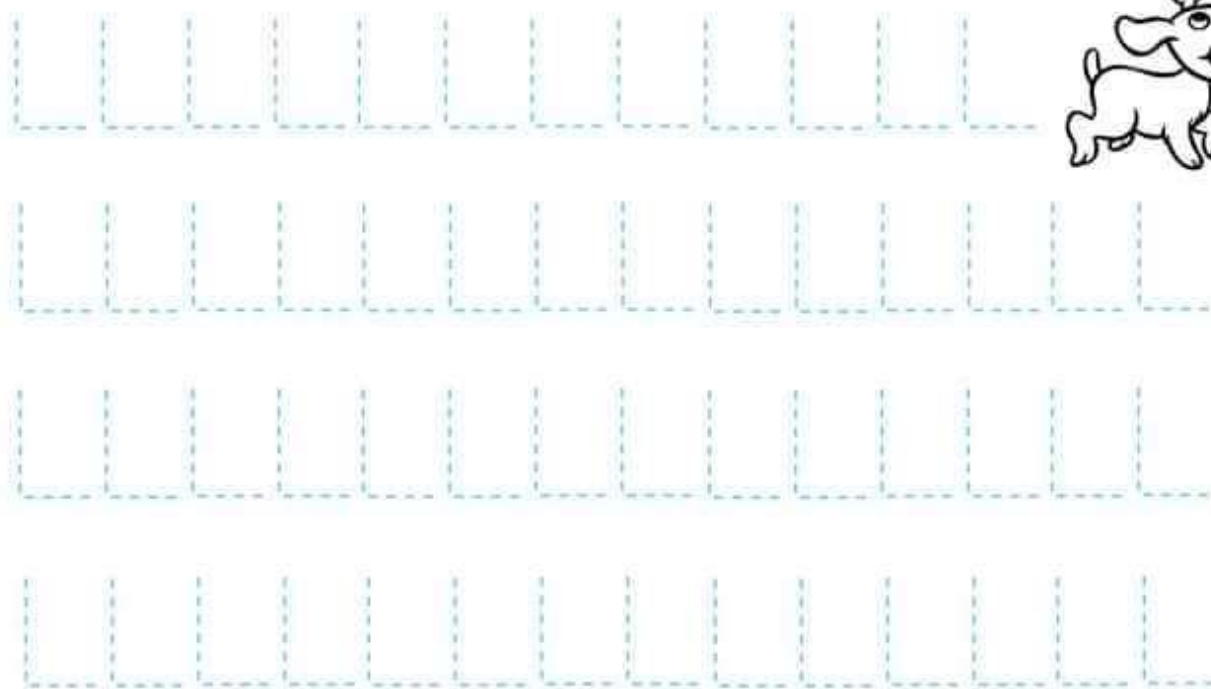

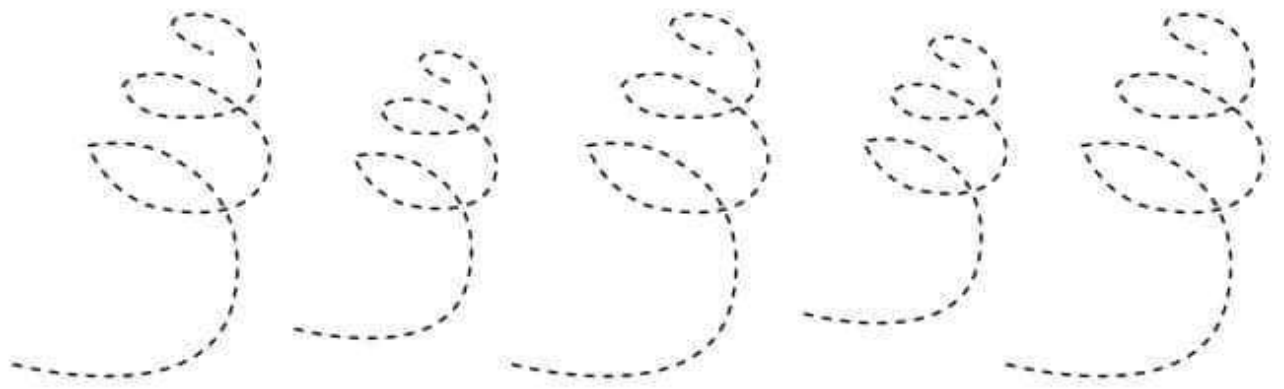
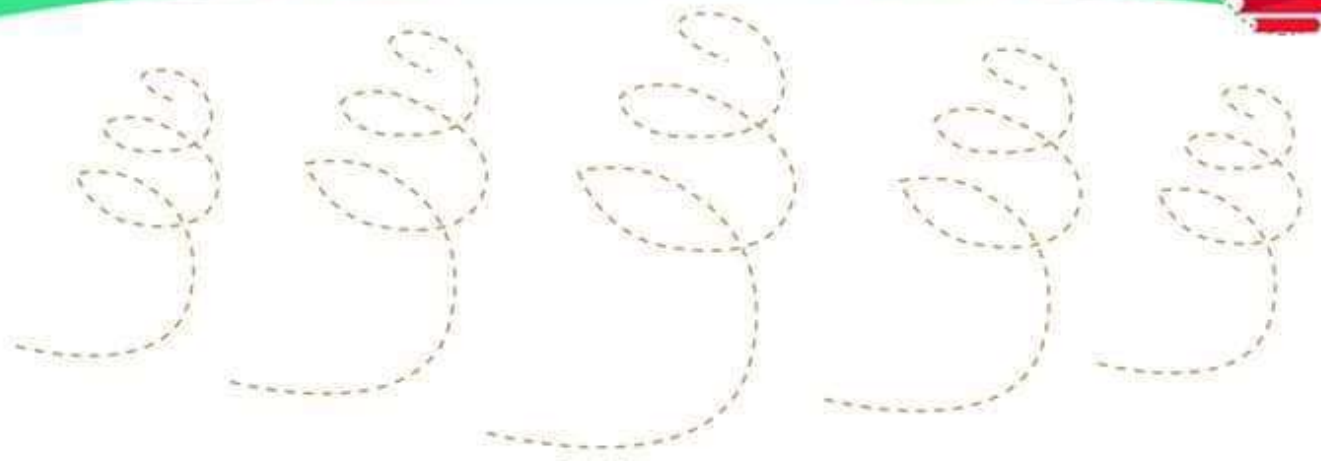

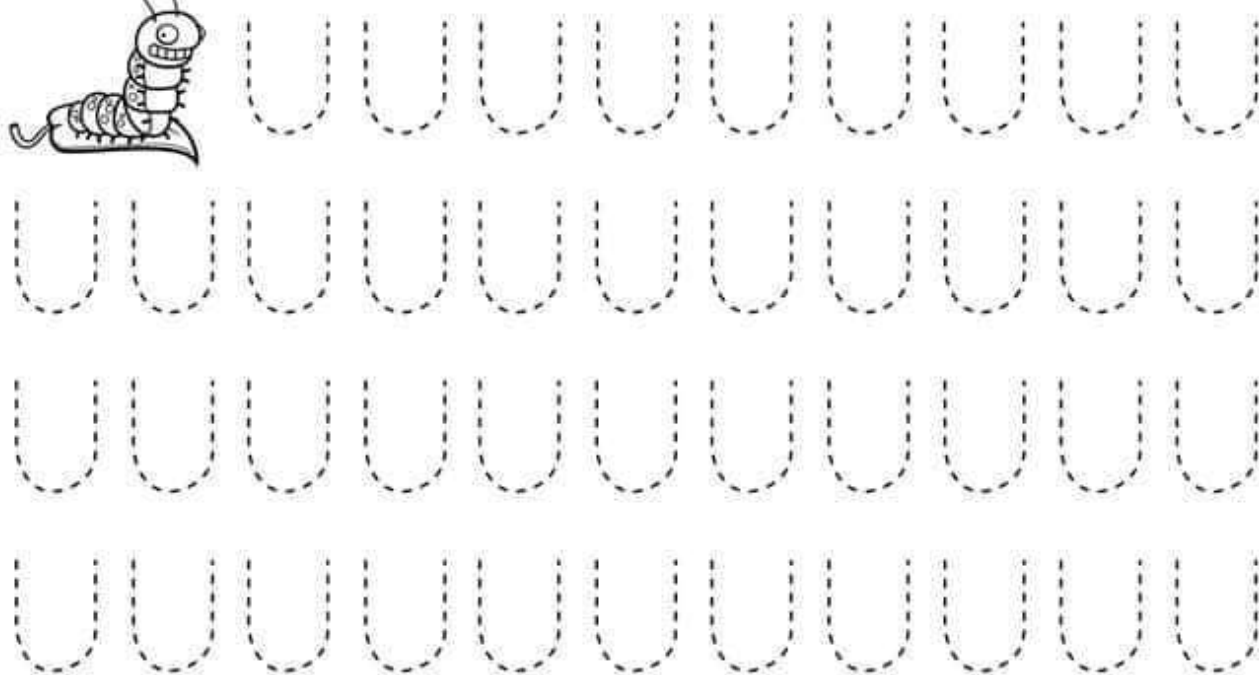

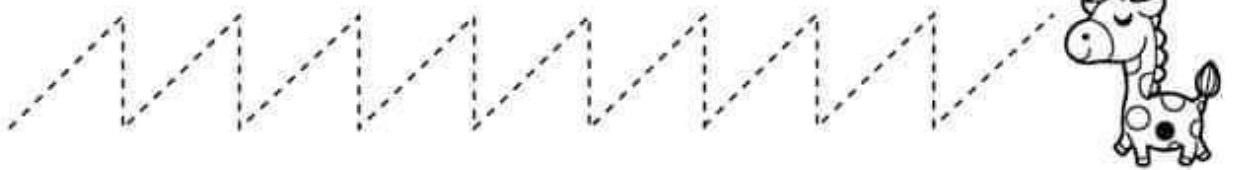

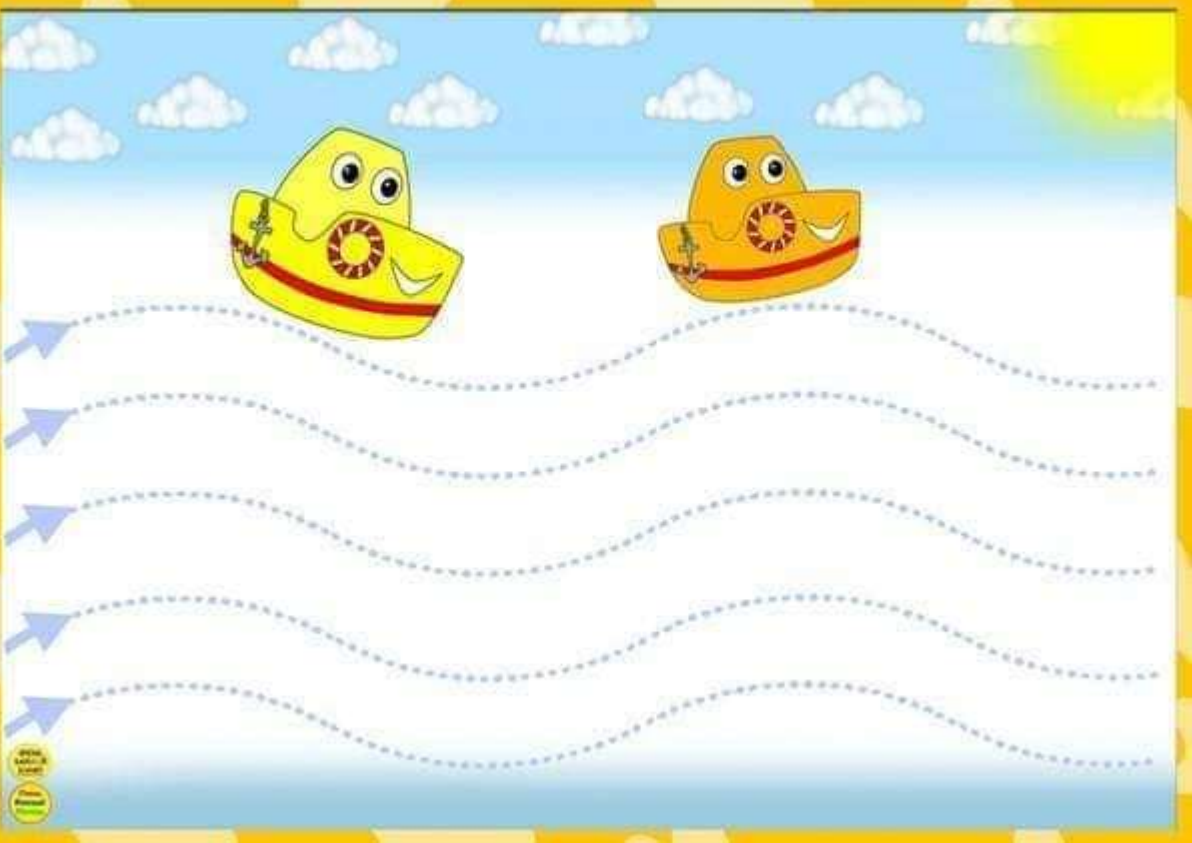
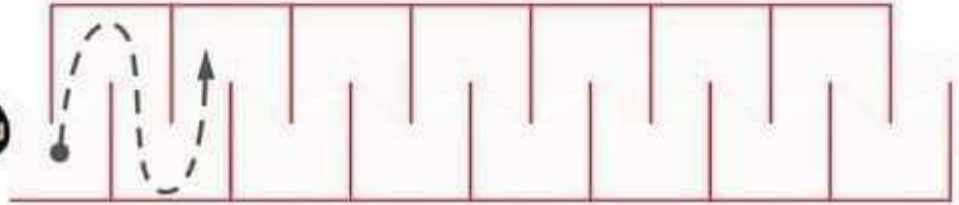
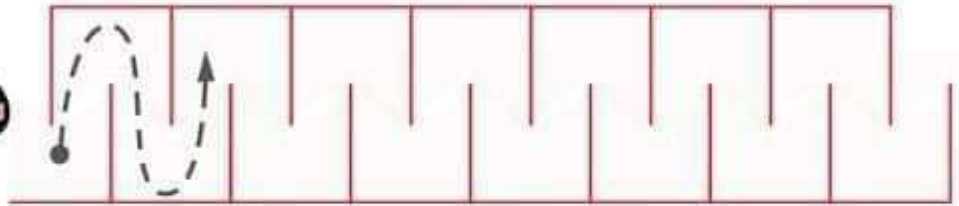
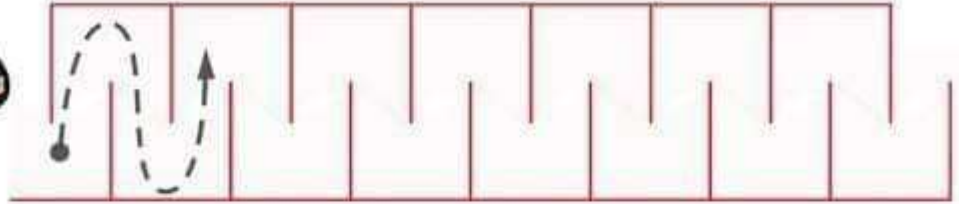

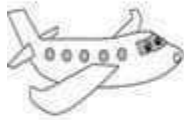

A large rectangular grid with a blue border containing five rows of tracing exercises. Each row starts with a colorful race car (yellow, green, blue, orange, purple) and is followed by a dashed wavy line with six yellow, green, blue, orange, and purple traffic cones respectively. A small yellow circular logo is in the bottom left corner of the grid.



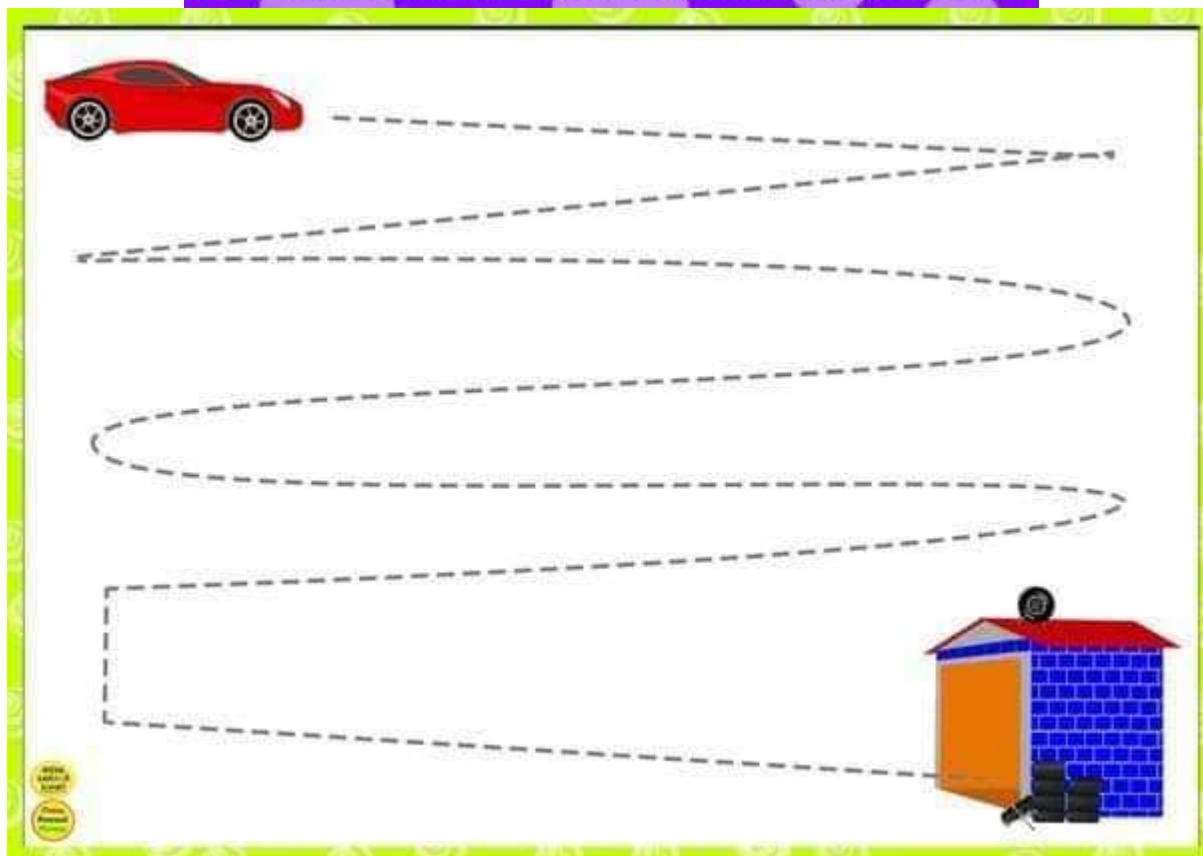
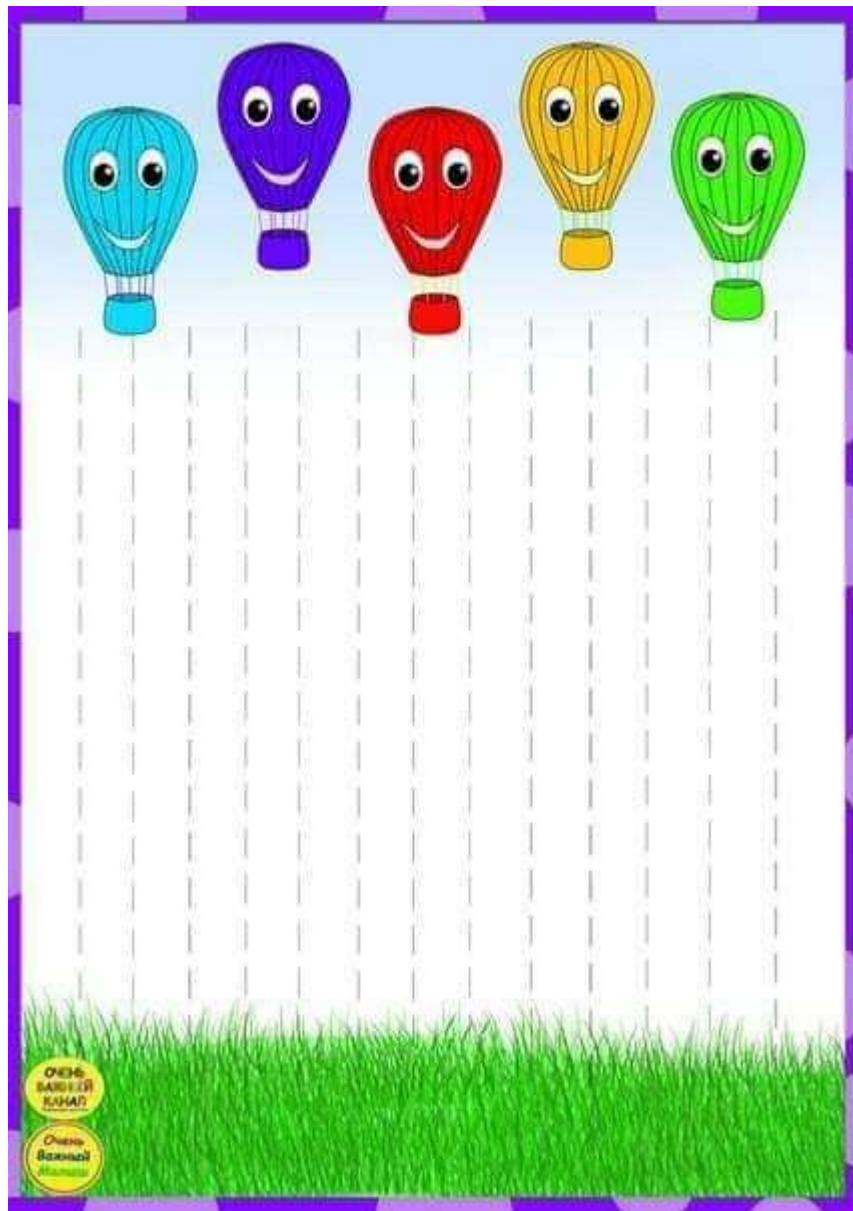

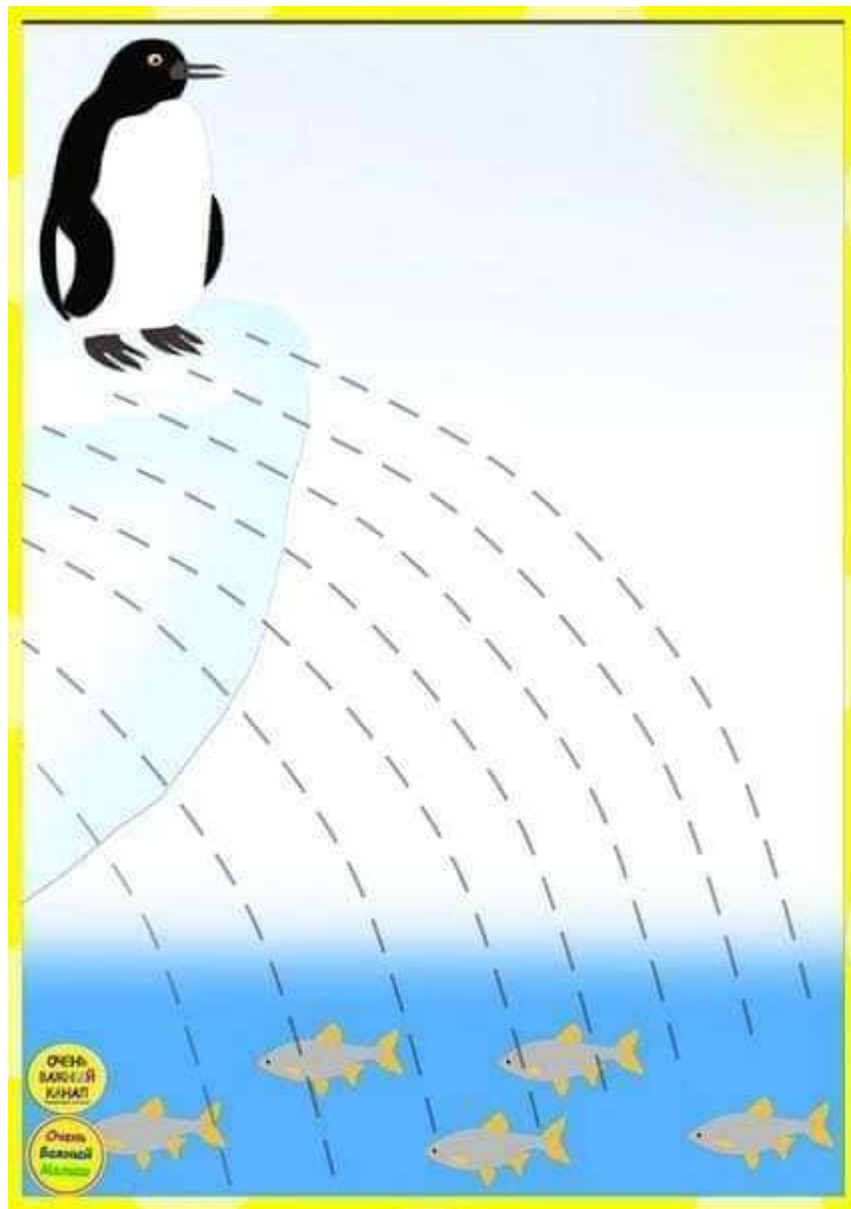

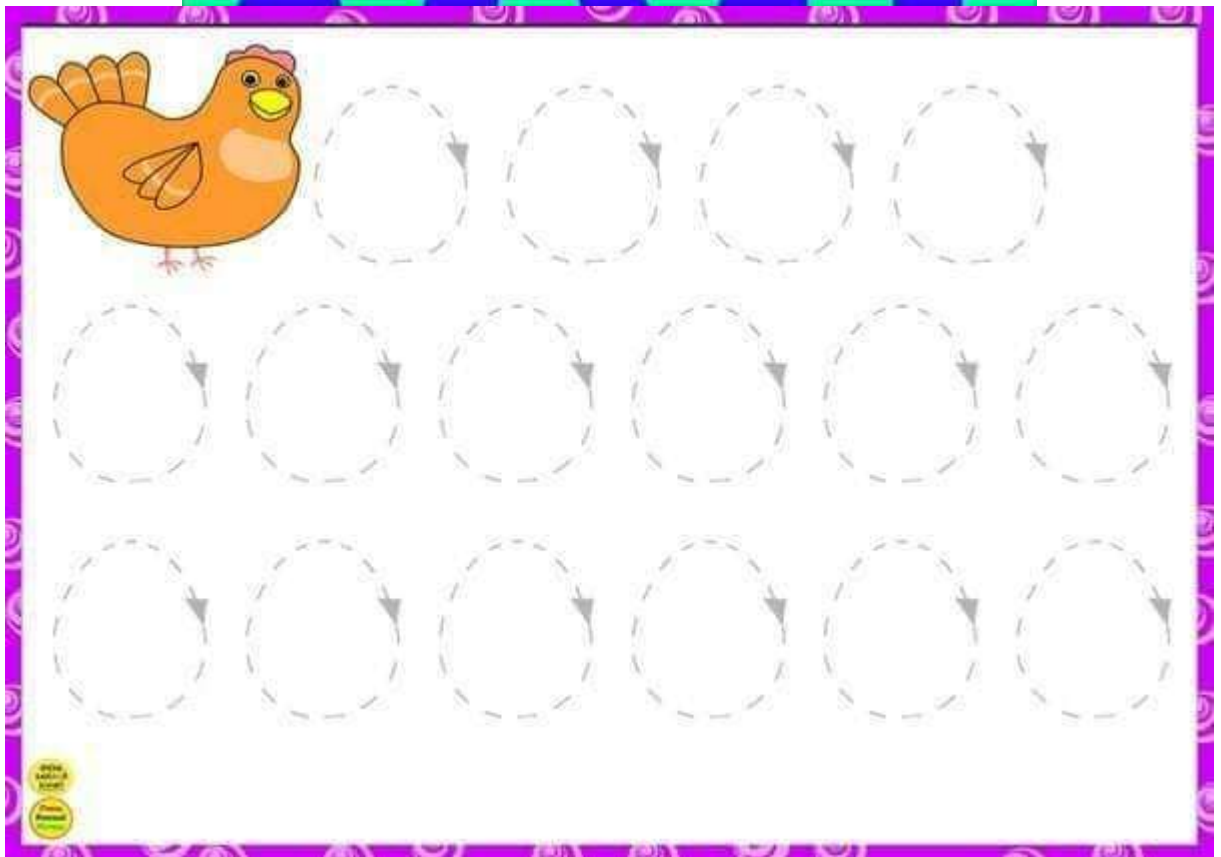
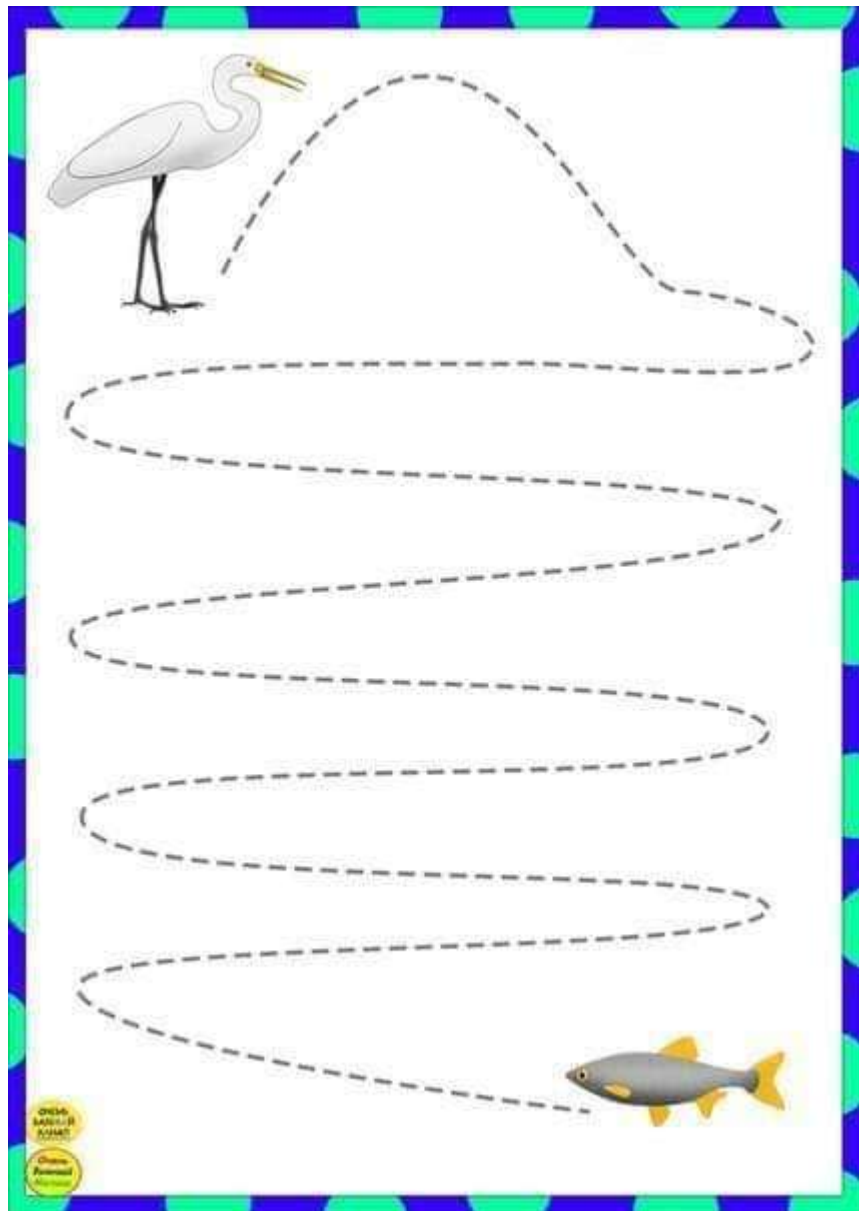

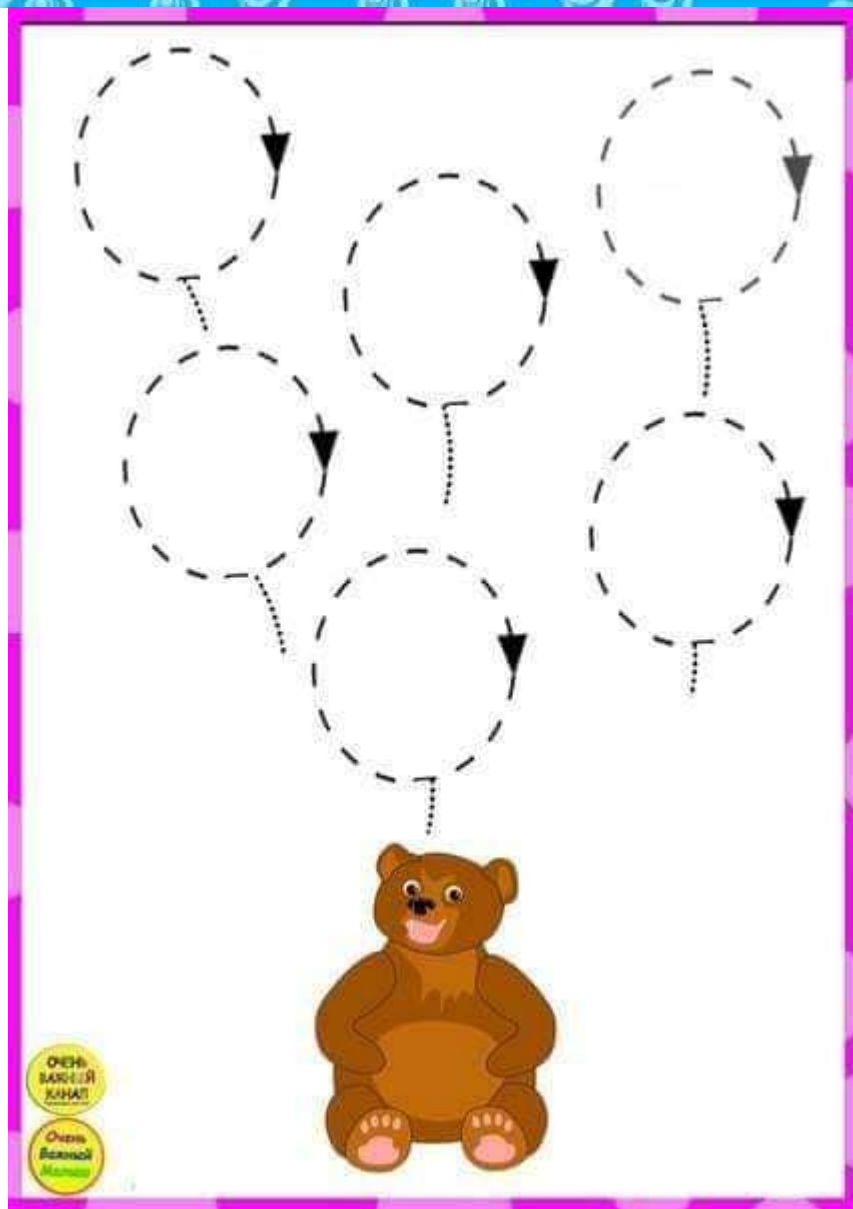
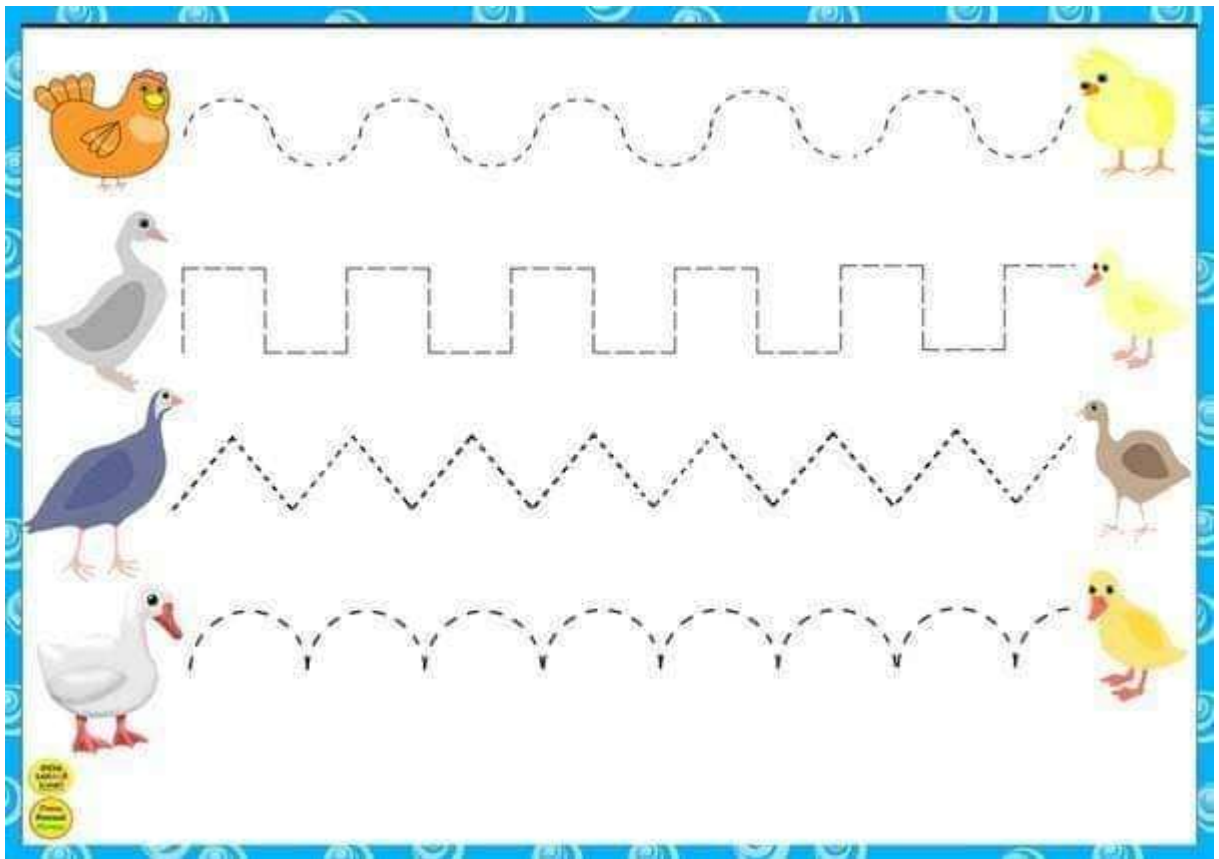

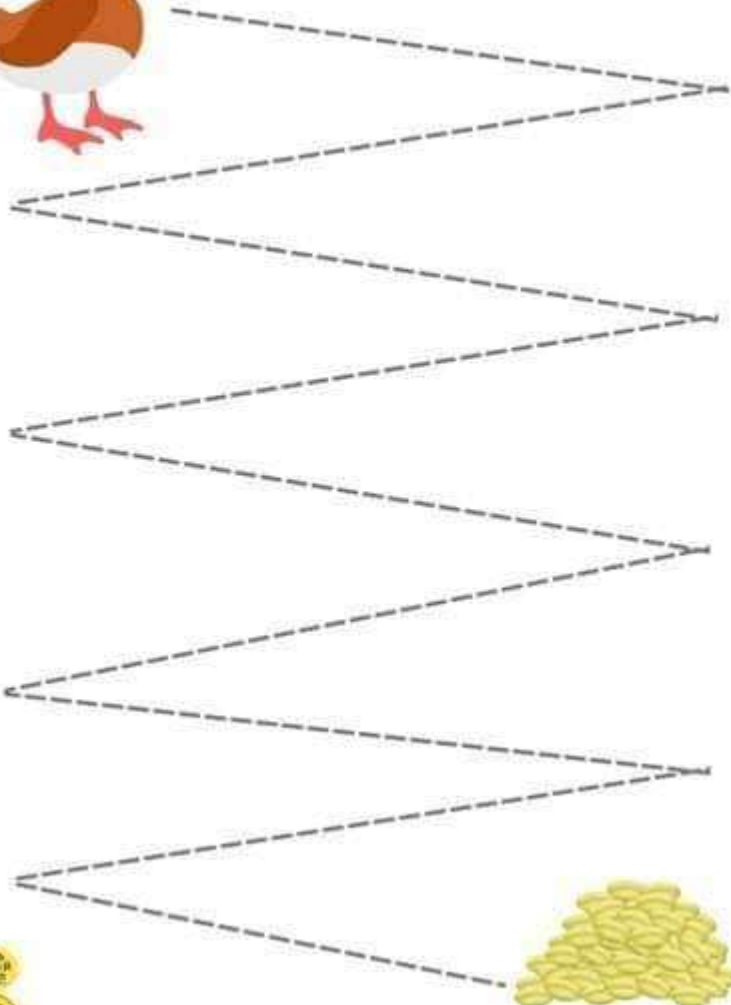

©2010  
KIDZ  
KIDZ  
KIDZ  
KIDZ  
KIDZ

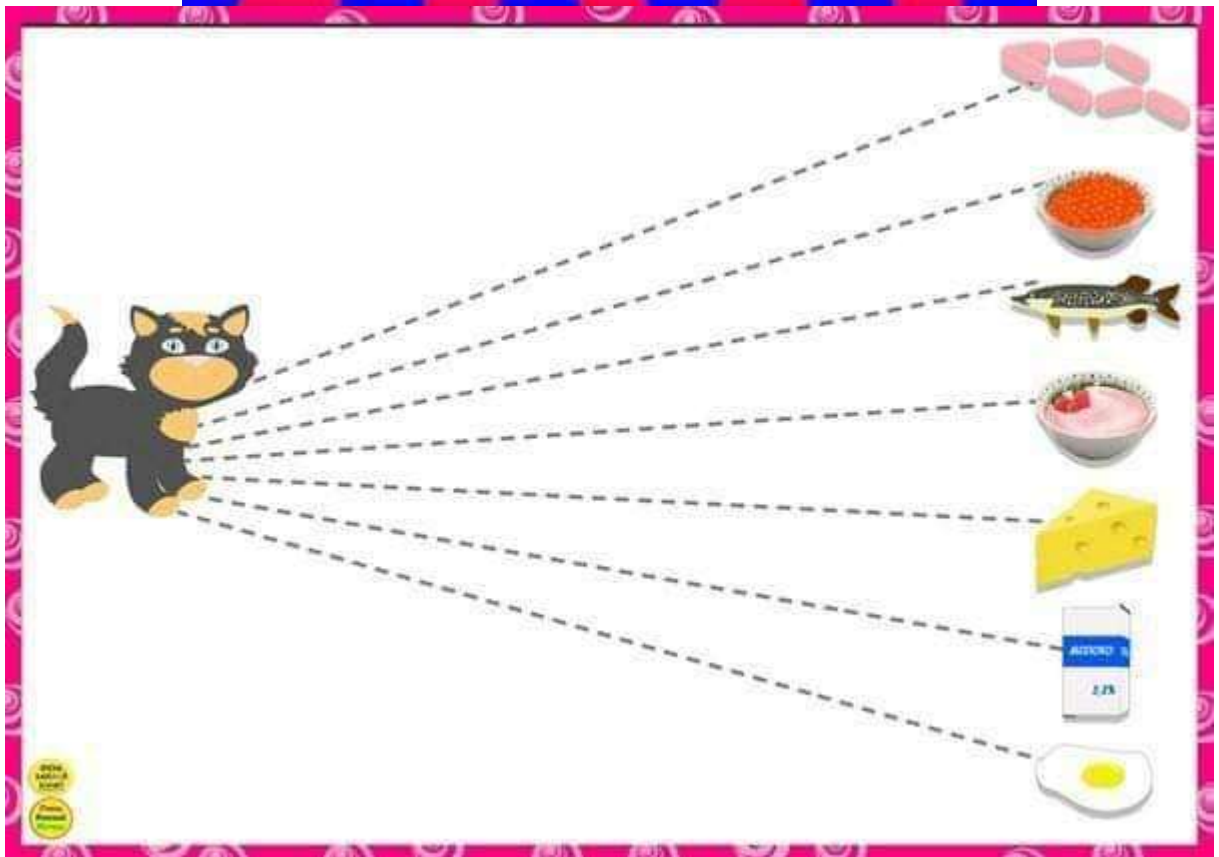
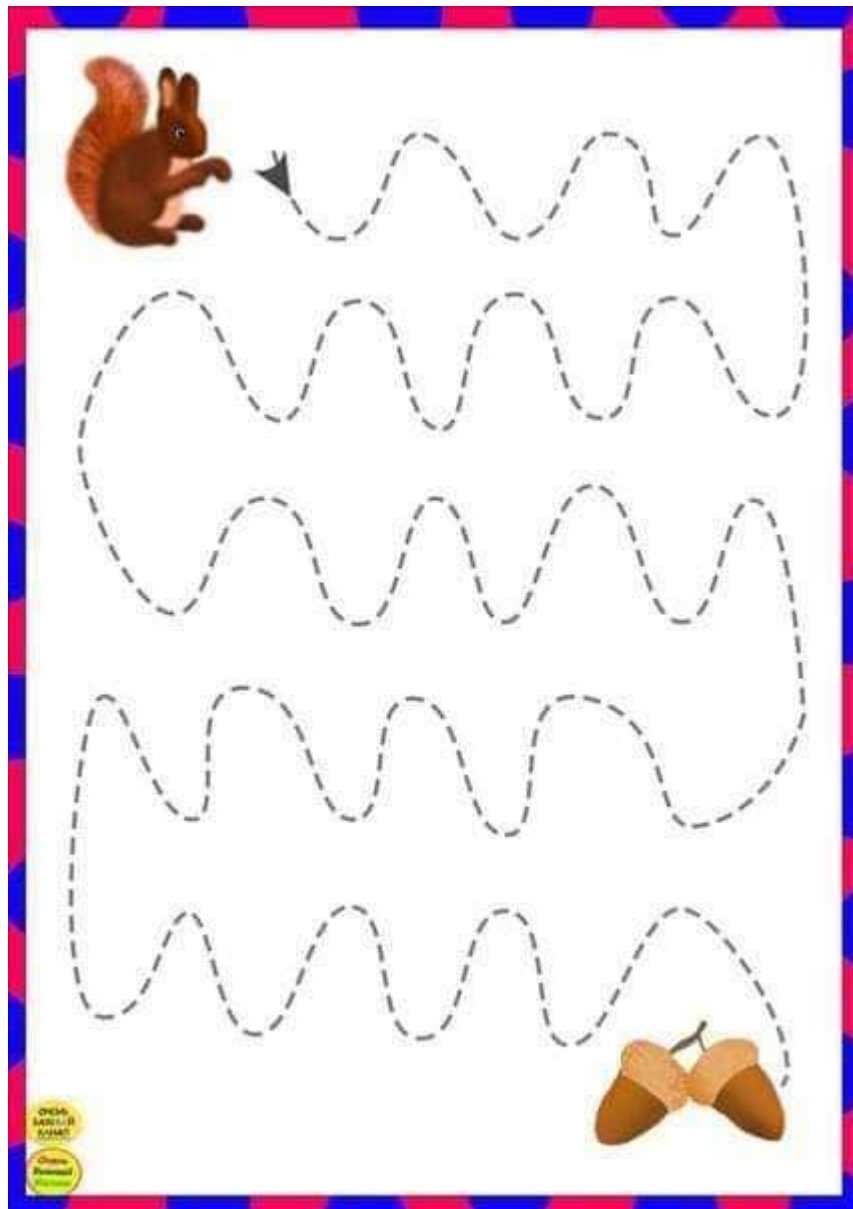

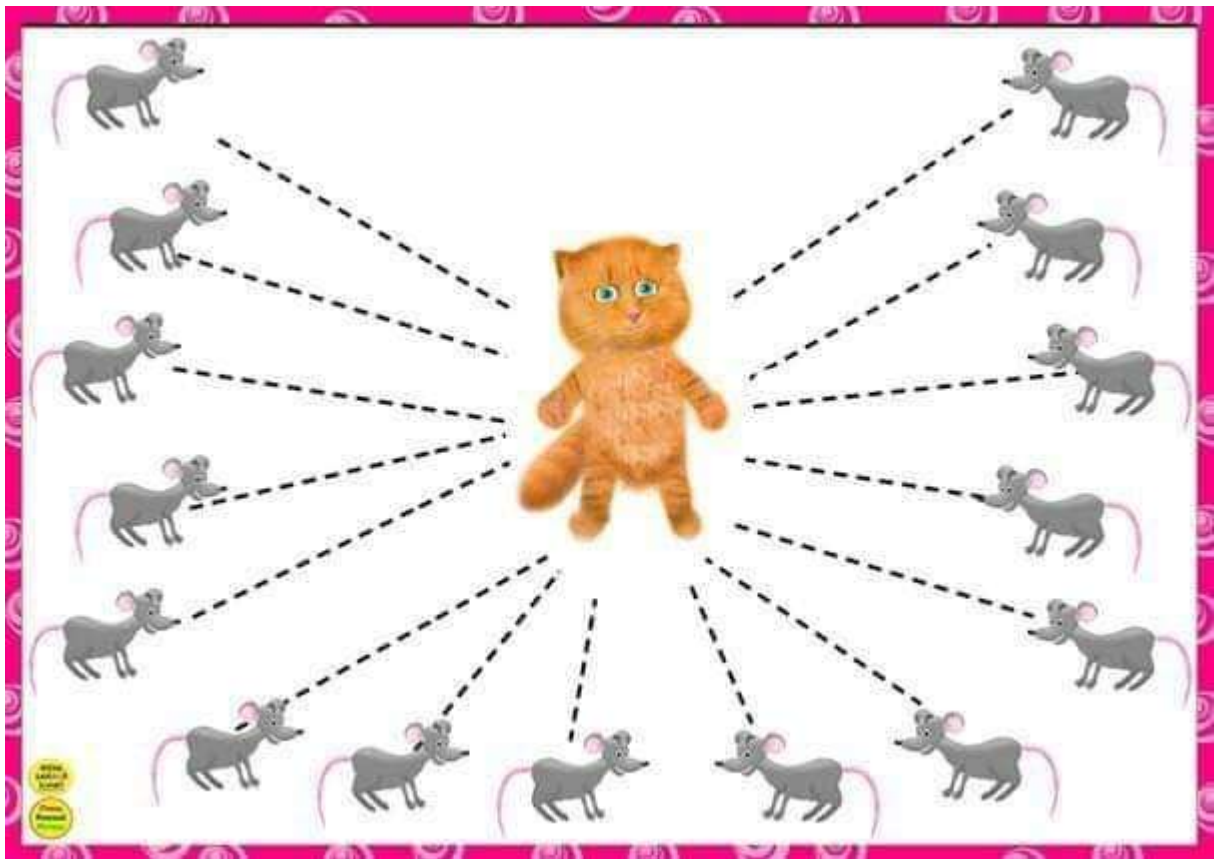

Langs welke weg raakt de dokter naar zijn patiënten?  
(oog-hand coördinatie)

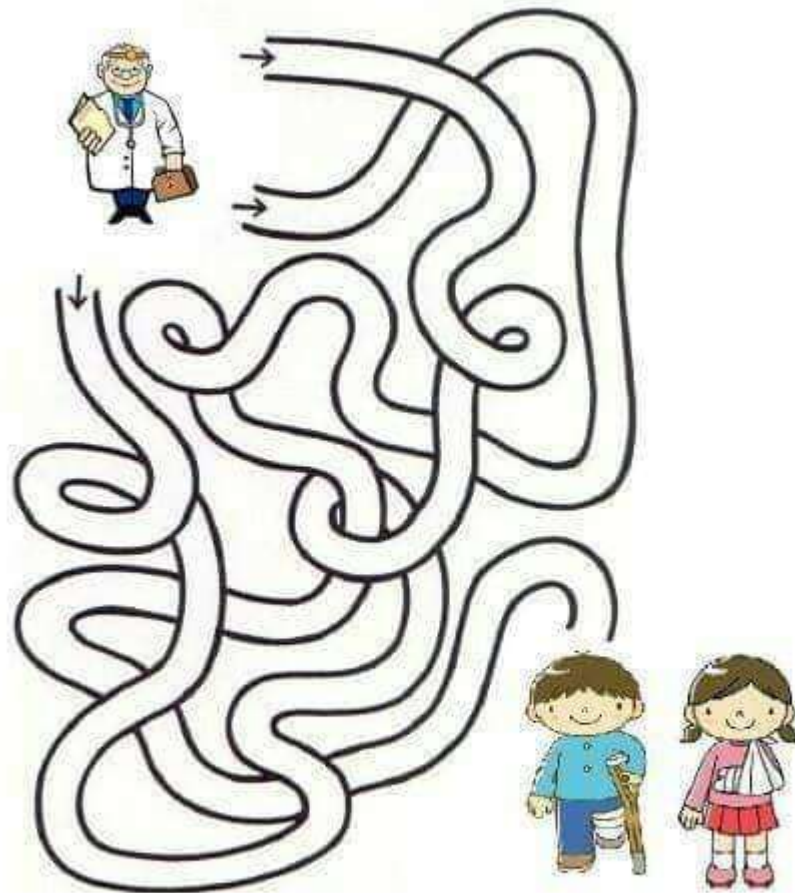

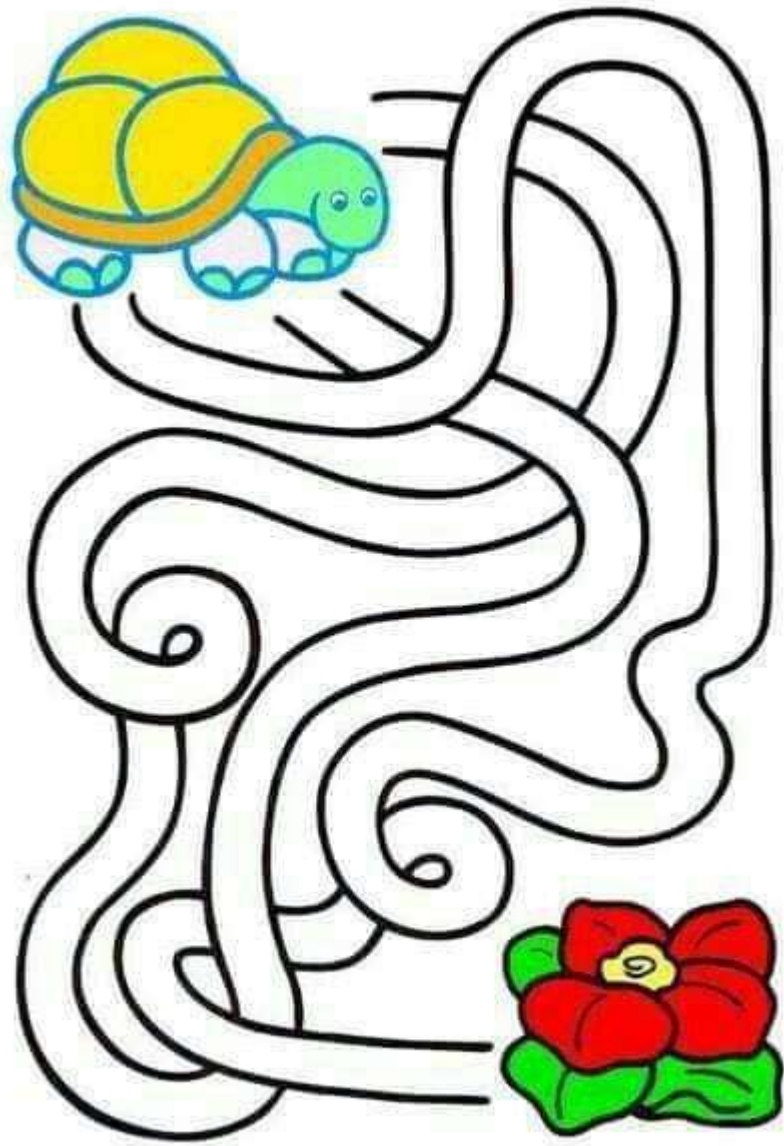

Григорий Александрович Мухоморов из Алматы.

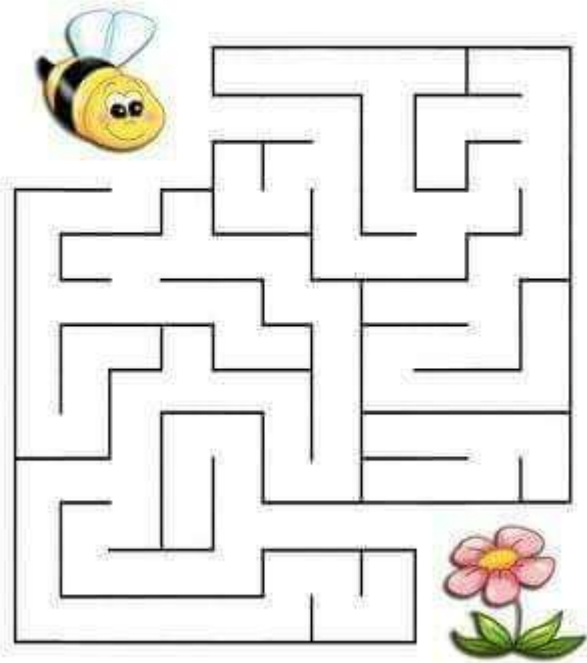



Name : \_\_\_\_\_

## MAZE ACTIVITIES

Hi kids, where is my eggs?

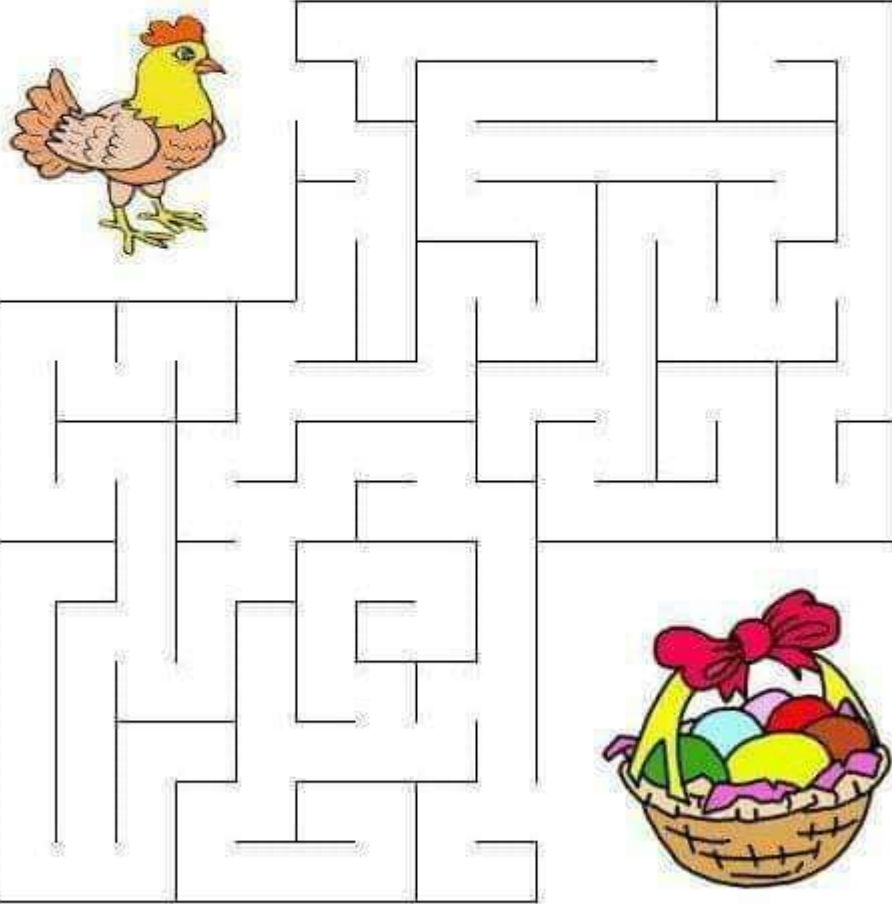

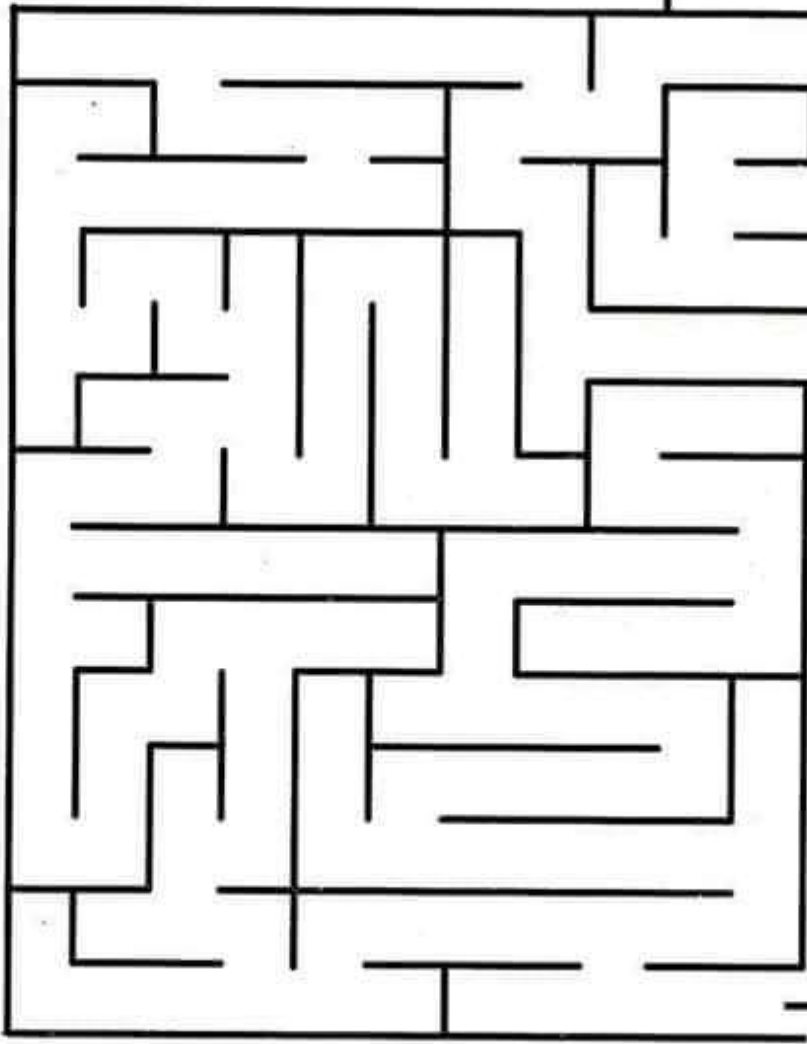
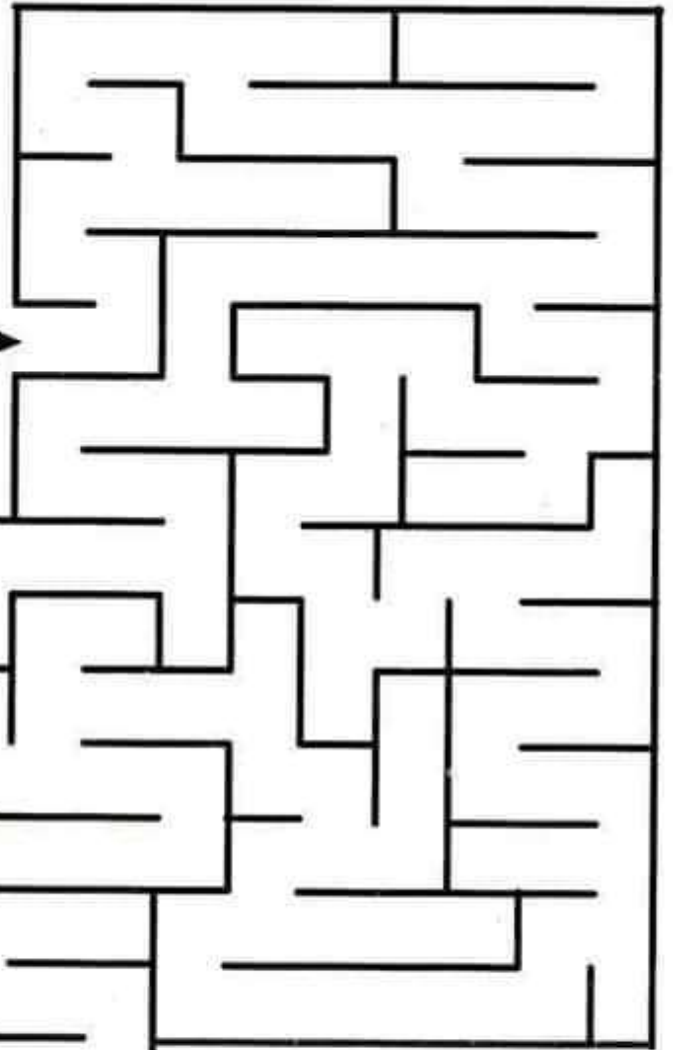

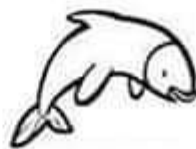
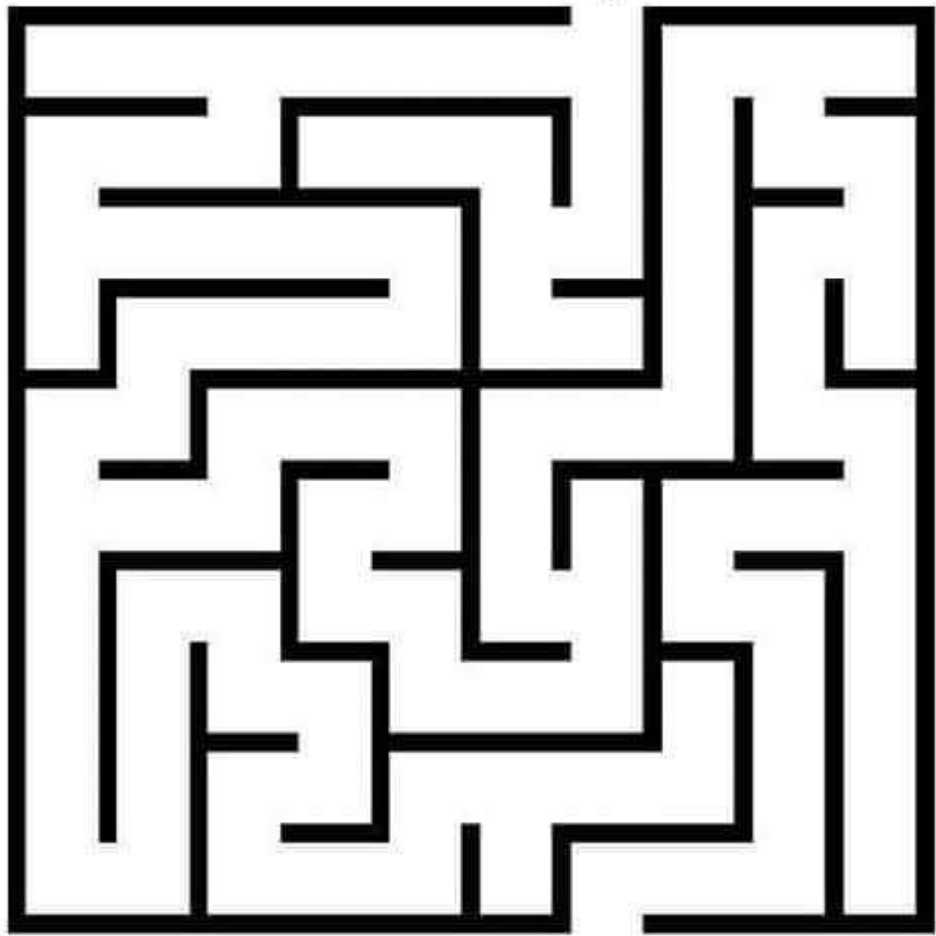
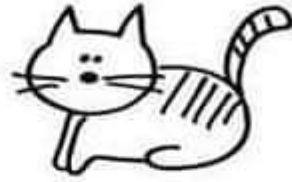

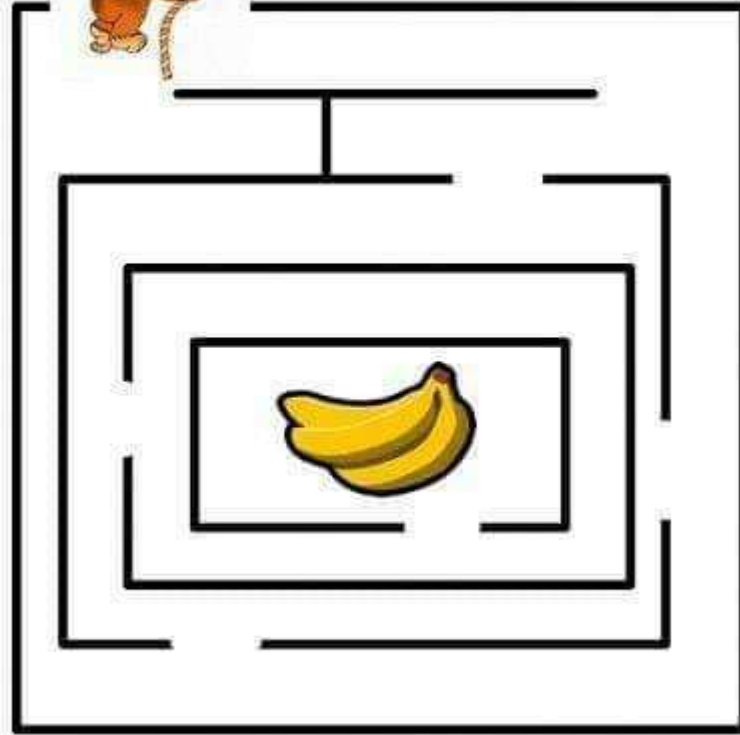

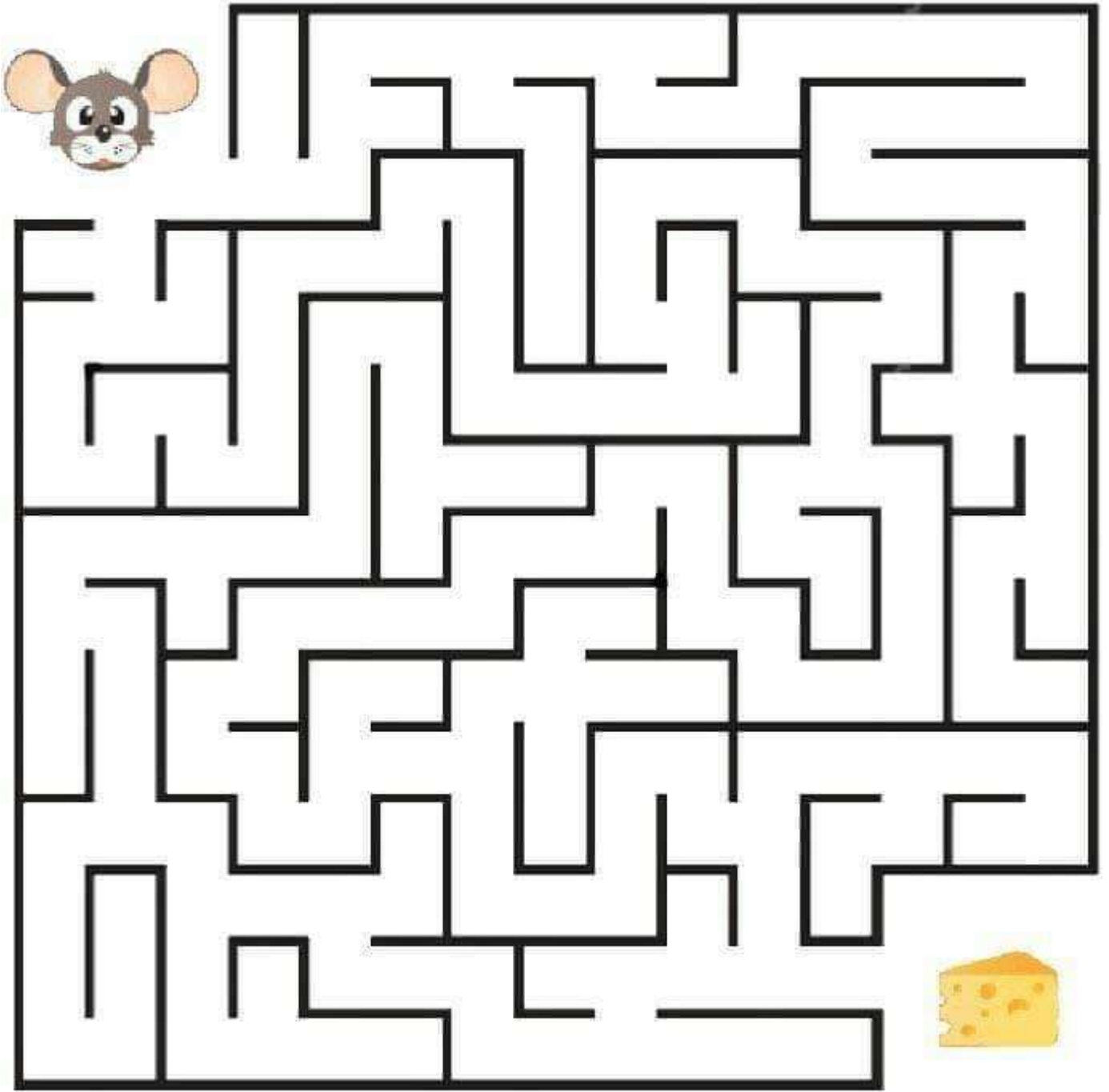



Uzima Polakovića i kćerku, Dobrićki Vozni





© 2000 by The McGraw-Hill Companies. All rights reserved. Printed in the United States of America.

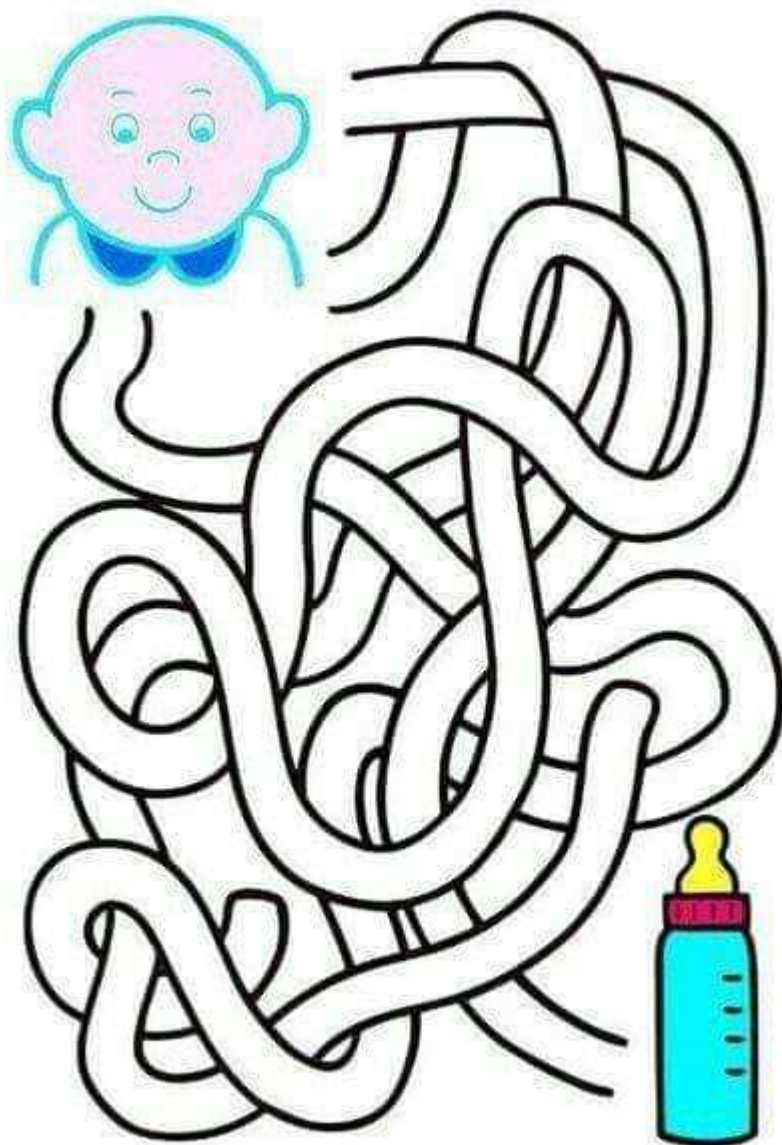

Подсказка: угадайте, куда пойдёт малыш по дорожке из лабиринта.



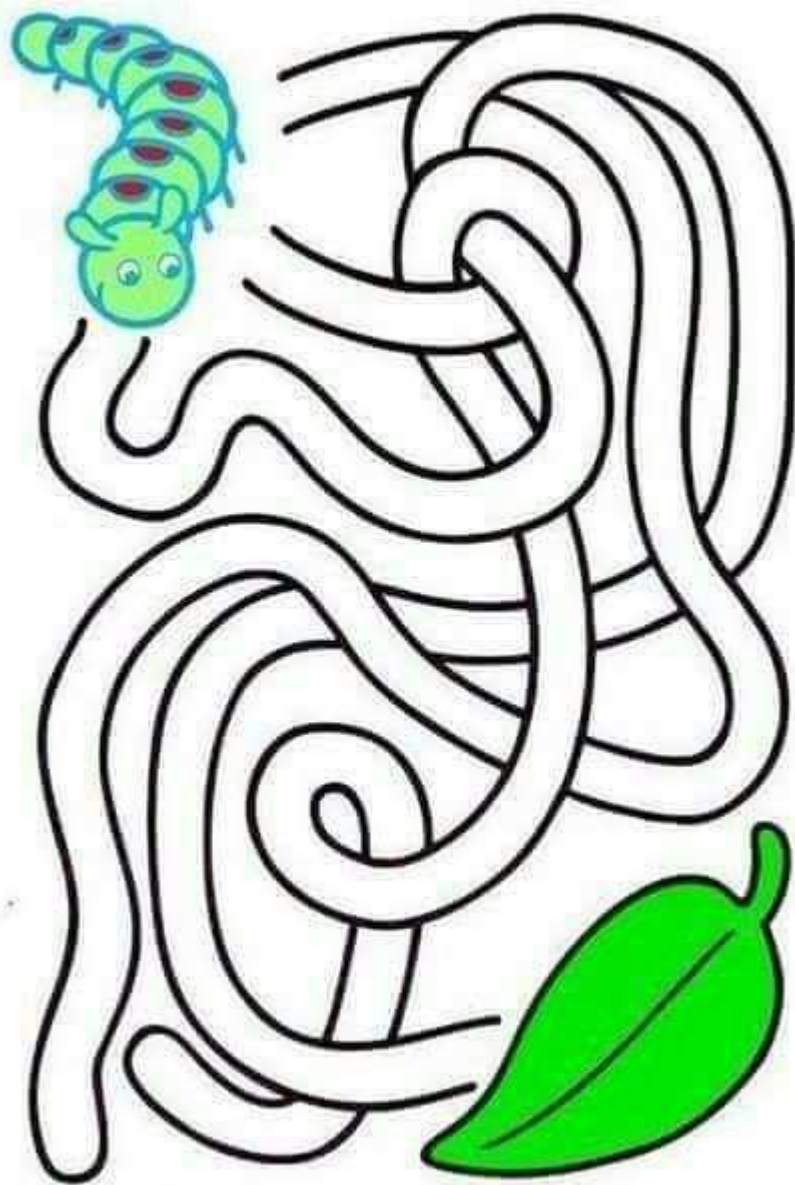

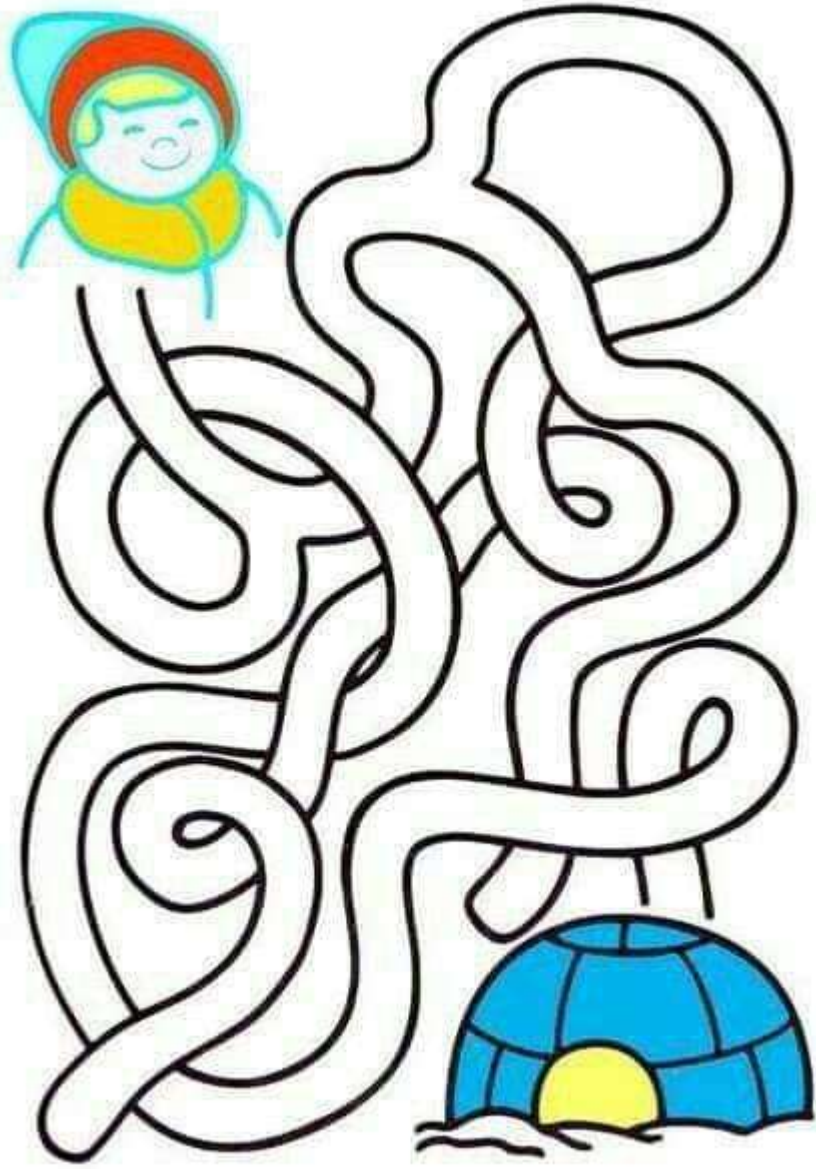

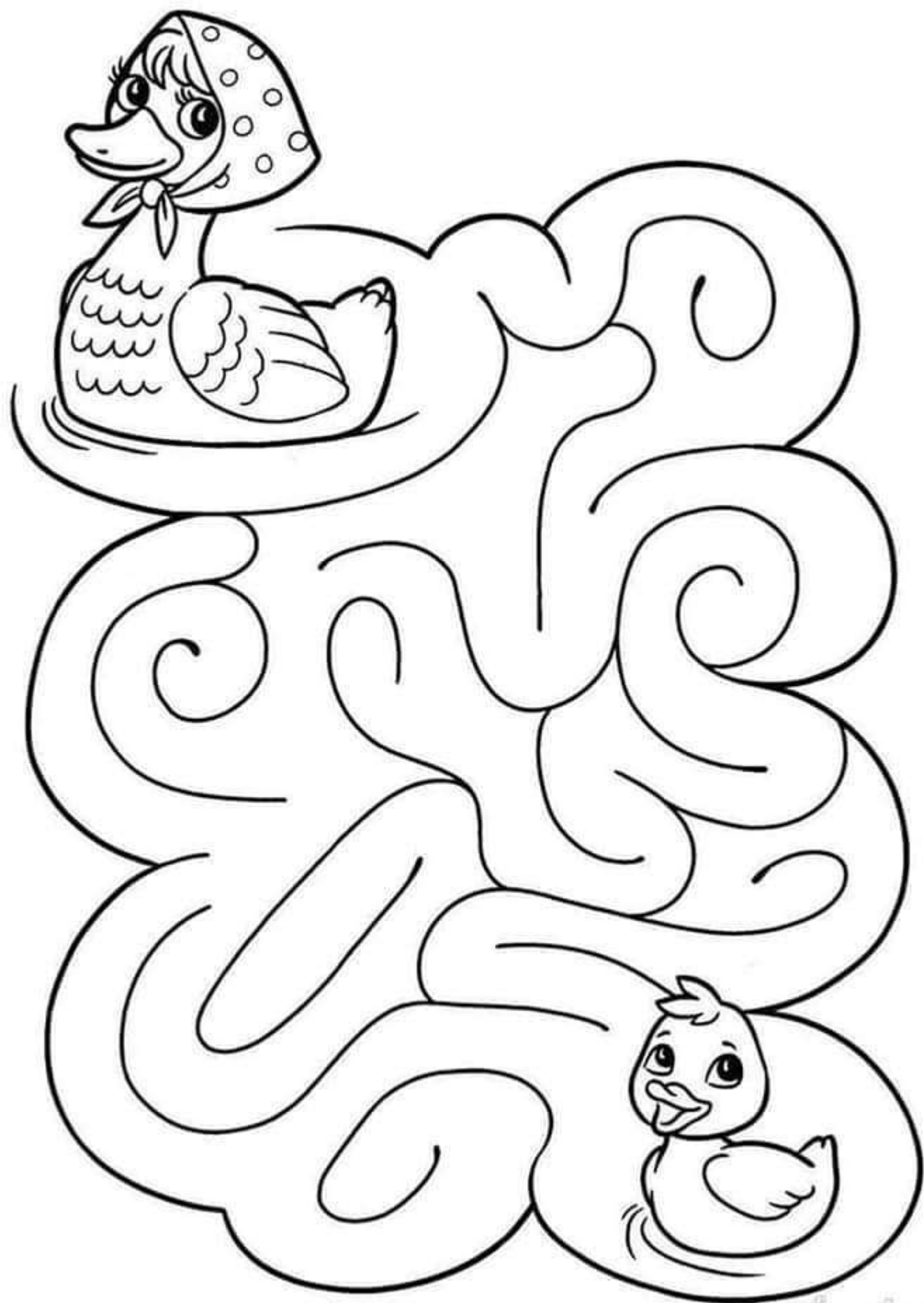

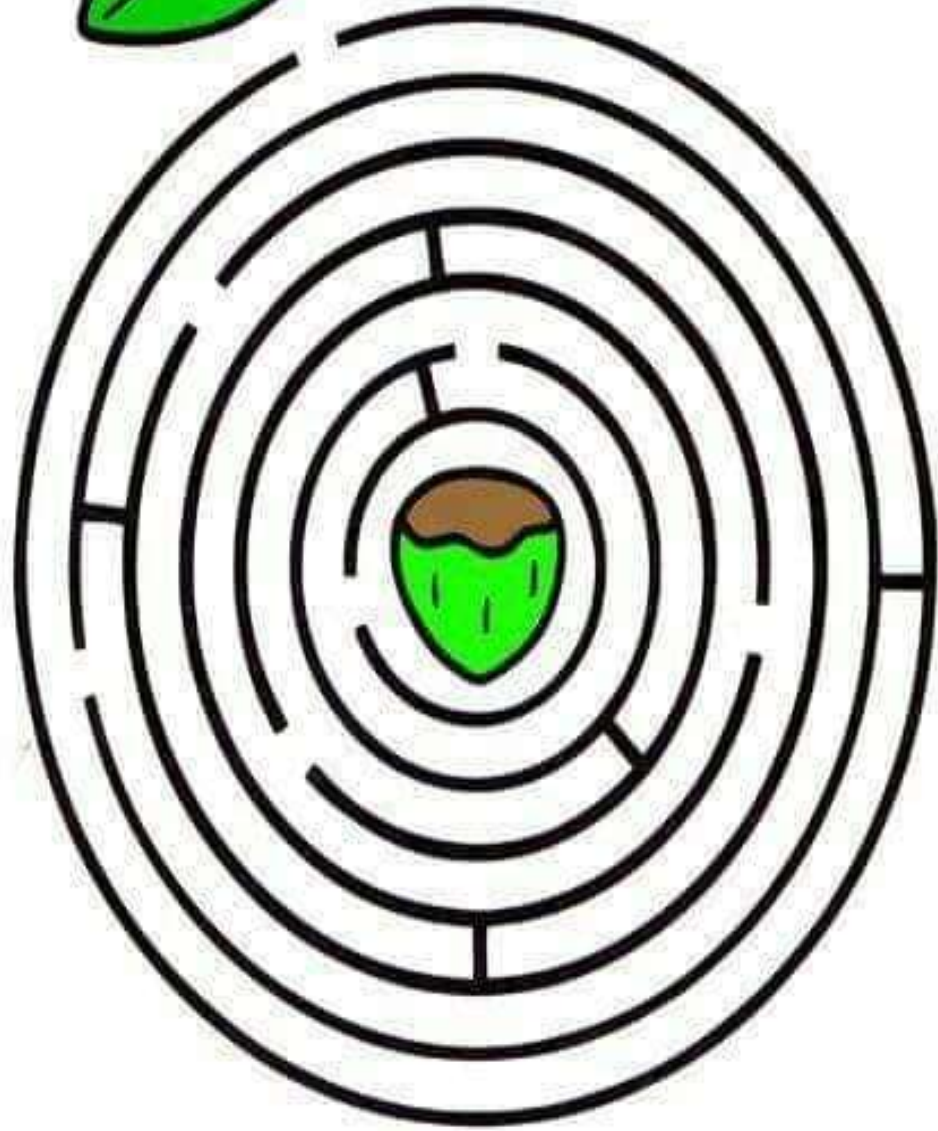
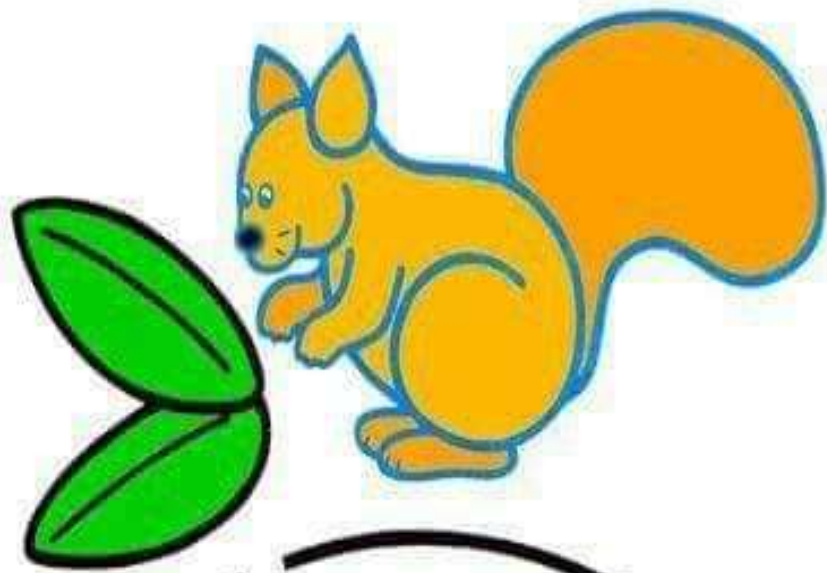

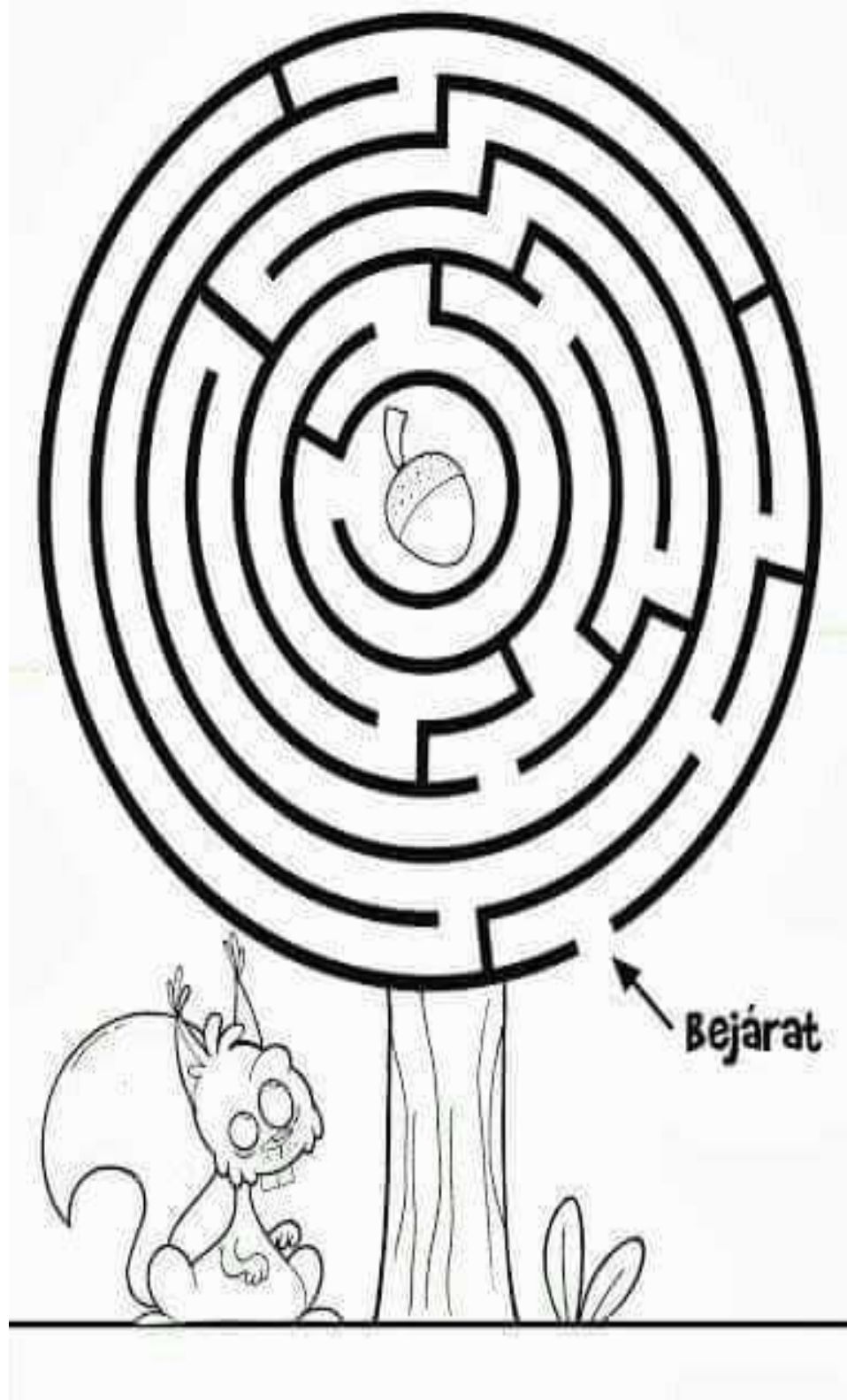

**Bejárt**



THINKMAZE.COM

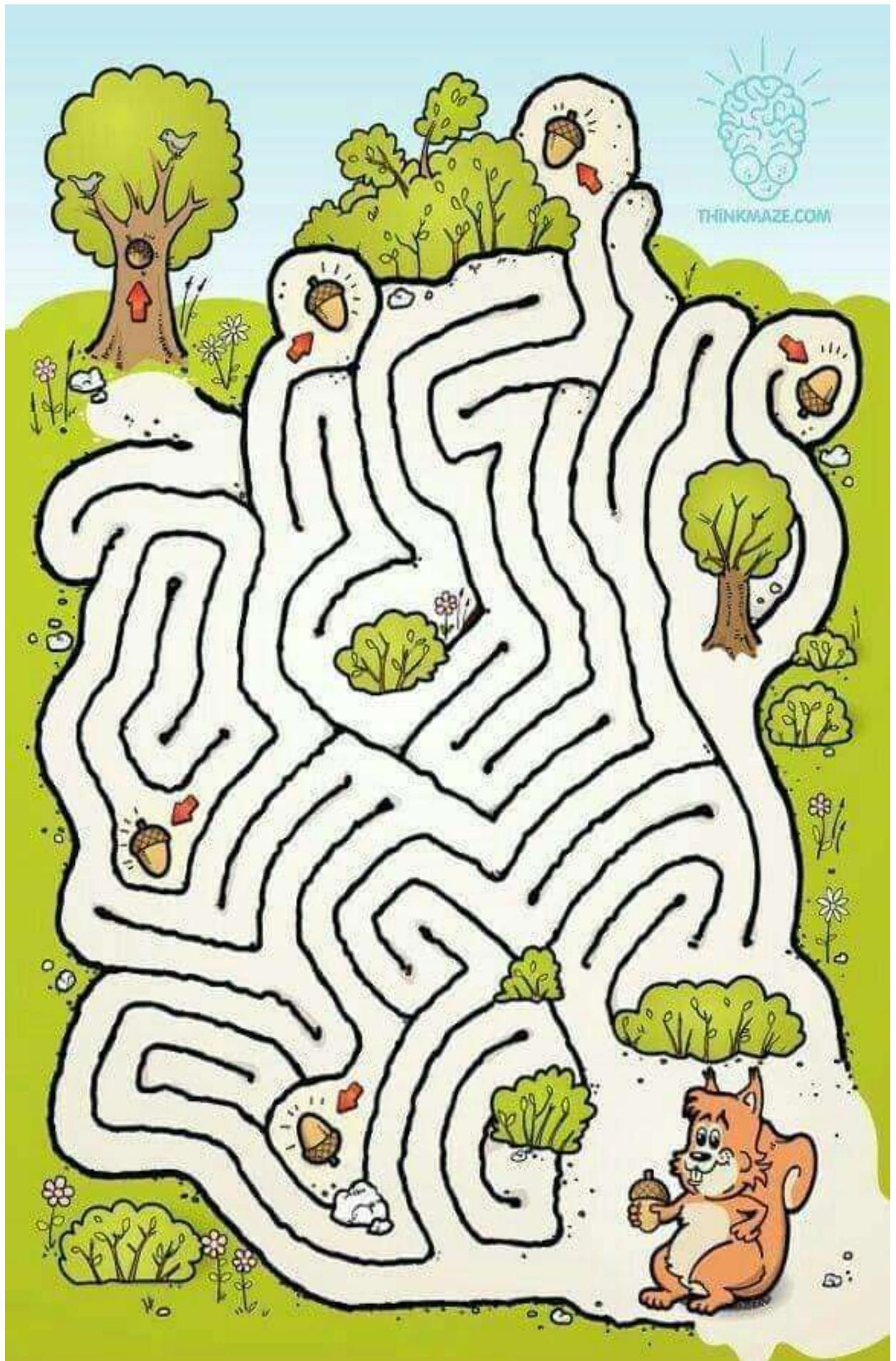

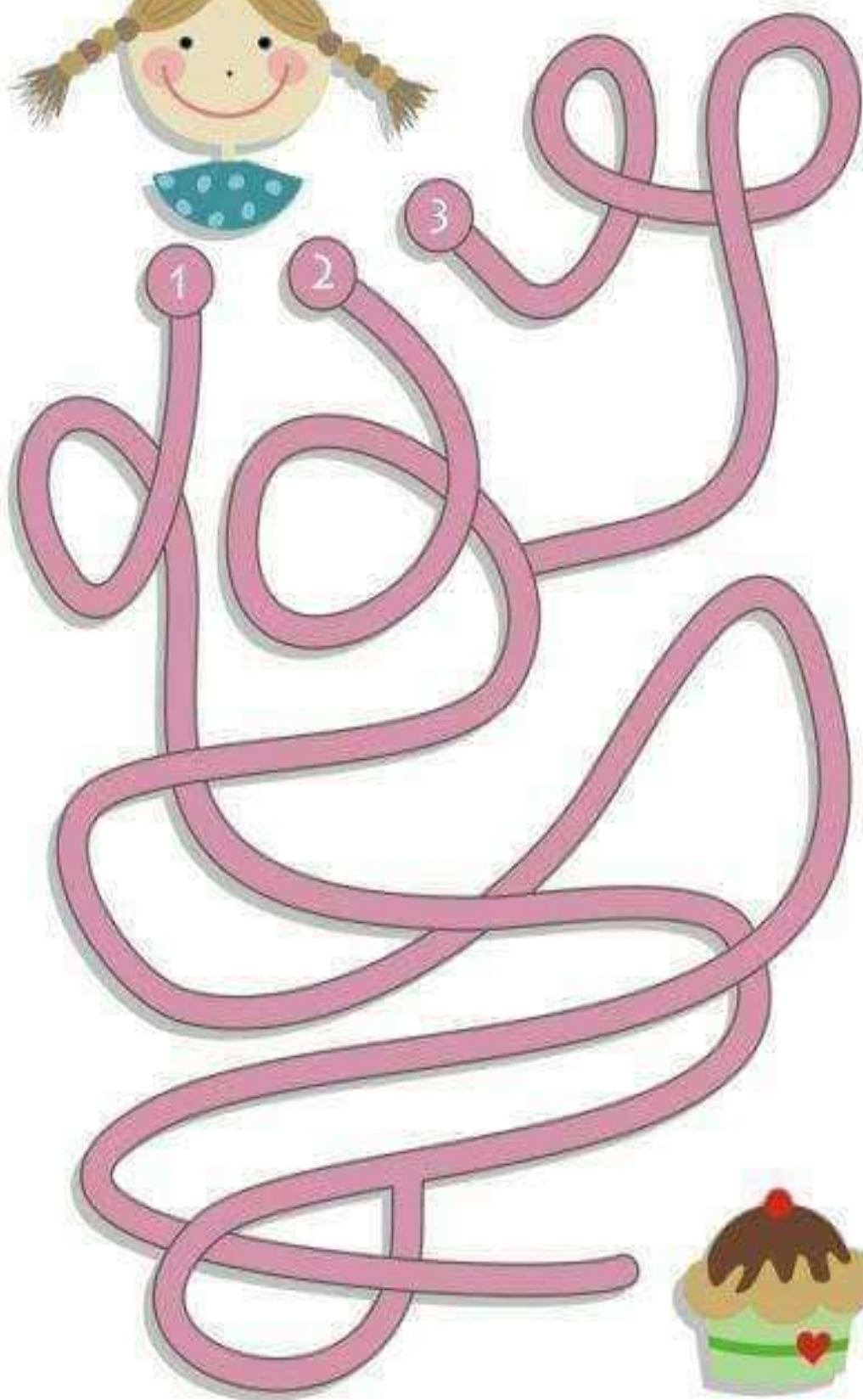

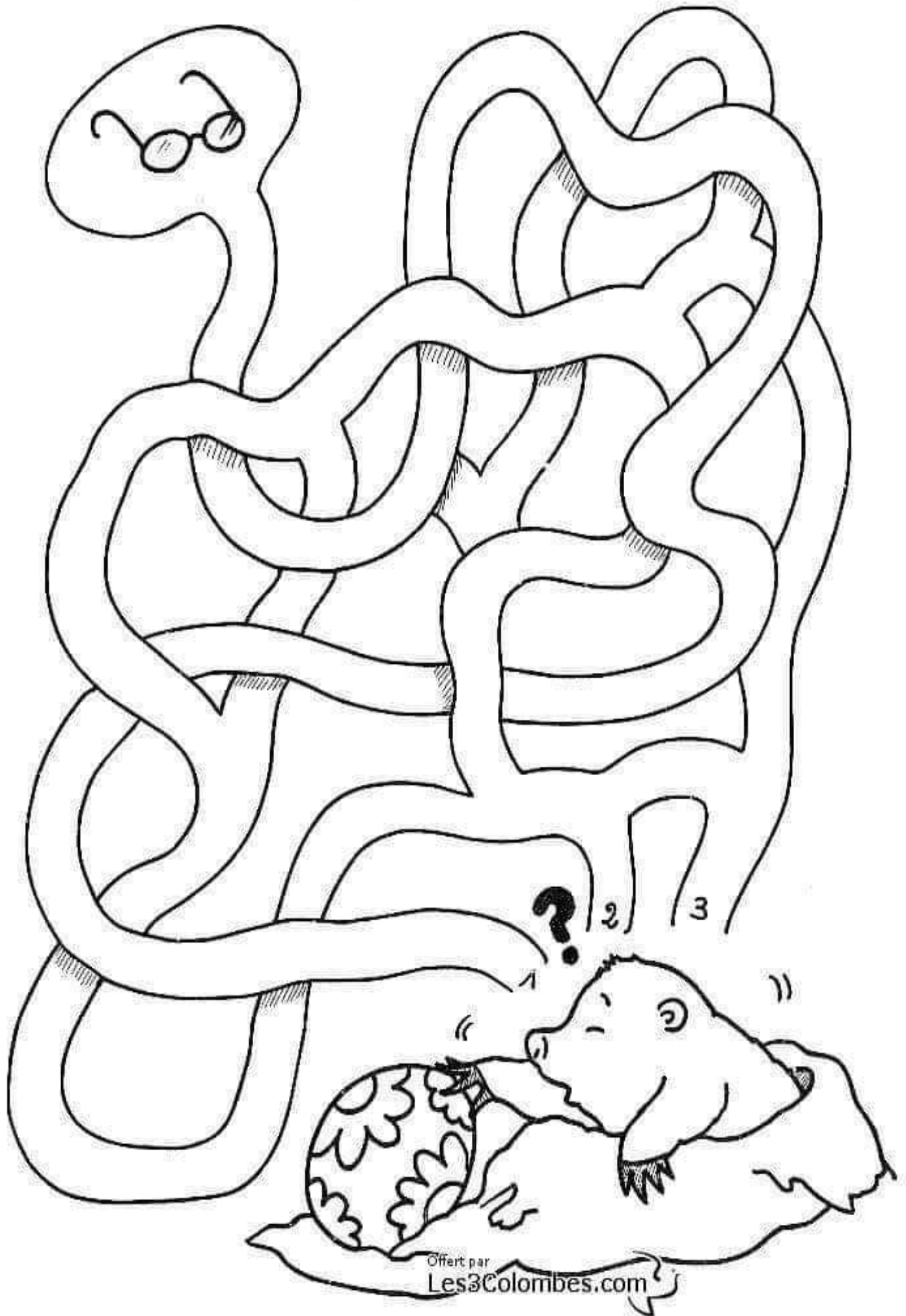



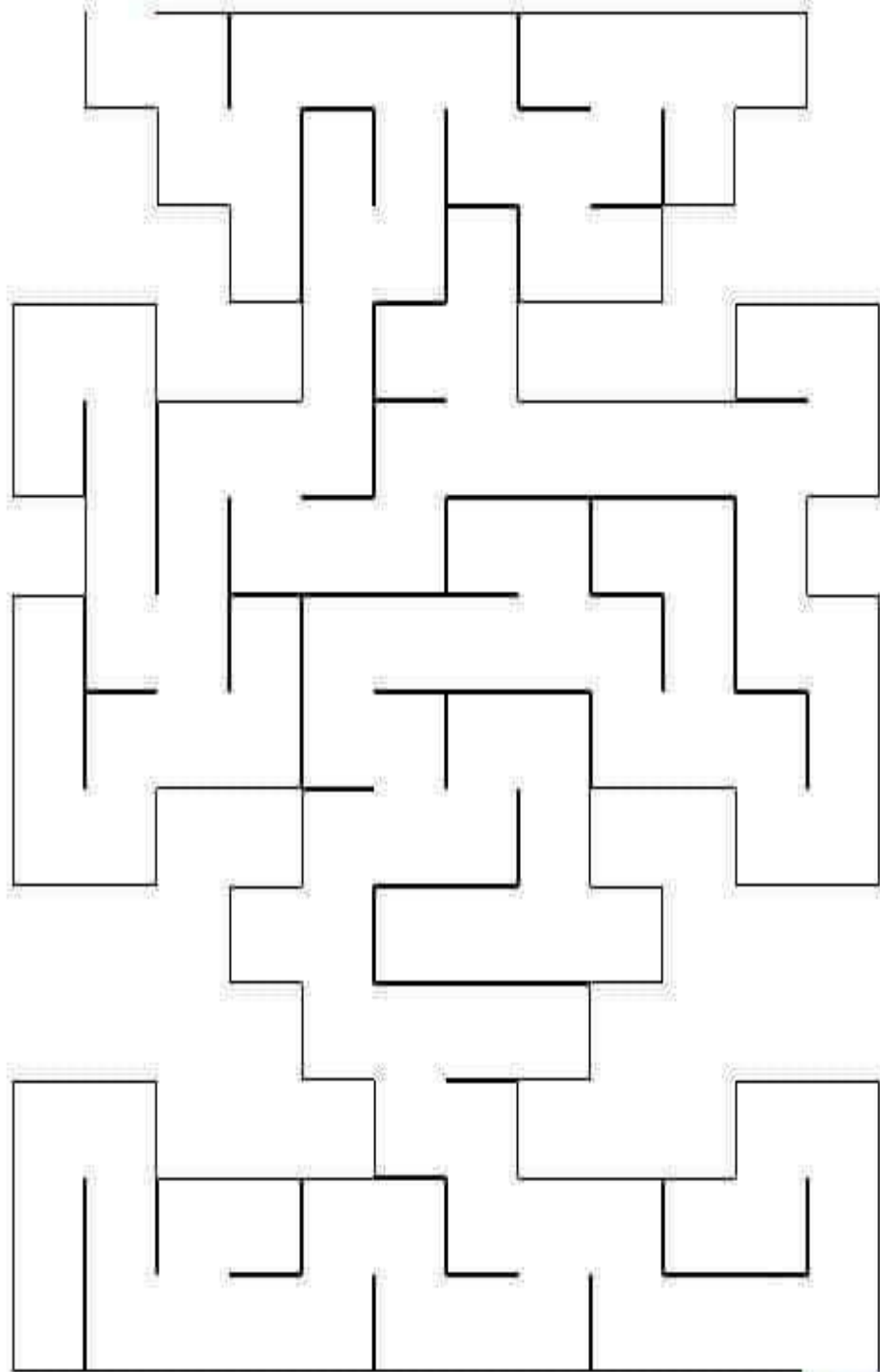

Nombre: \_\_\_\_\_

# Laberinto



Ayuda a este pitufo a llegar hasta su casa.

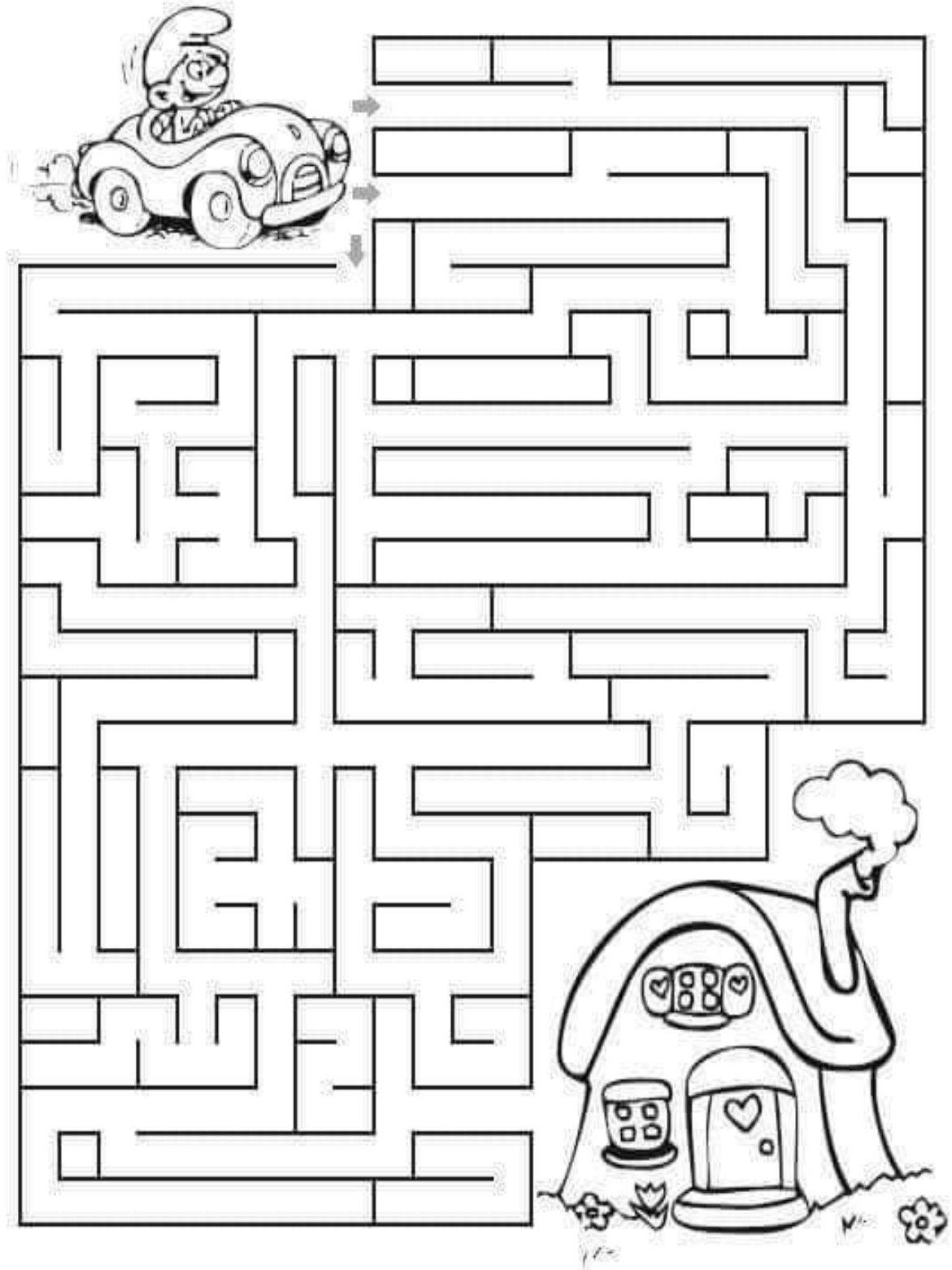

# БРОЈ ЈЕДАН

Обоји дечана и велику јединицу.  
Вежбај писање броја 1.

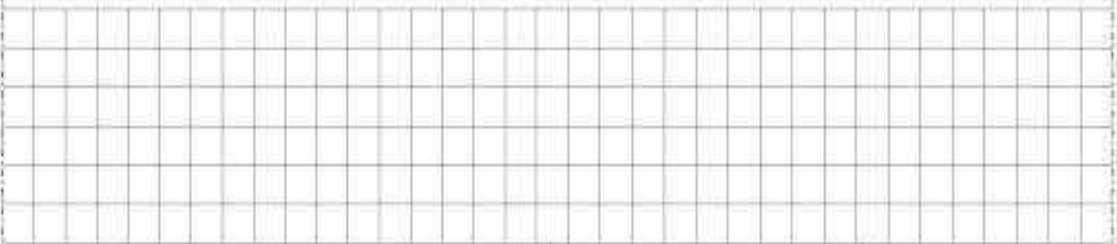

1. Обоји једну пахуљицу.

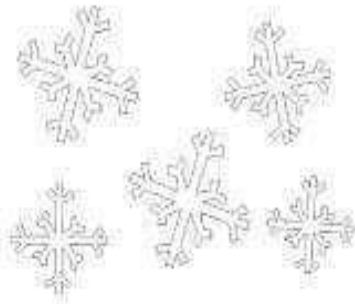

2. Прецртај све што је вишак тако да свега буде по једно. Обоји.



## БРОЈ ДВА

Обоји пилџе и велику двојку.  
Вежбај писање броја два.

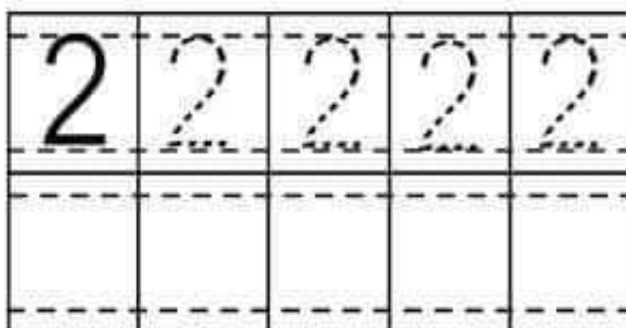

1. У сваком низу обој два бића.

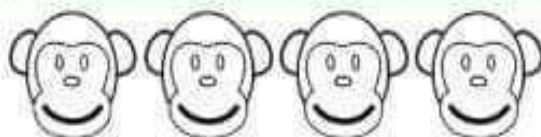

2. Обој два највећа зрна.

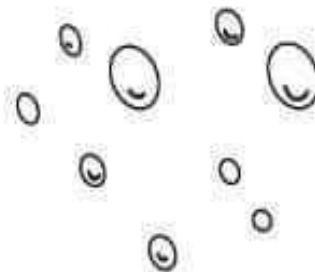

## Број 3

Обоји облаци и велику трајку.  
Вежбај писање броја 3.

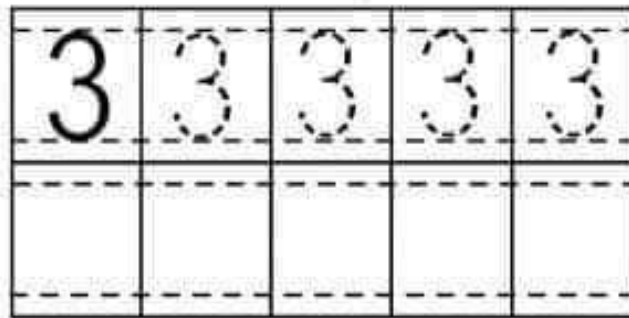

1. Обоји капи које имају три тачкице.

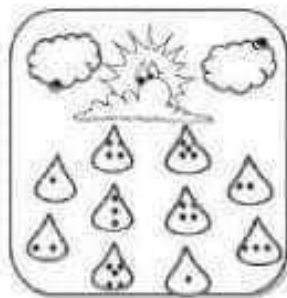

1. Обоји три птице.

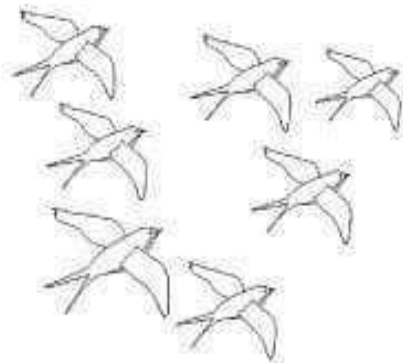

# Број 4

Обоји 4 дрвета и велику четворку. Вежбај писање броја 4.

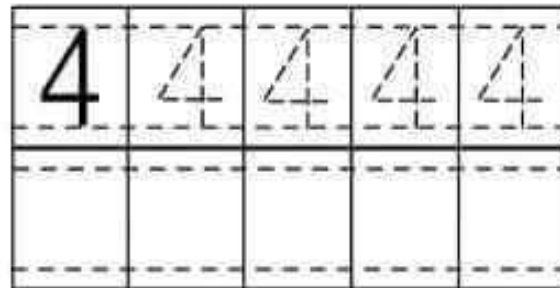

1. Повежи.

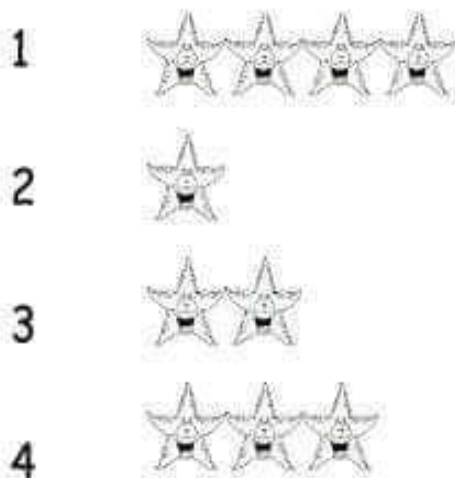

2. Обоји четири веверице.

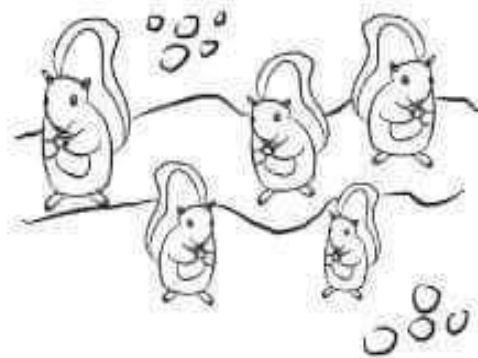

# Број 5

Обоји 5 Снежко Белића и велику петицу. Вежбај писање броја 5.

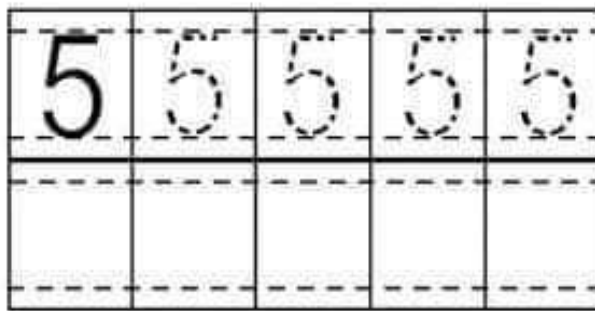

1. Прebroј објекте и заокружи број.

	4 3 5
	1 3 2
	3 1 2
	3 2 1
	4 5 3

2. Обоји пет метли.



## Број 6

Обоји чега има шест и велику шестицу. Вежбај писање броја 6.

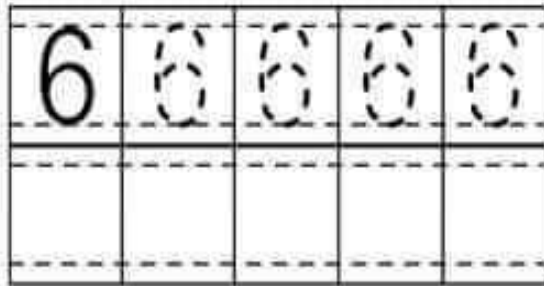

1. Обоји скуп објеката којих има кад што приказује број.



2. Обоји шест листова.

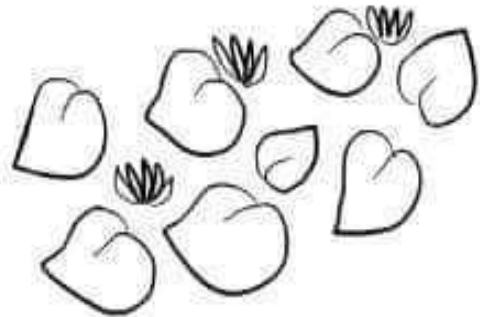



# Број 7

Обоји седам планина и велику седмицу. Вежба писање броја 7.

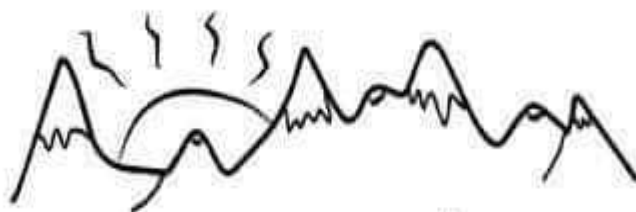

1. Прebroј и заокружи одговарајући број.

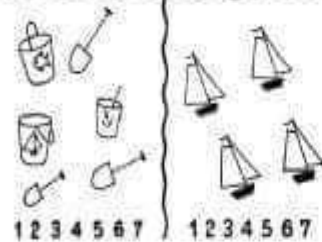
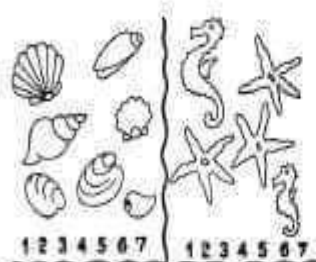

2. Обоји седам жирафица.

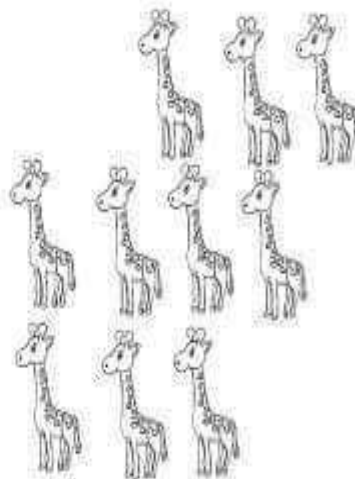

# Број 8

Обоји осам шешира и велику осмицу. Вежбај писање броја 8.

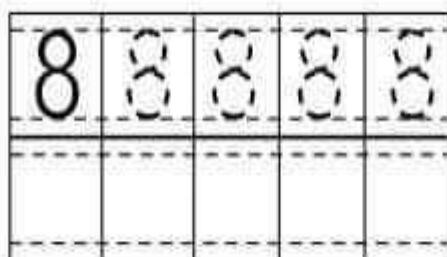

1. Обоји оно чега има колико показује број.

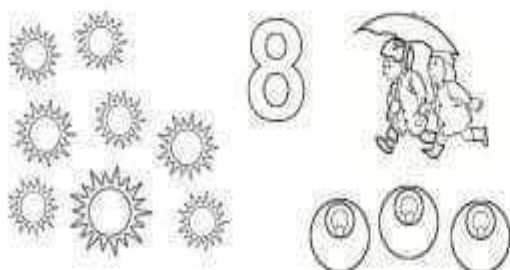

2. Обоји осам гусеница.

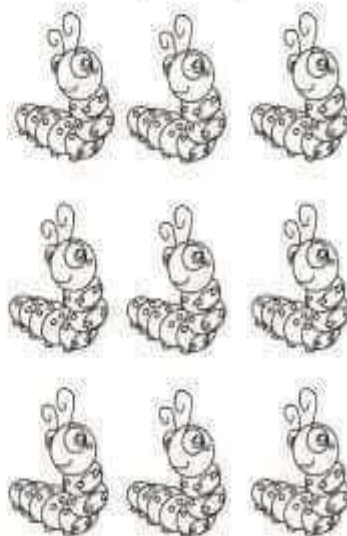

## Број 9

Обоји лептириће и велику деветку. Вежбај писање броја 9.

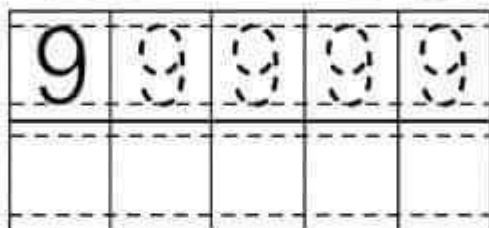
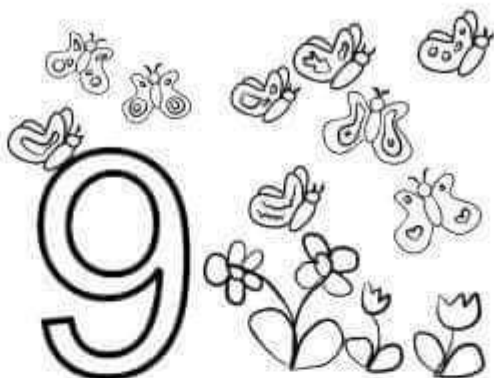

1. Споји тачке са бројевима од 1 до 9.

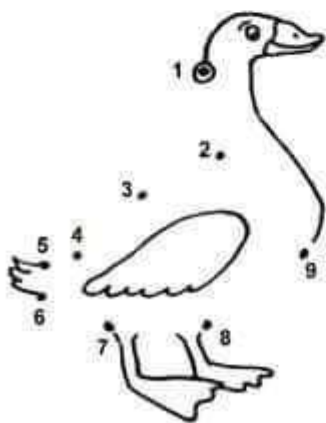

2. Обоји оно чега има девет.



# Број 10

Обоји јабуке и велику десетку. Вежбај писање броја 10.

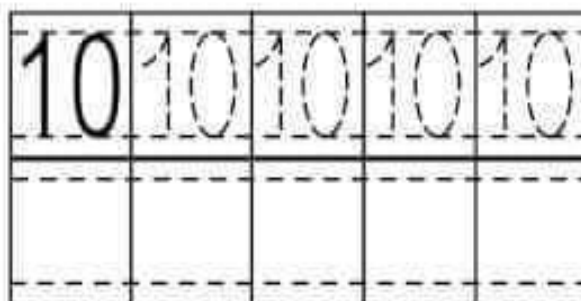
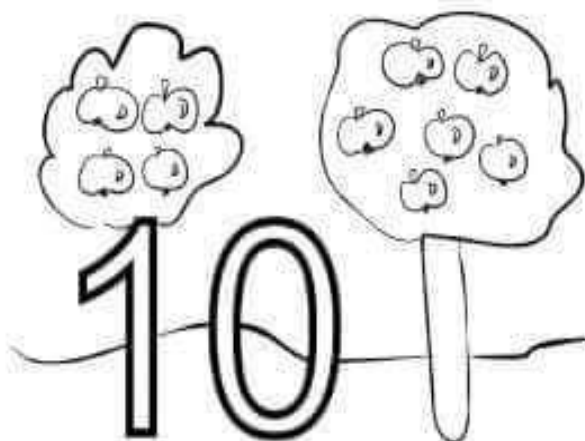

1. Прebroј и заокружи одговарајући број.

	6 7 8 9
	6 7 8 9
	7 8 9 10
	6 7 8 9
	7 8 9 10
	6 7 8 9

2. Прebroј и упиши.

